

ADA HEADZ



adaheadz.io/manuals

PLUTUS



2x



2x



4x



1x



1x



1x



1x



1x



1x



1x



4x



1x



2x



12x



2x



2x

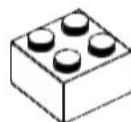

2x

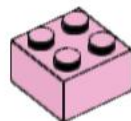

1x



2x



4x



4x



4x



4x

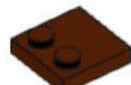

2x

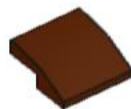

10x



3x



4x



1x



2x



1x



3x



6x



2x



4x



8x

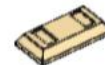

2x

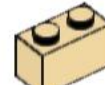

2x



1x

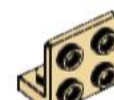

2x



2x

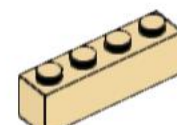

3x



2x



3x



11x



6x



4x



2x

1

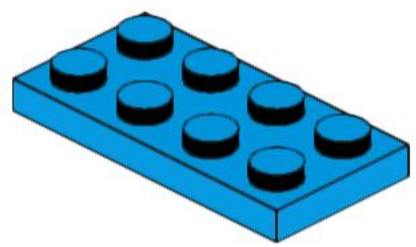
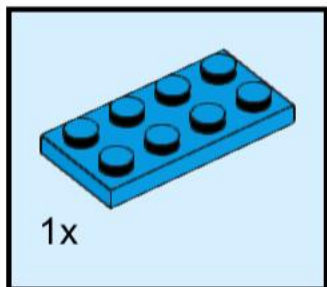

2

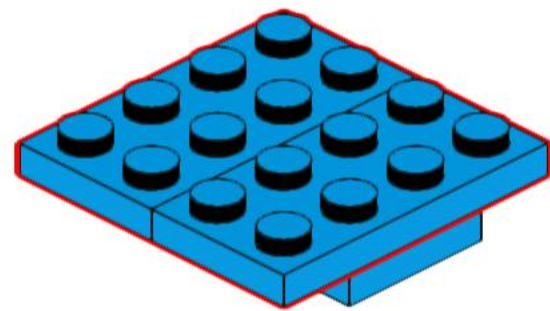
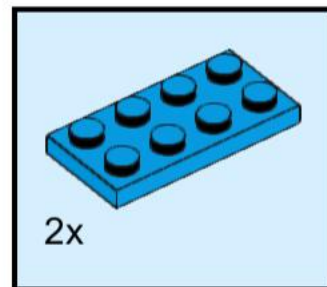

3

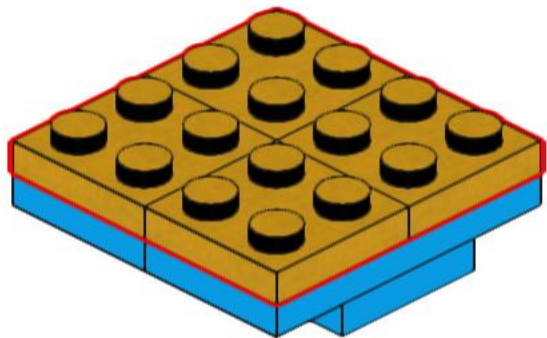
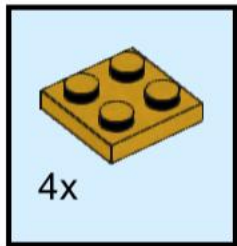

4

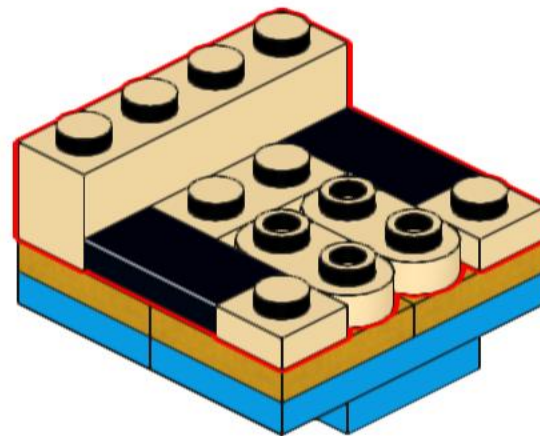
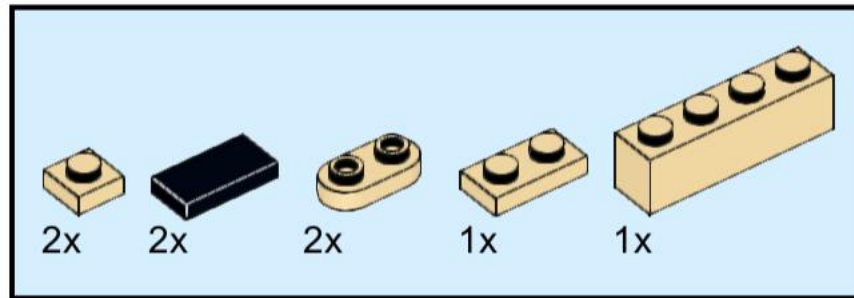

5

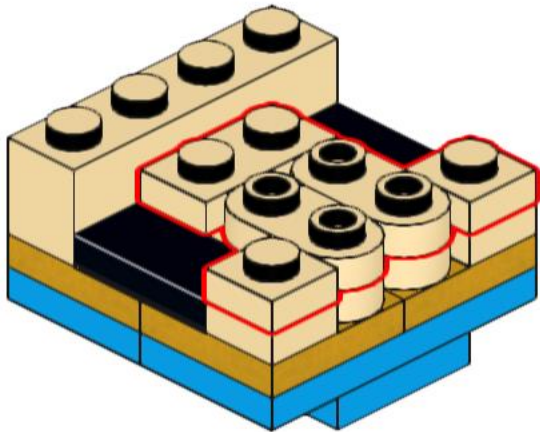
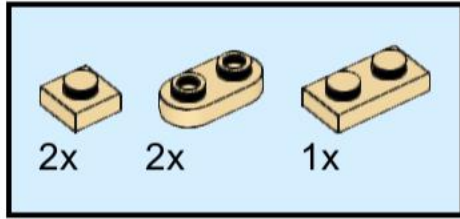

6

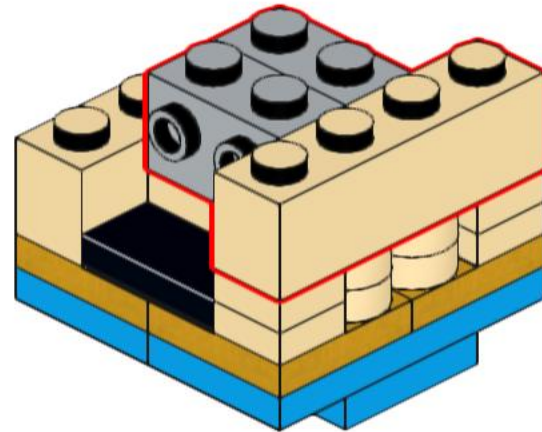
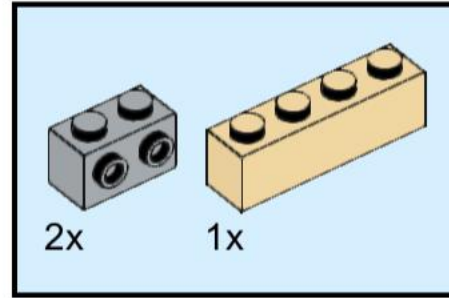

7

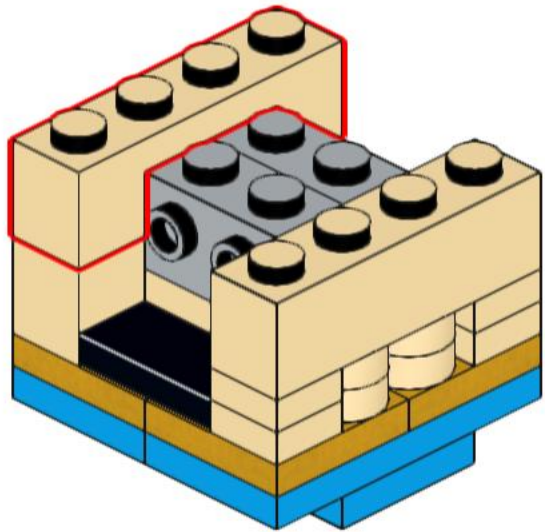
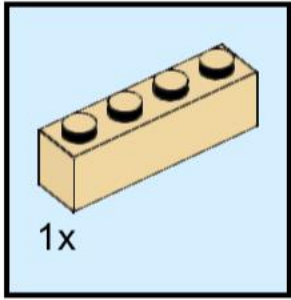

8

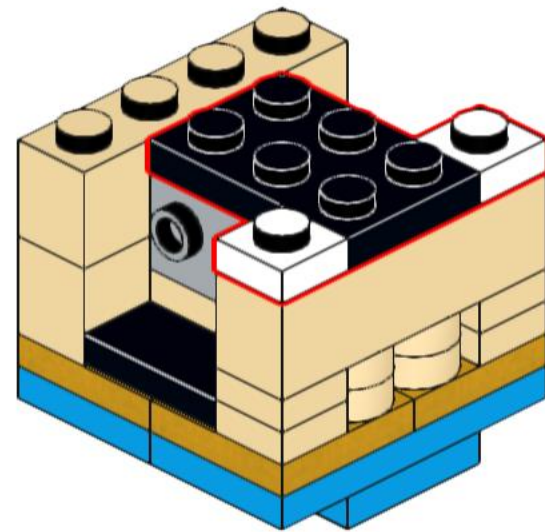
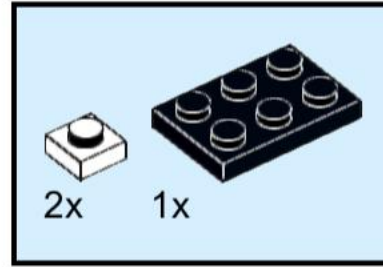

9

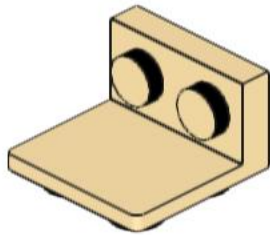
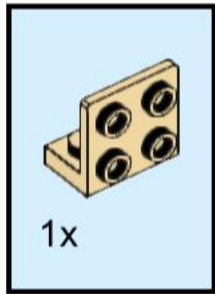

2x

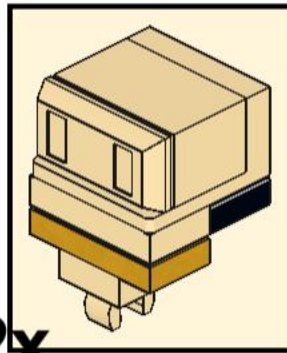

10

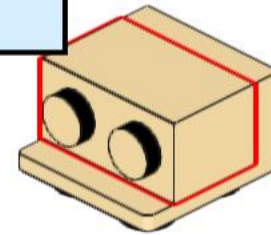
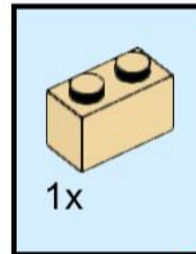

11

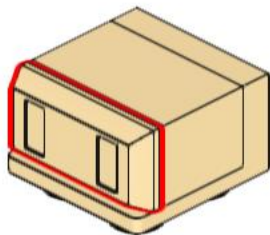
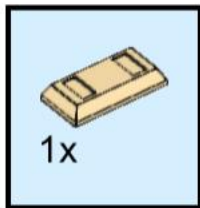

12

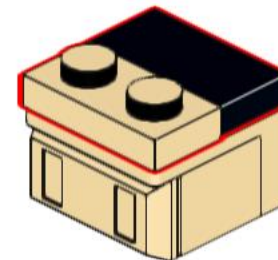
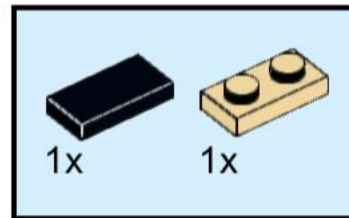

16

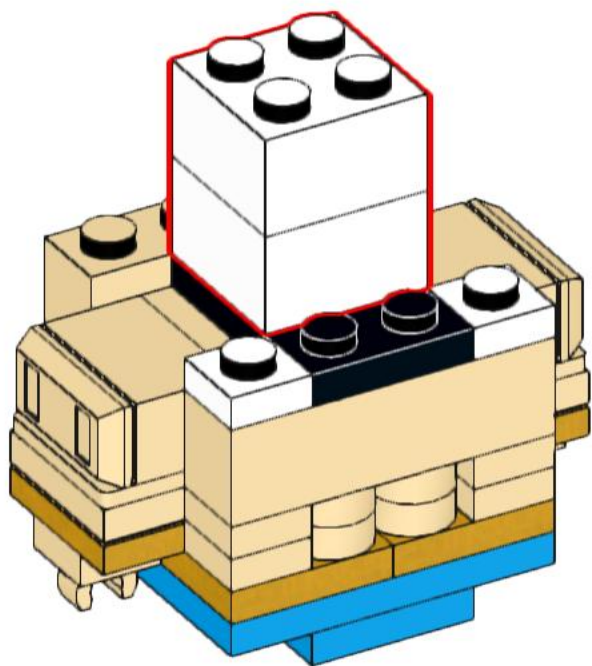
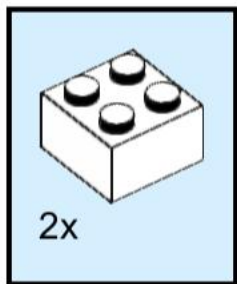

17

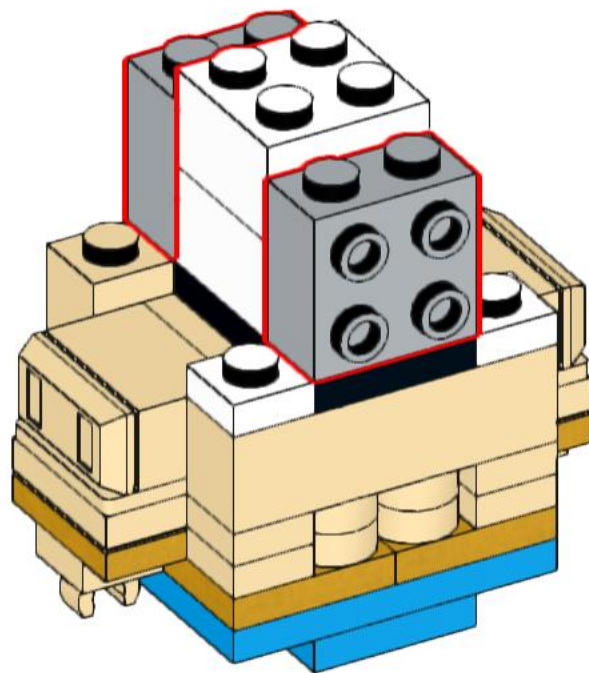
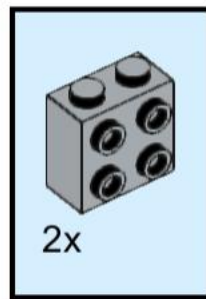

18

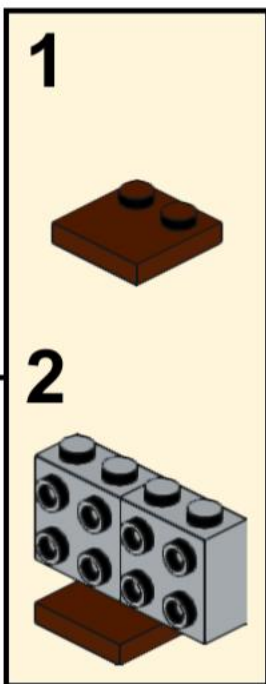
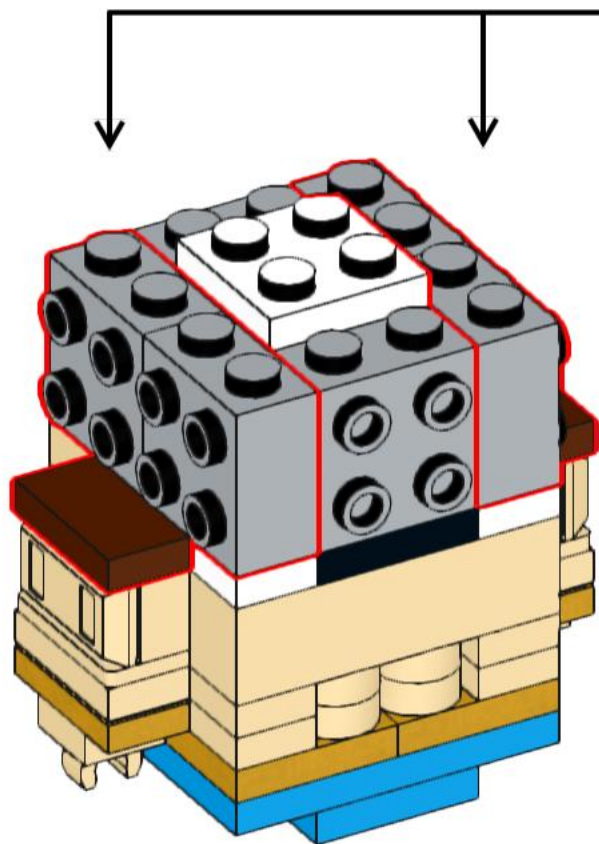
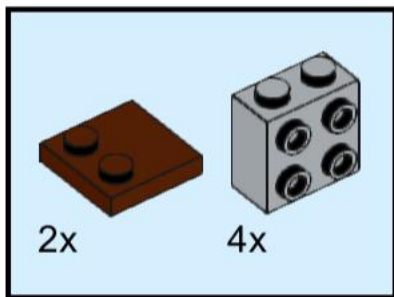

2x

19

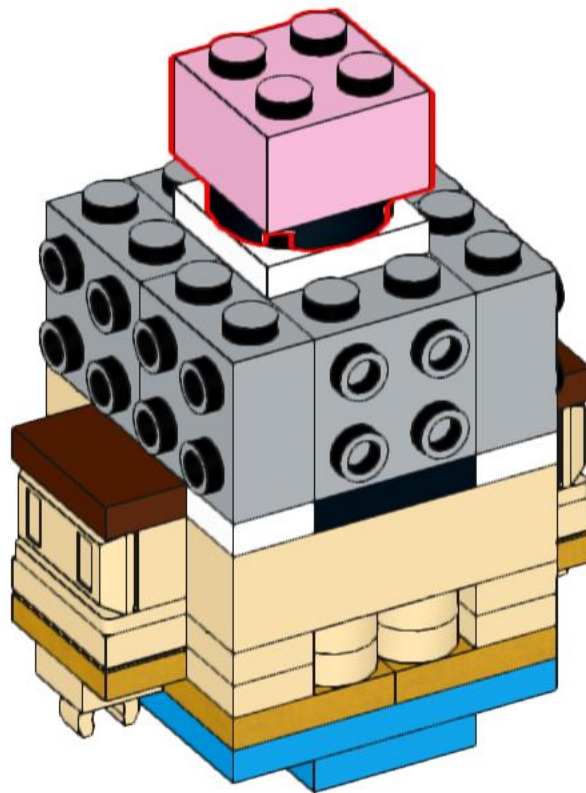
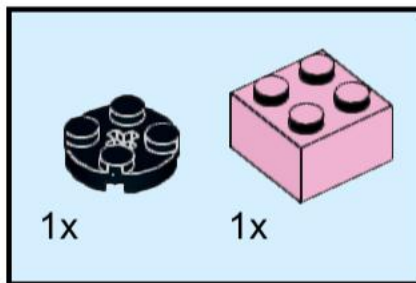

20

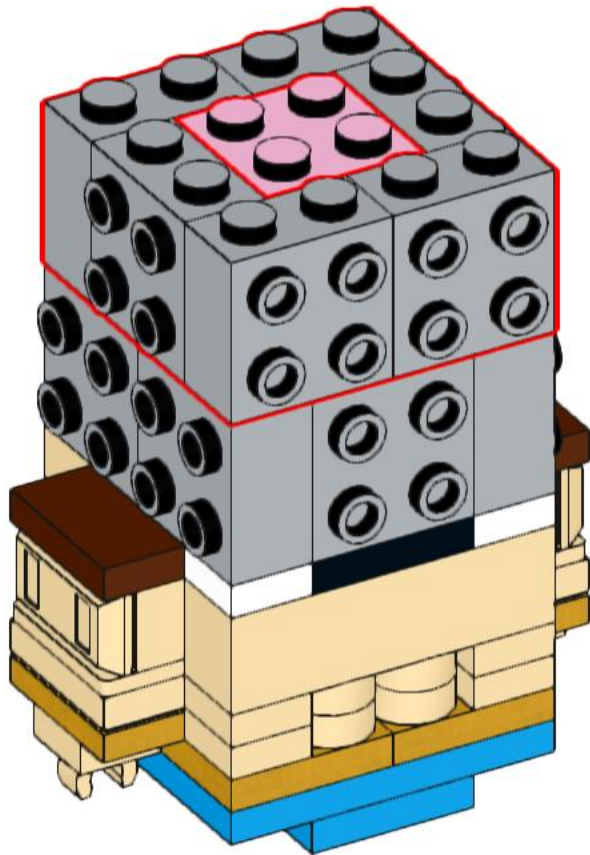
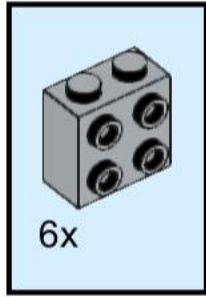

21

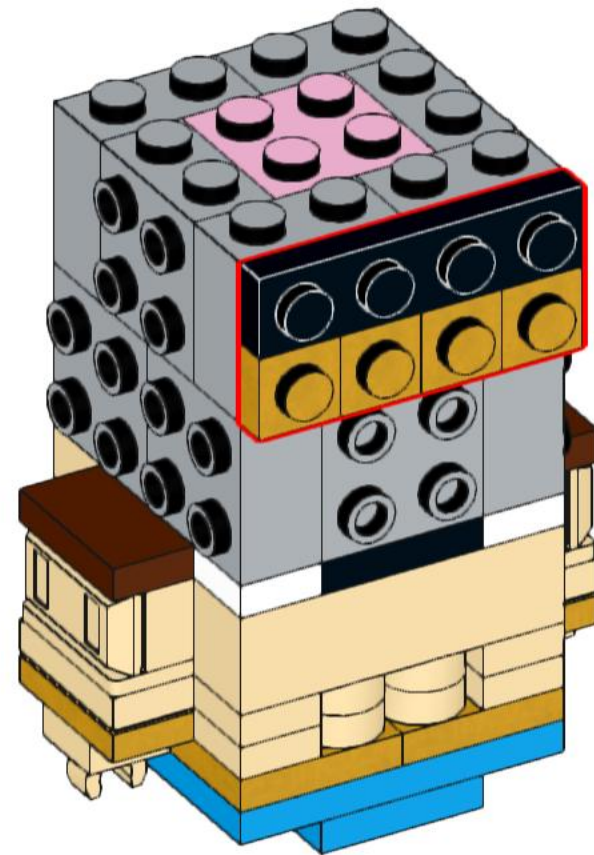
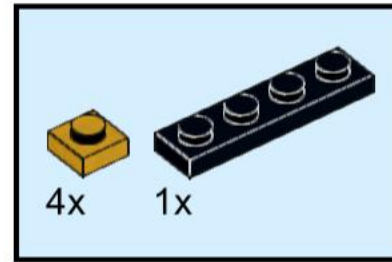

22

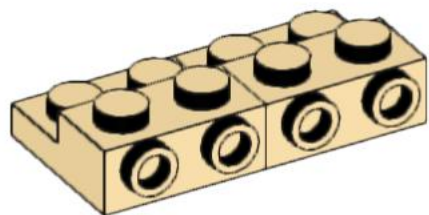
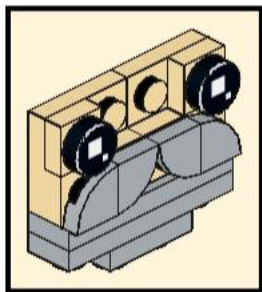
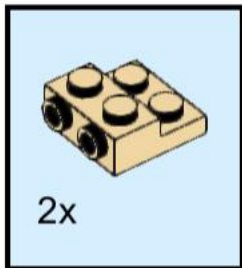

23

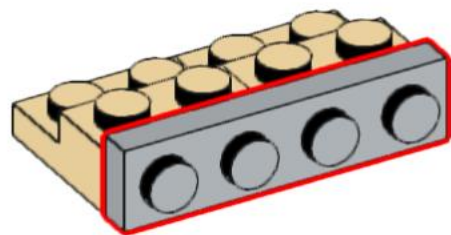
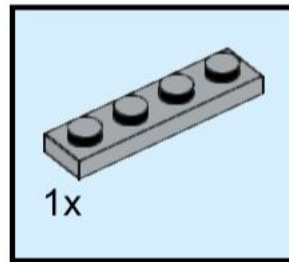

24

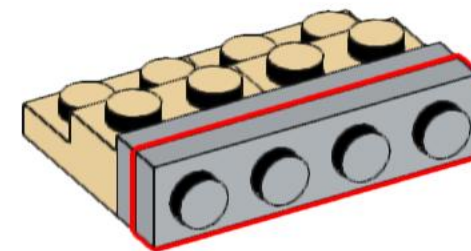
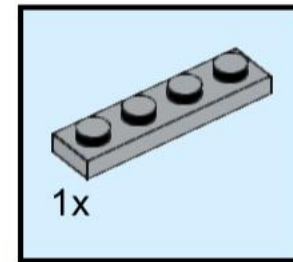

25

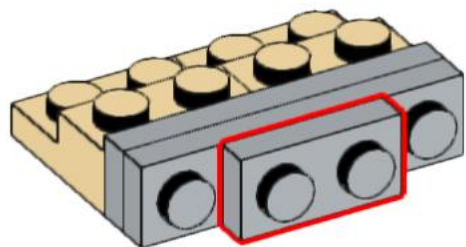
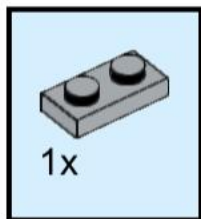

26

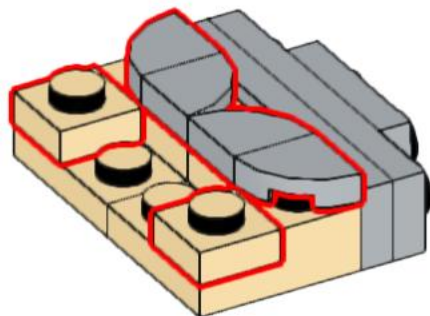
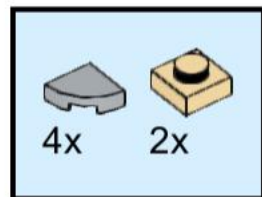

27

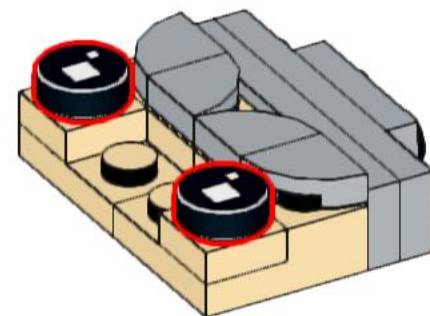

28

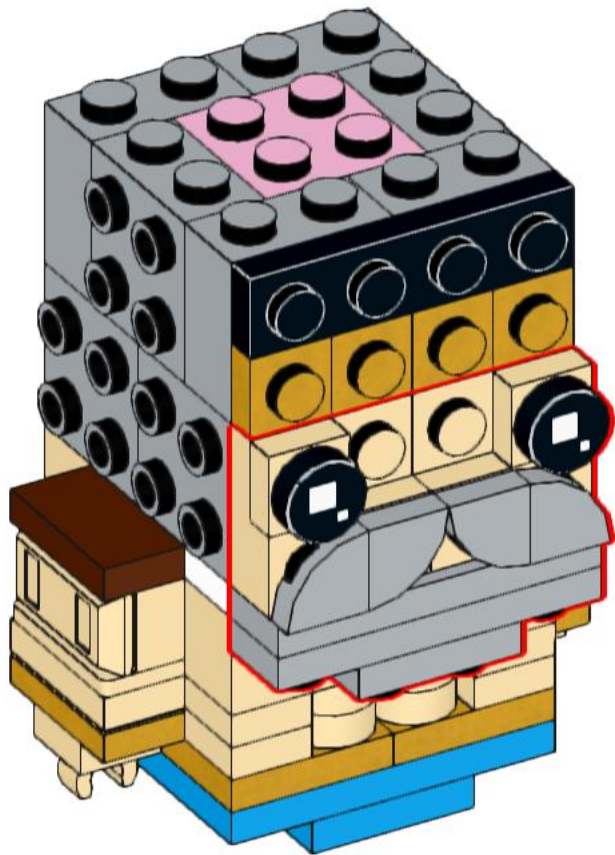

29

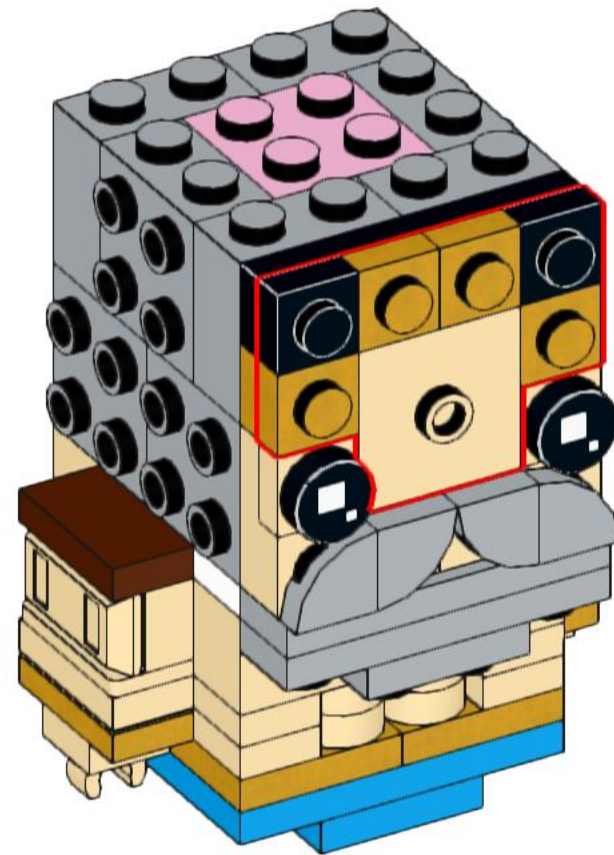
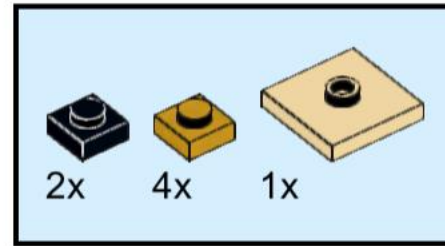

30

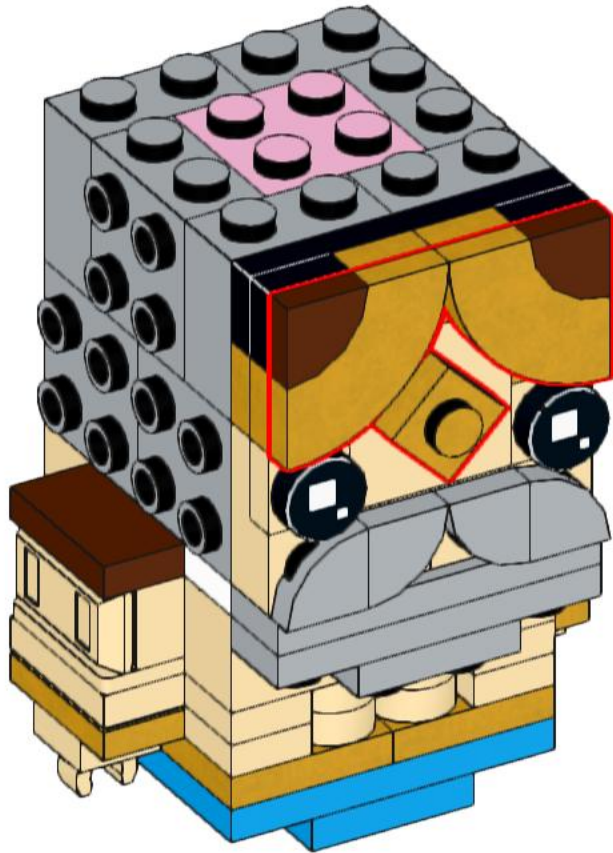
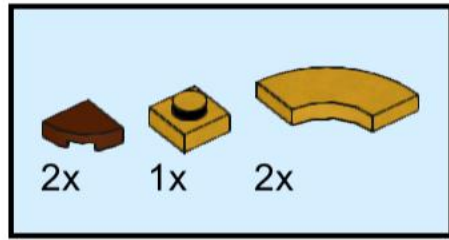

31

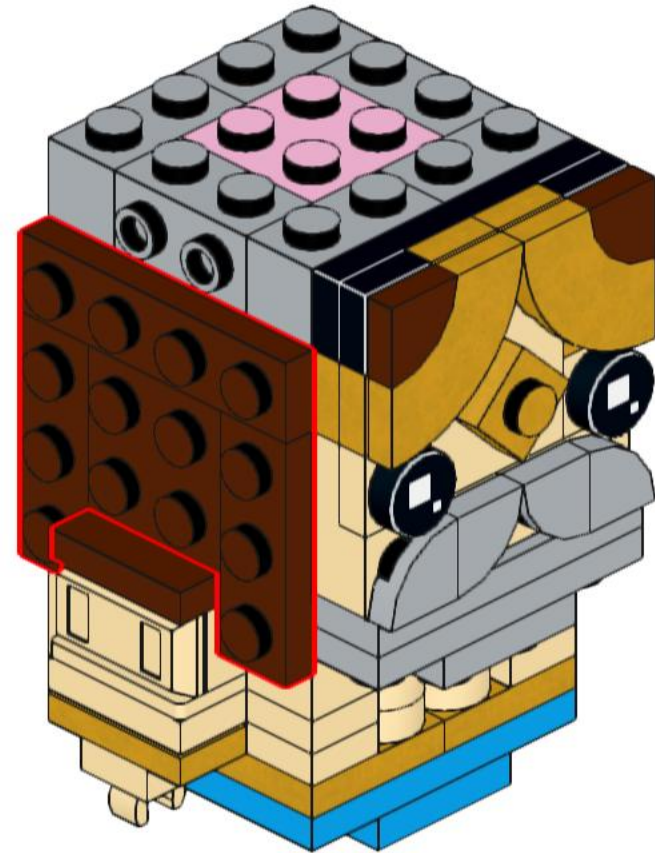
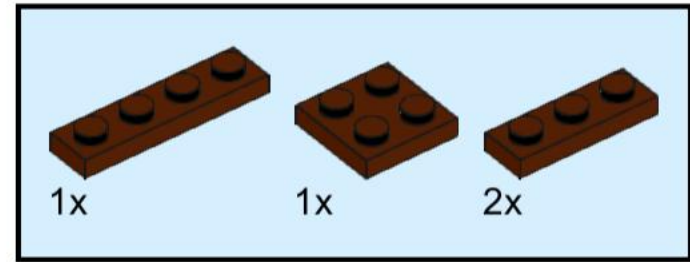

32

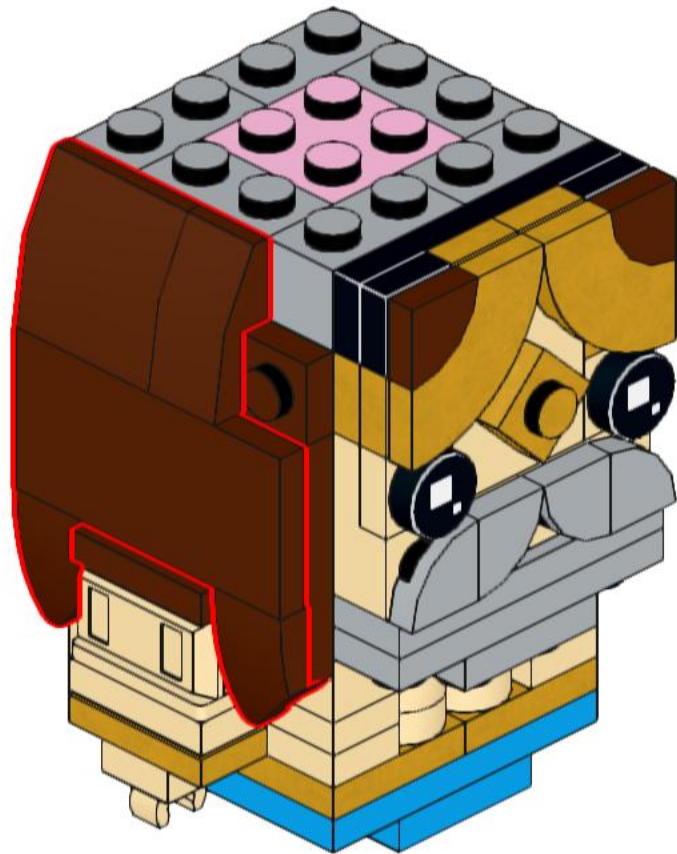
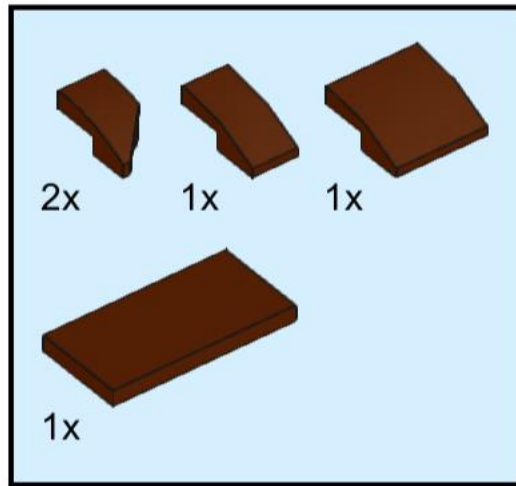

33

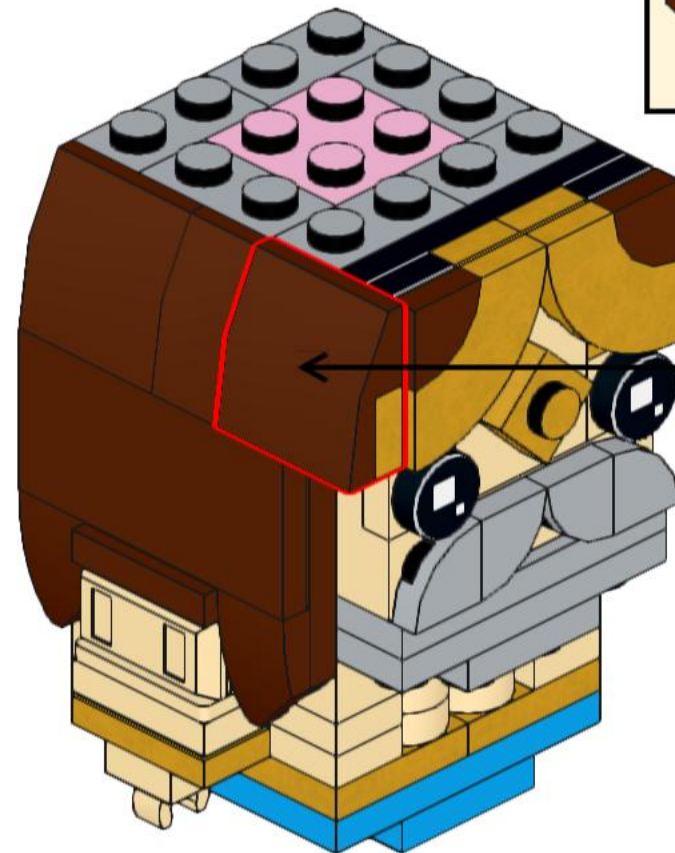
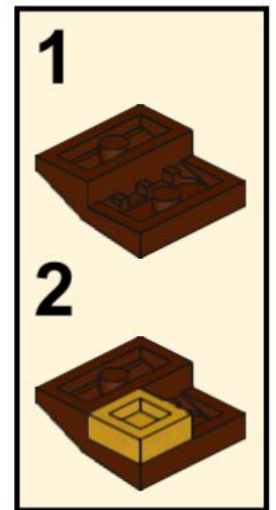
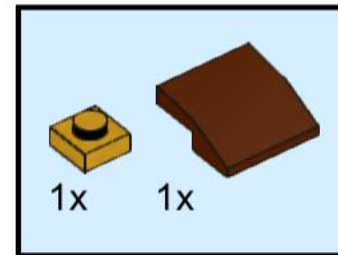

34

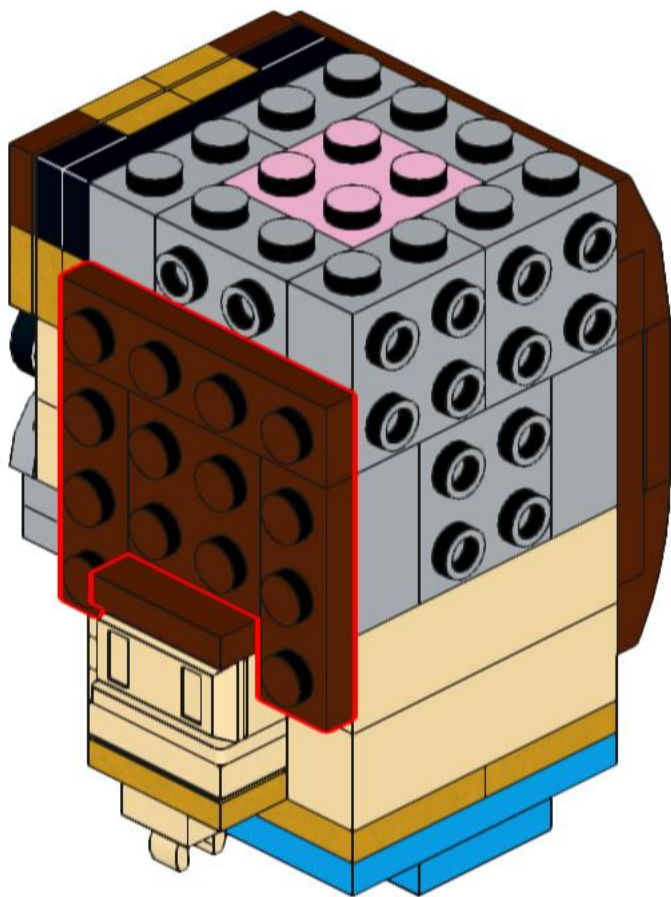
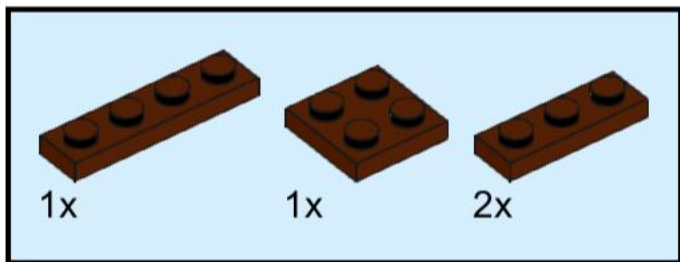

35

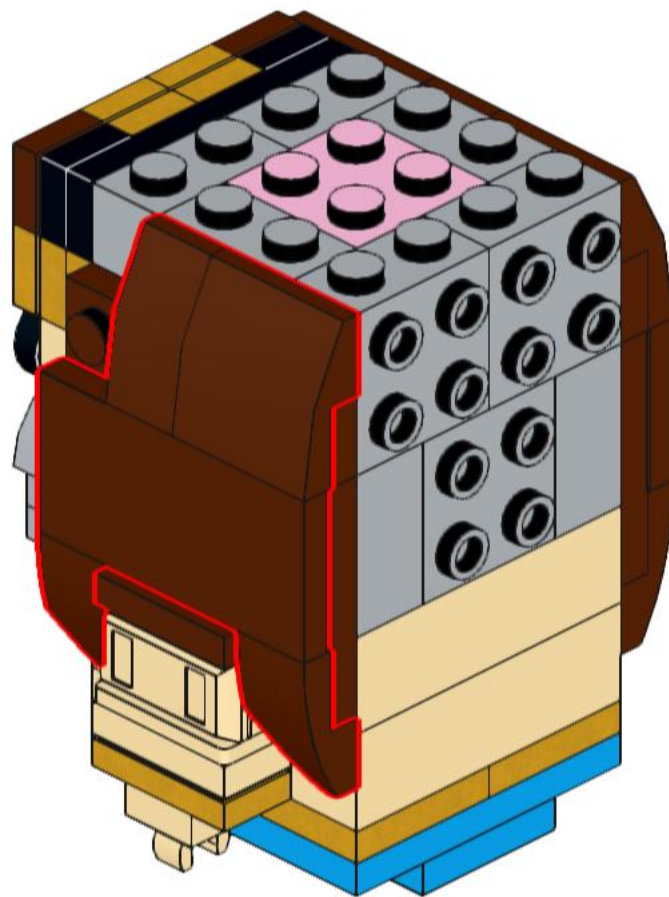
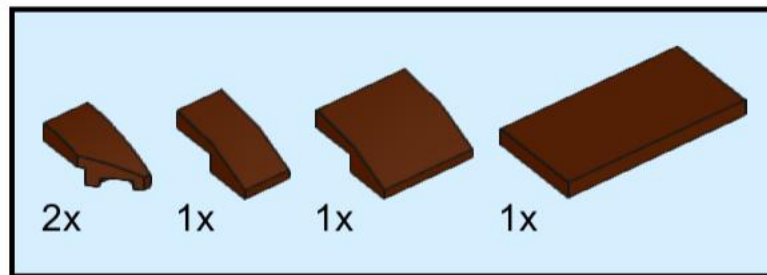

36

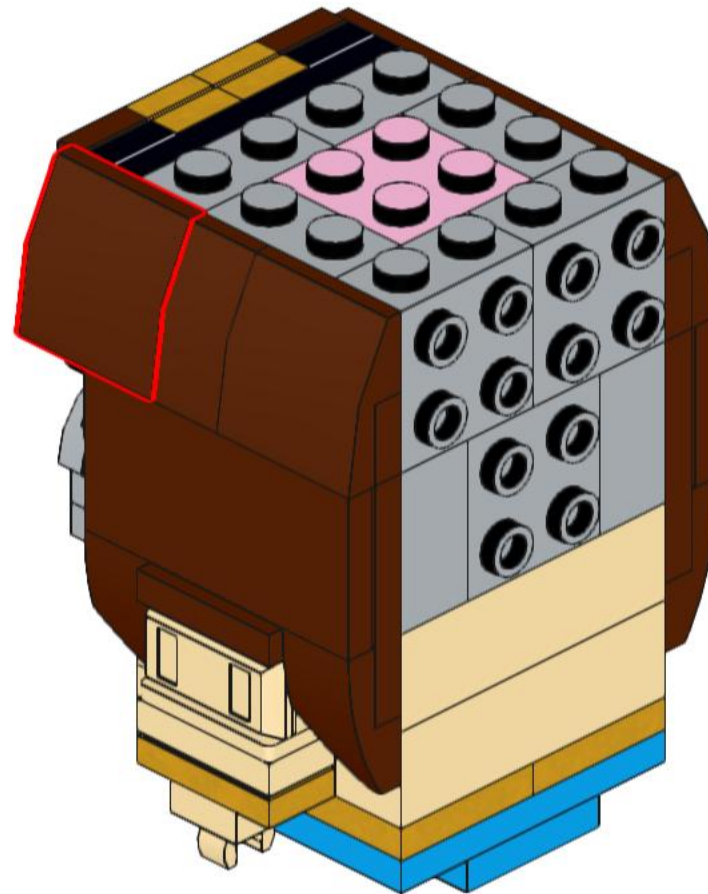
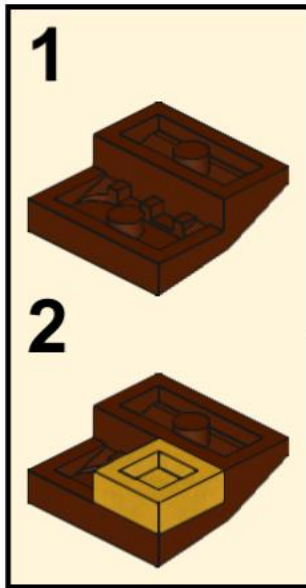
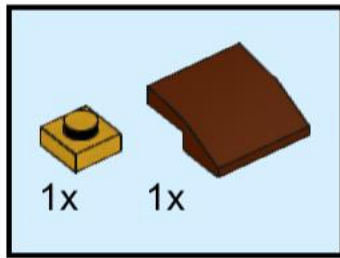

37

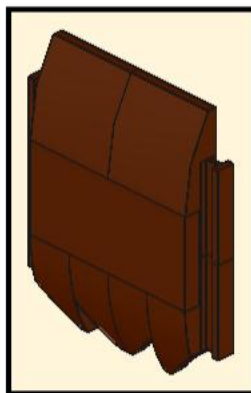
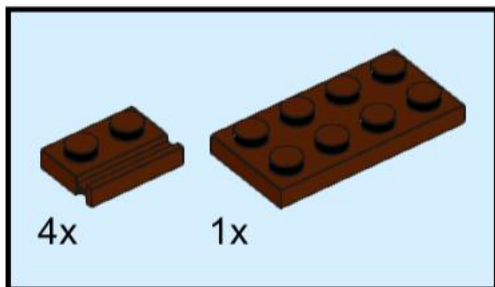

38

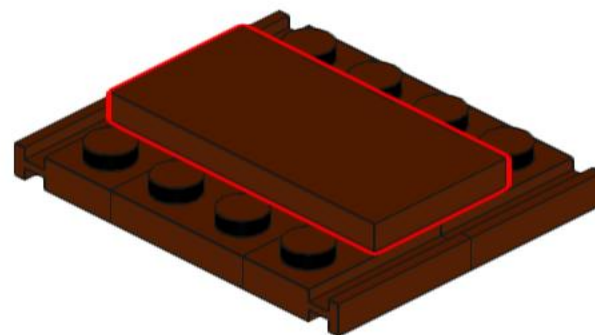
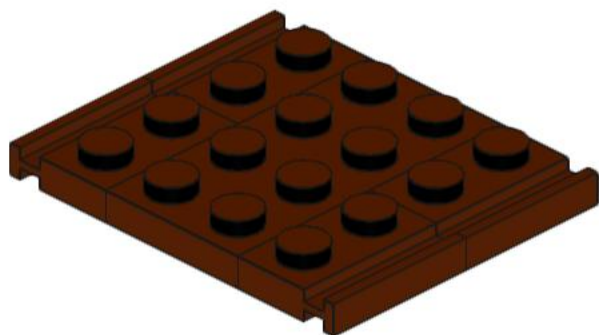
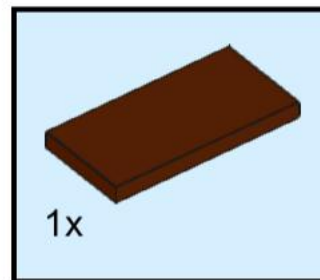

39

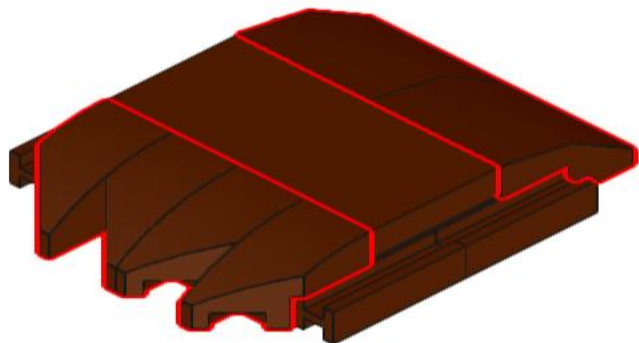
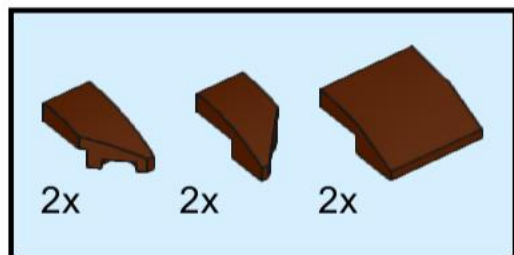

40

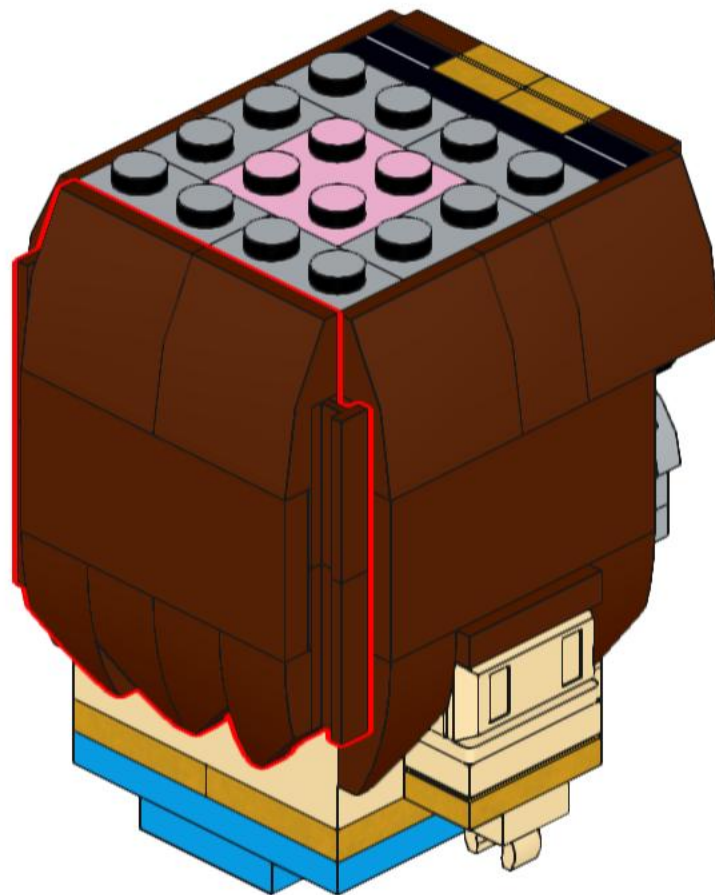

41

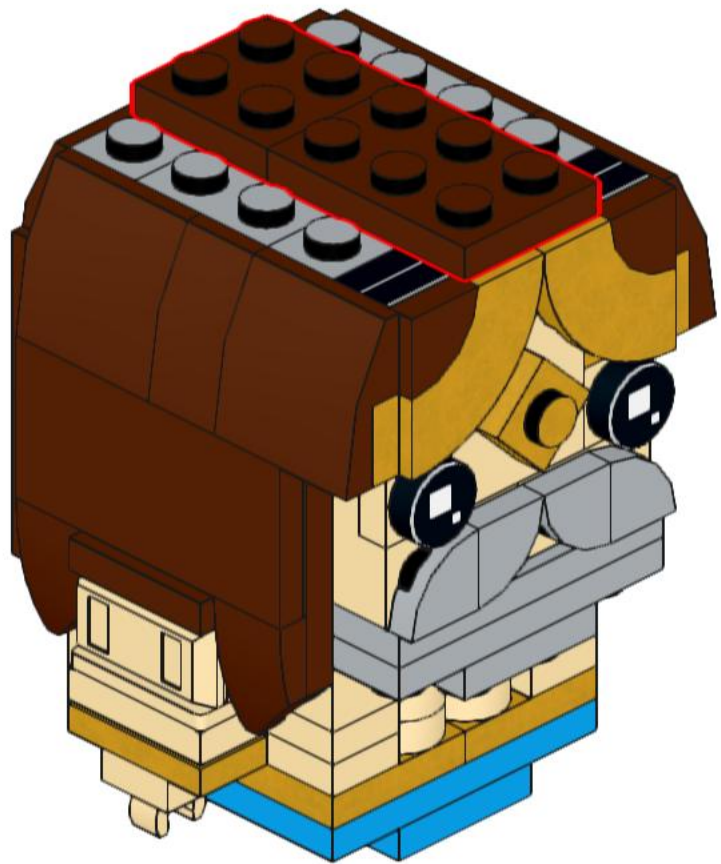
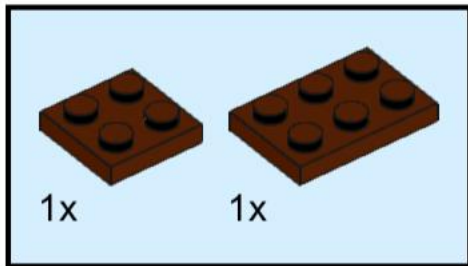

42

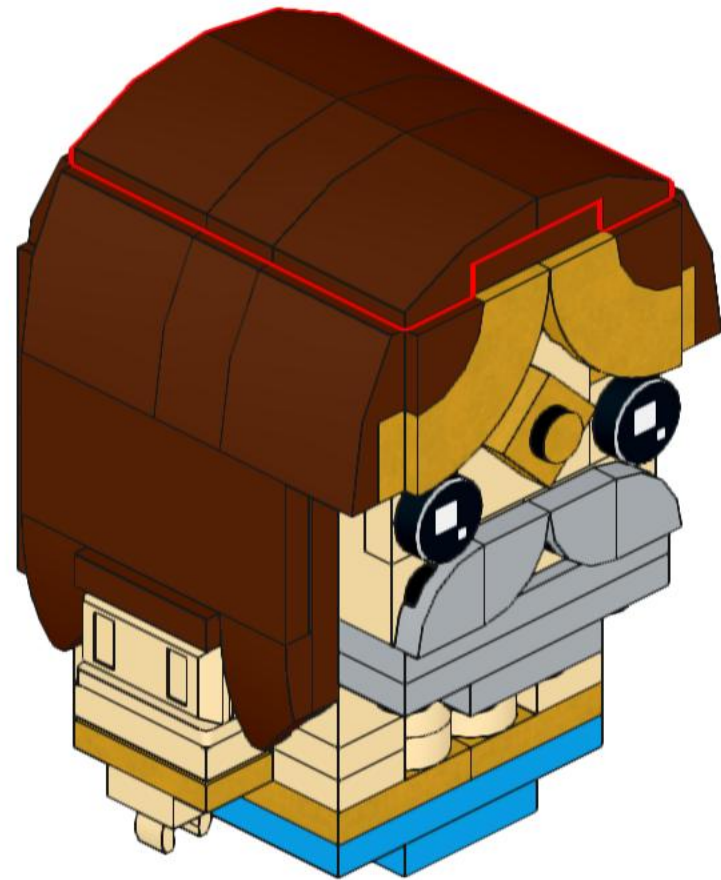
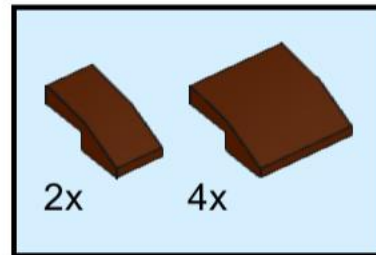

43

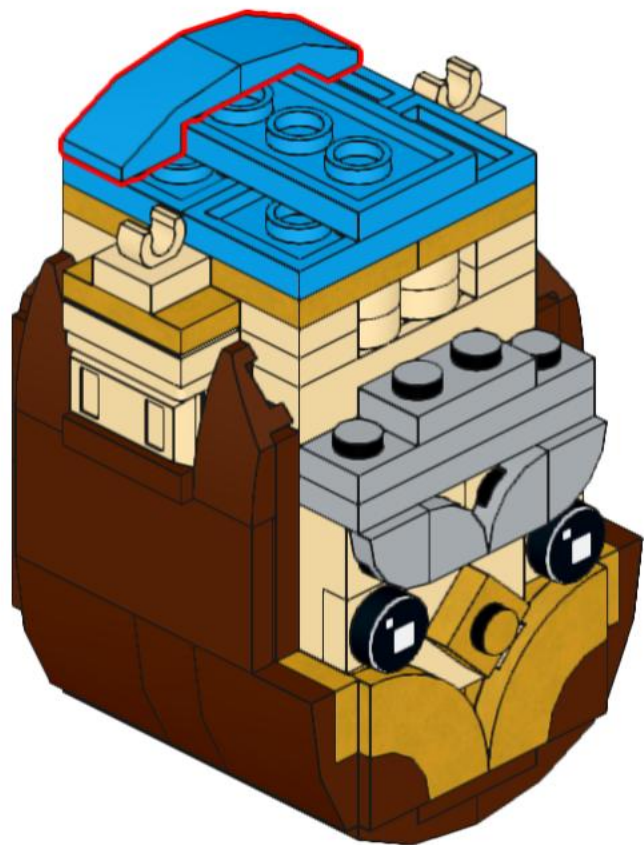
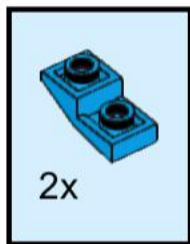

44

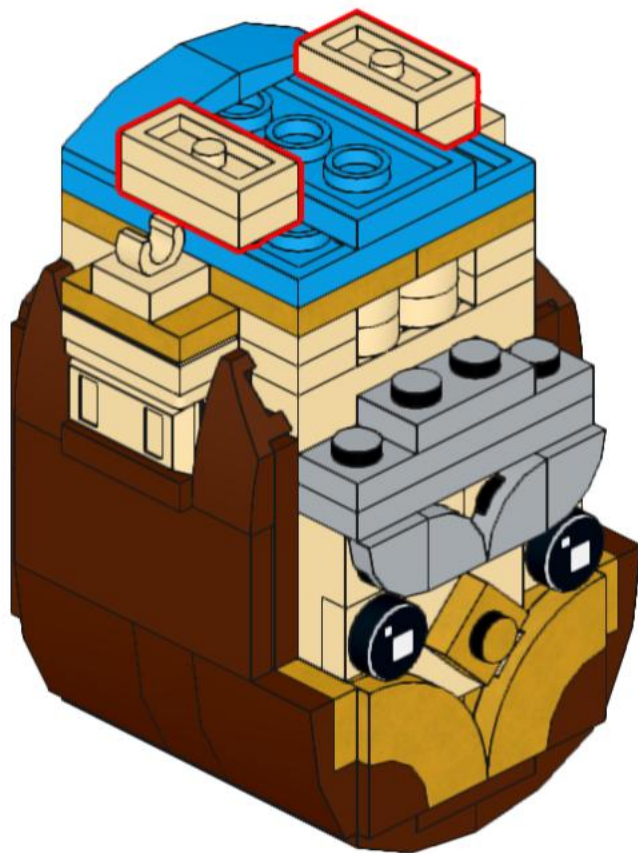
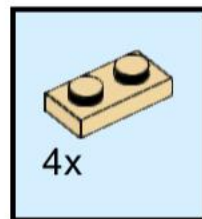

45

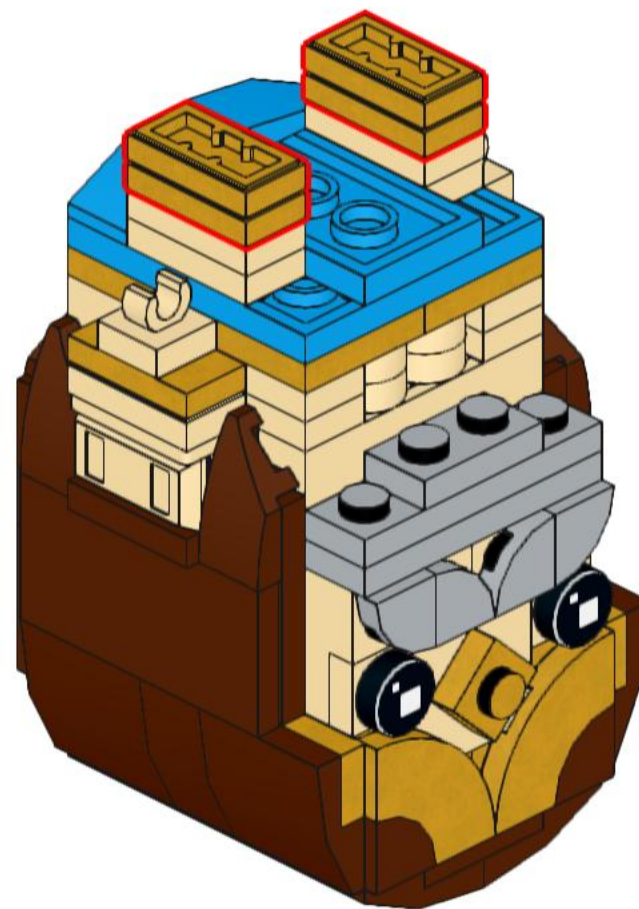
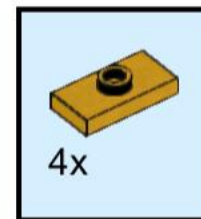

46

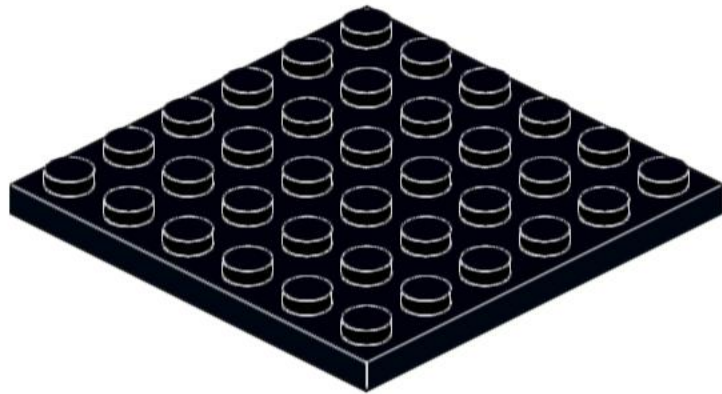
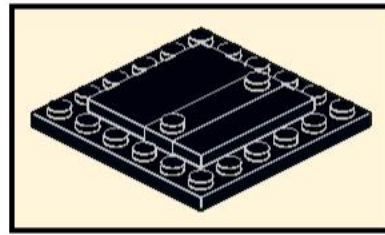
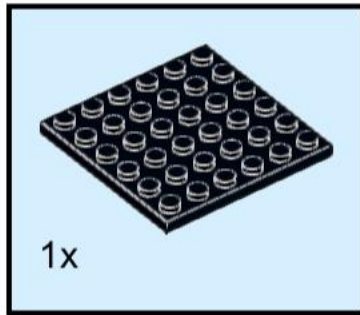

47

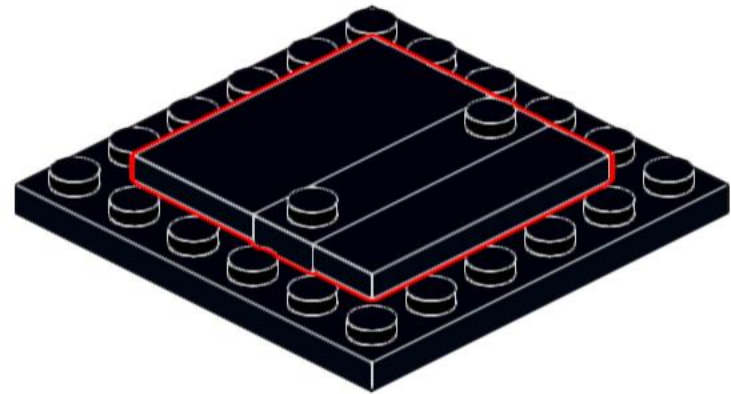
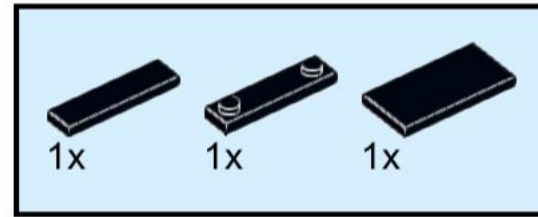

48

