

ADA HEADZ

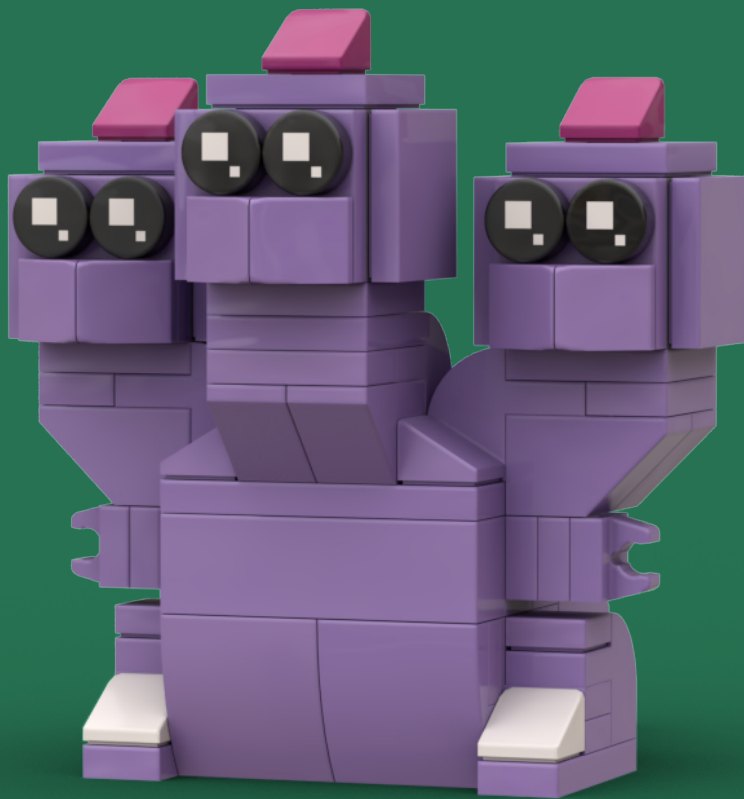

adaheadz.io/manuals

HYDRA



6x



1x



3x



6x



2x



2x



1x



2x



2x



10x

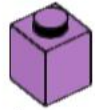

1x



1x



8x

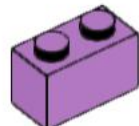

2x

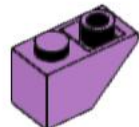

6x



8x

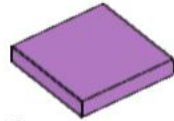

6x



8x



7x



2x

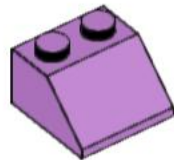

2x

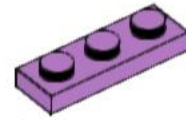

2x



2x

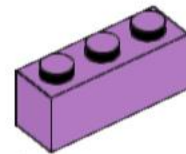

1x

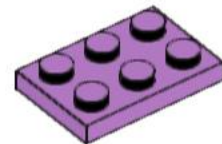

1x

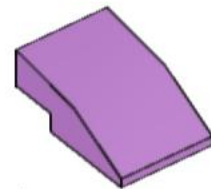

1x

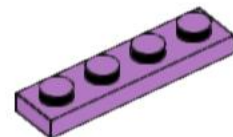

3x

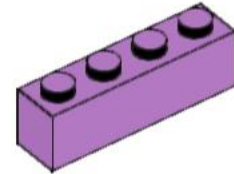

2x

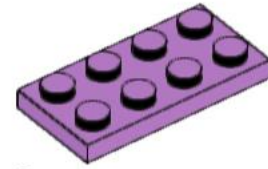

2x

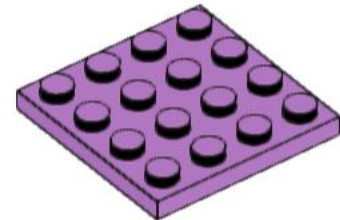

1x



7x

1

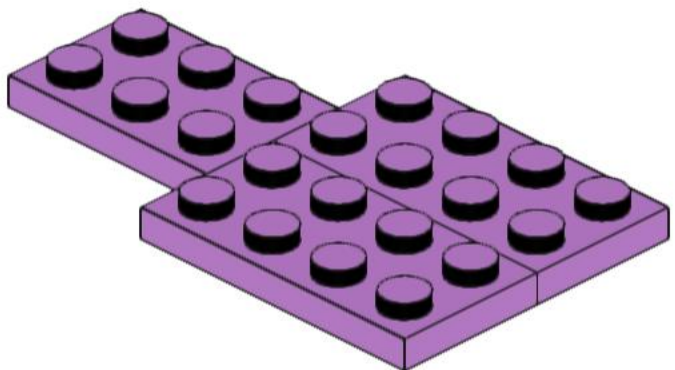
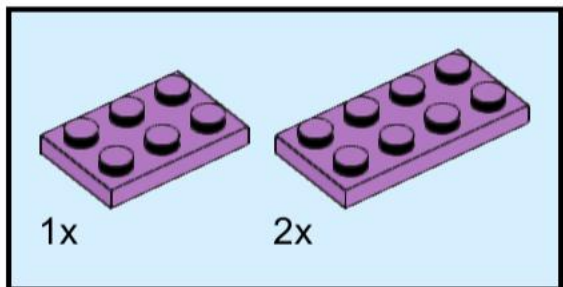

2

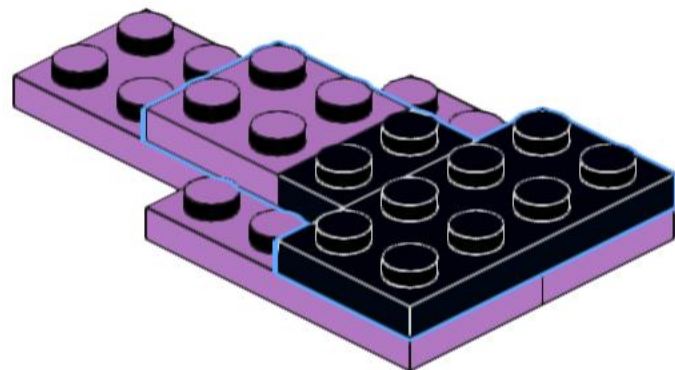
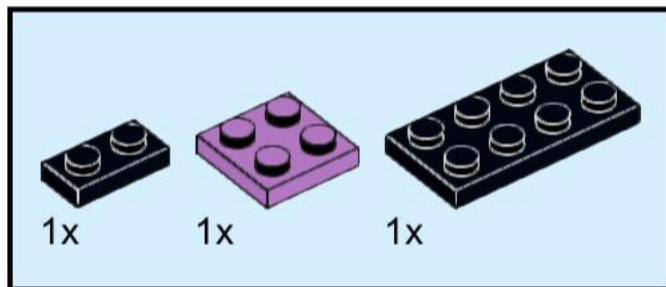

3

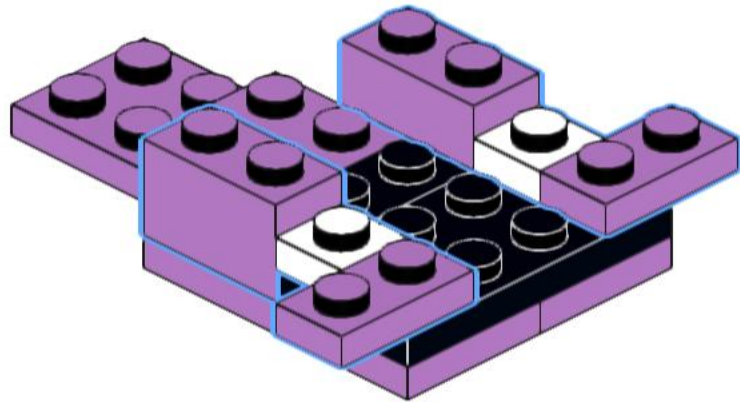
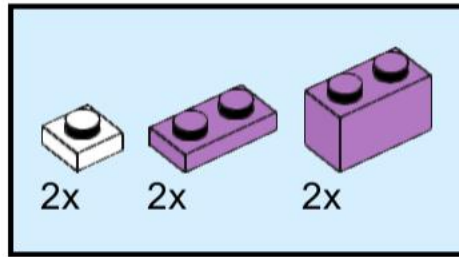

4

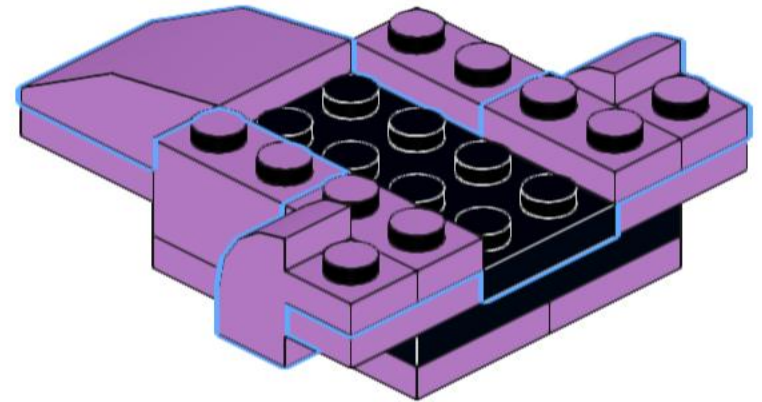
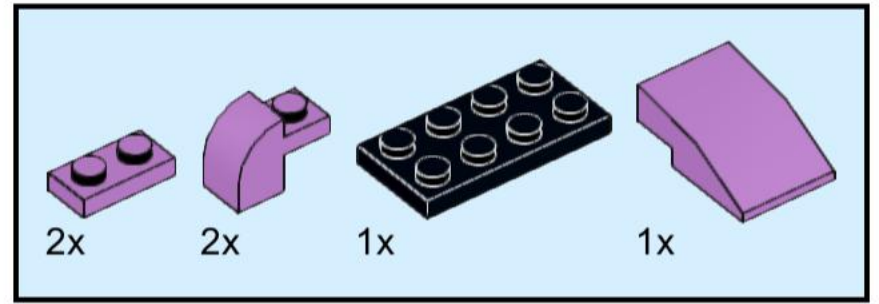

5

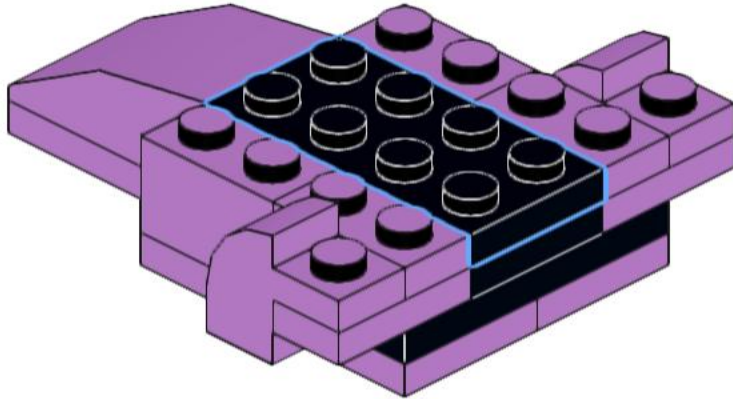
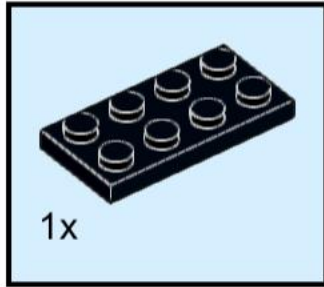

6

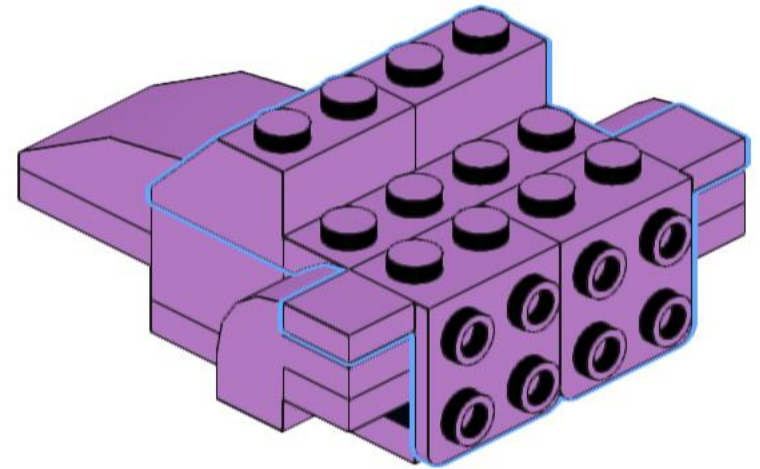
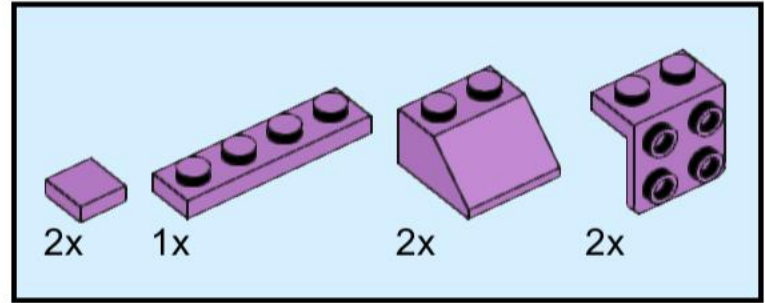

7

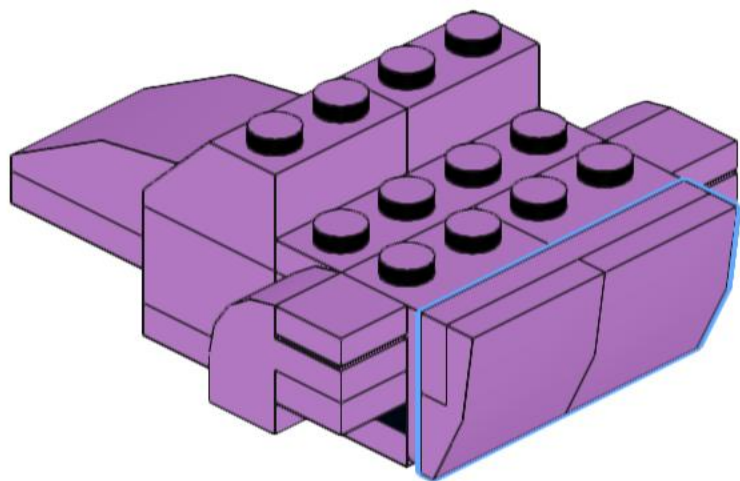
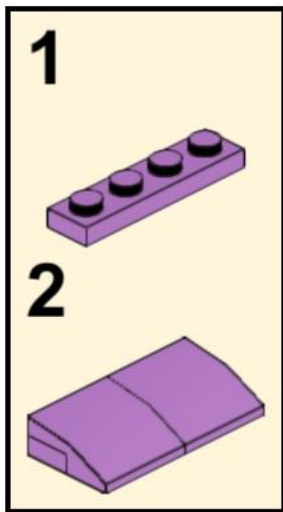
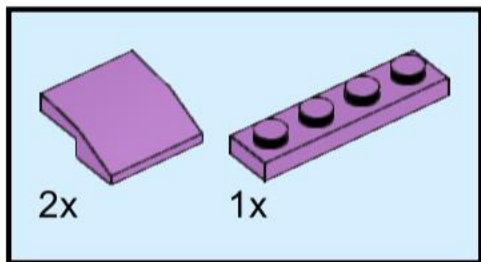

8

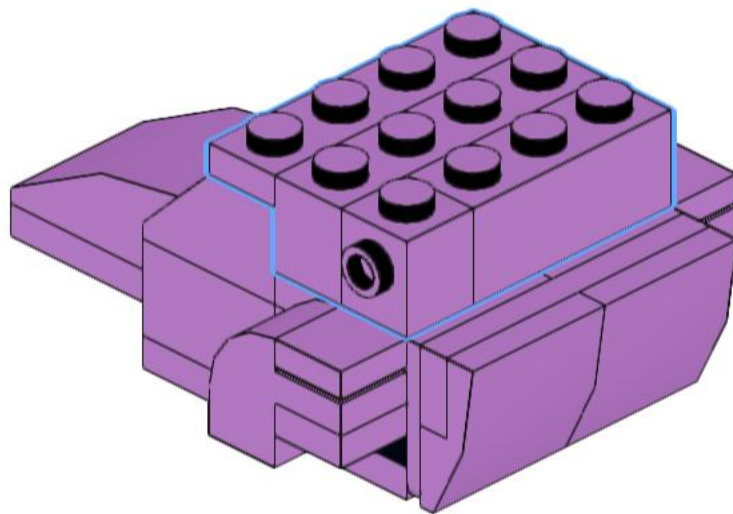
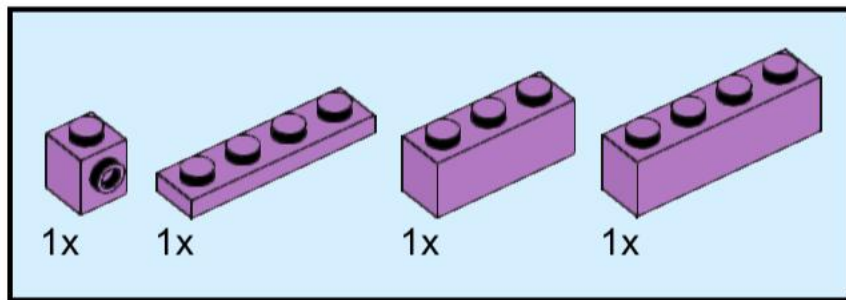

9

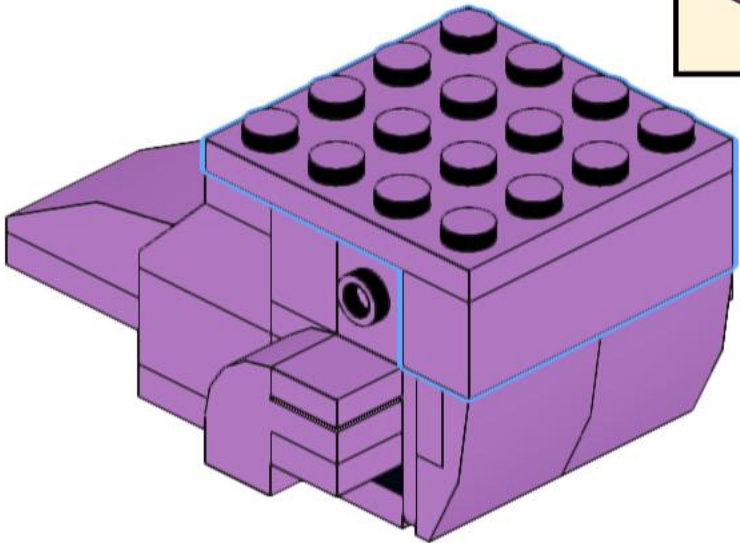
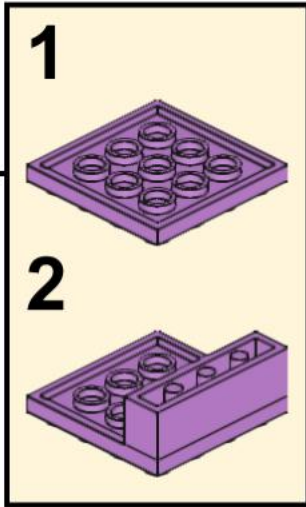
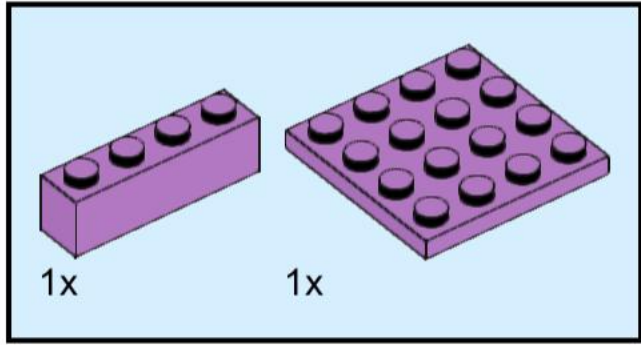

10

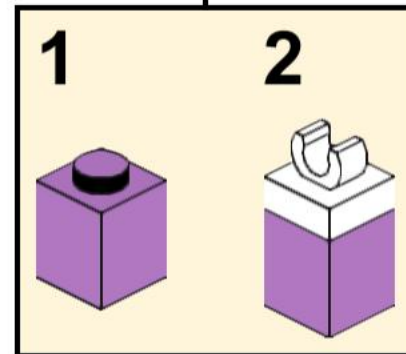
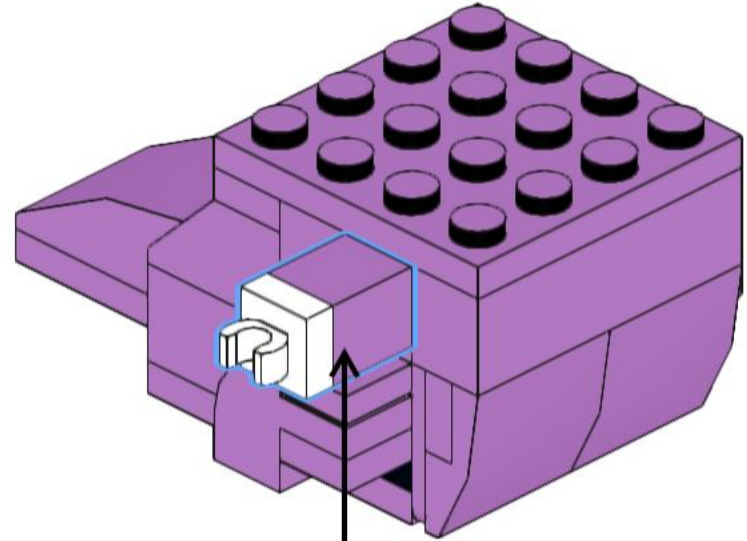
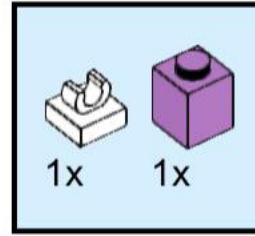

11

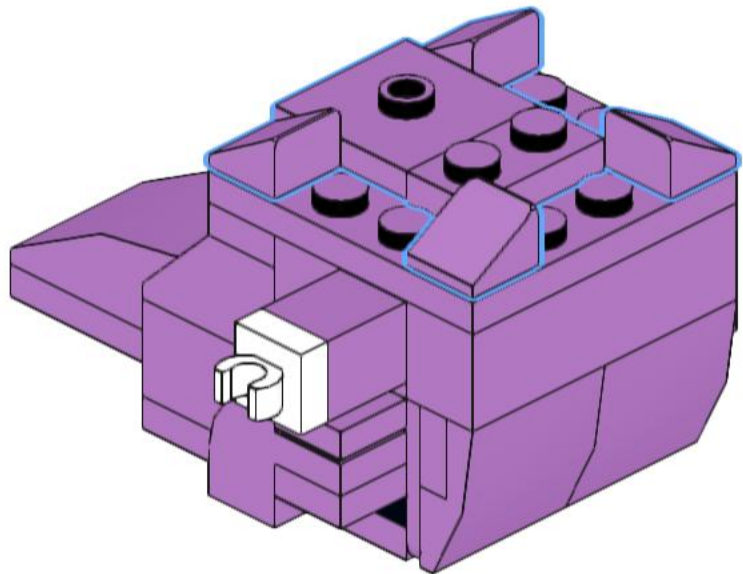
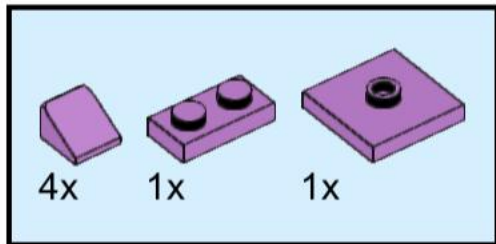

12

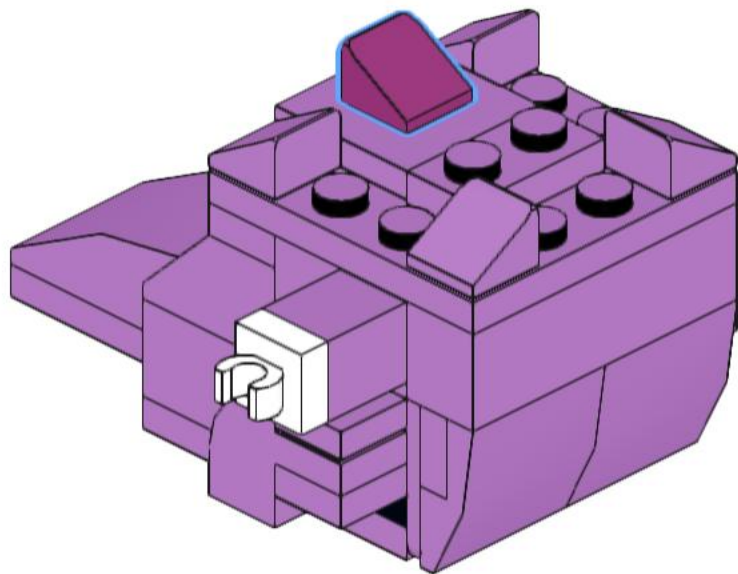
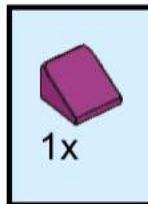

13

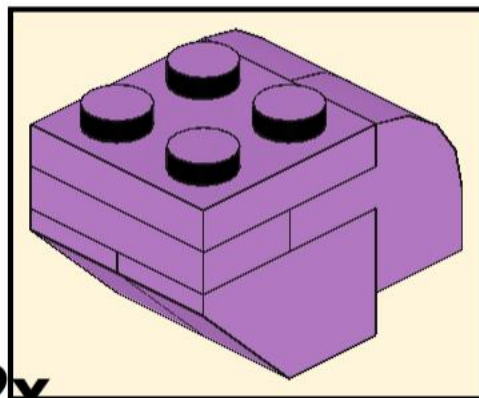
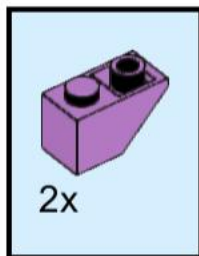

2x



14

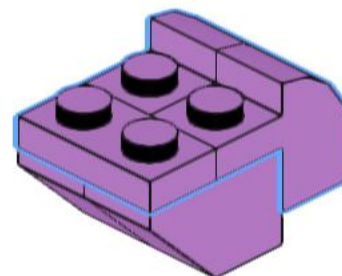
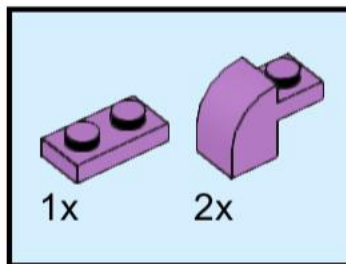

15

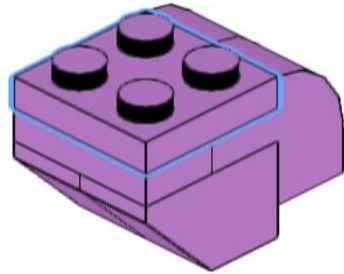
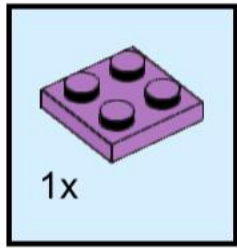

16

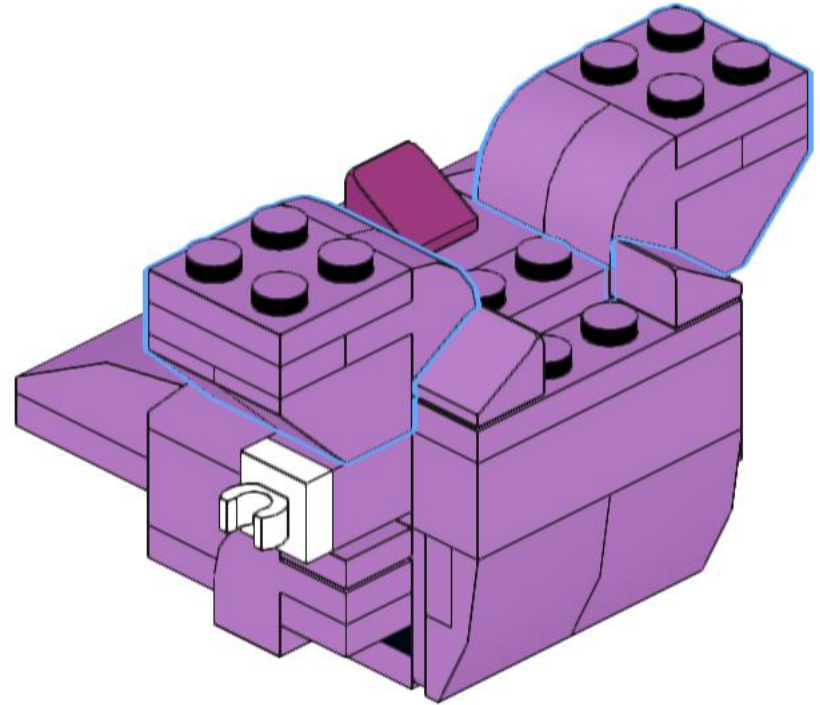

17

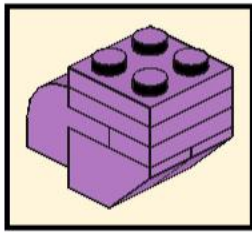
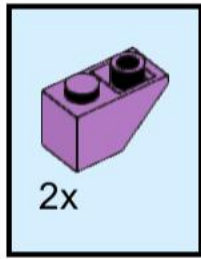

18

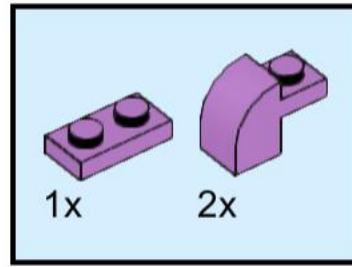

19

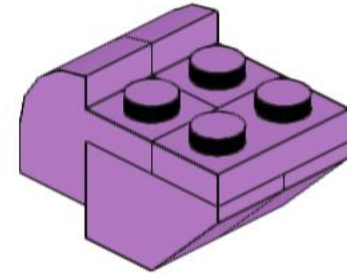
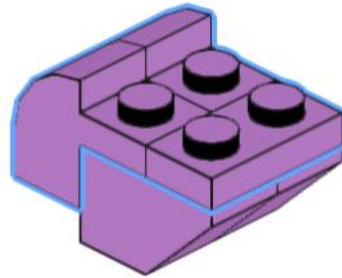
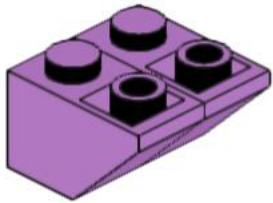

20

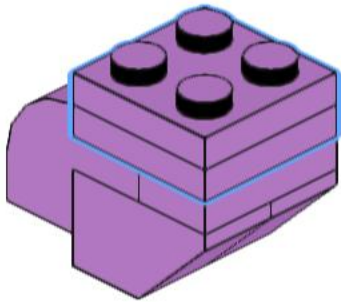
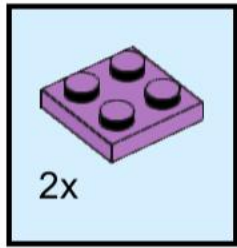

21

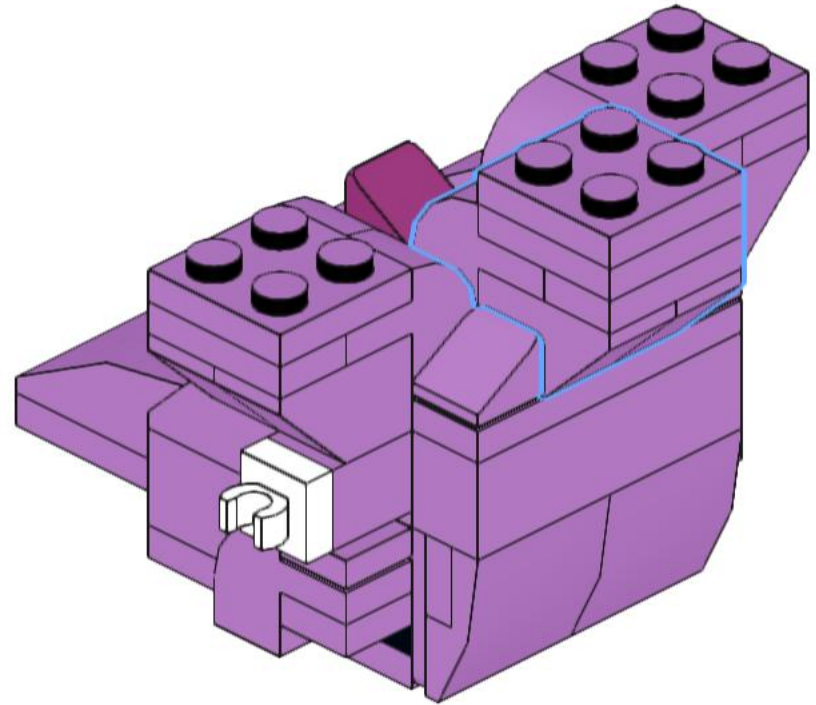

22

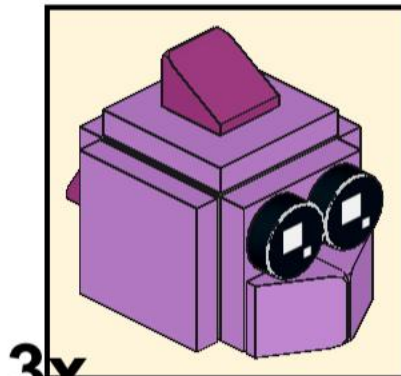
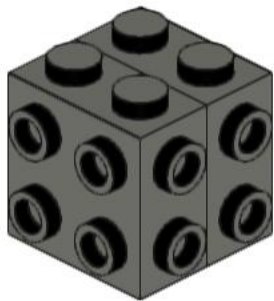
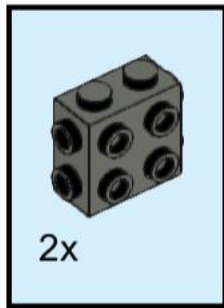

23

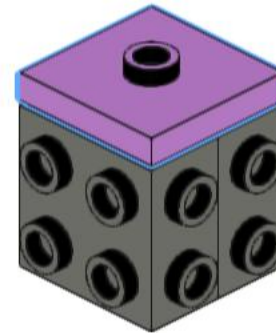
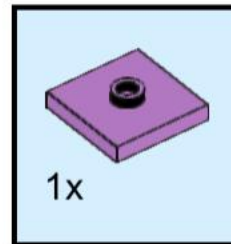

24

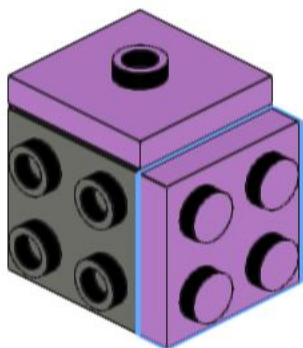
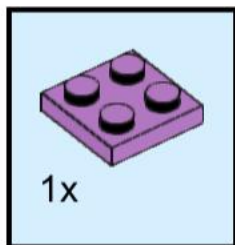

25

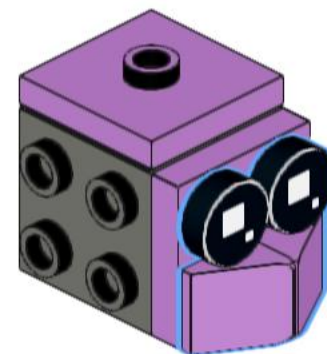
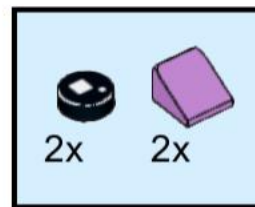

26

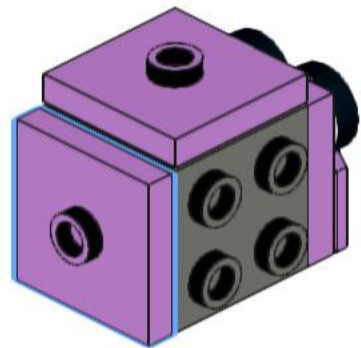
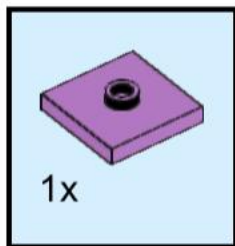

27

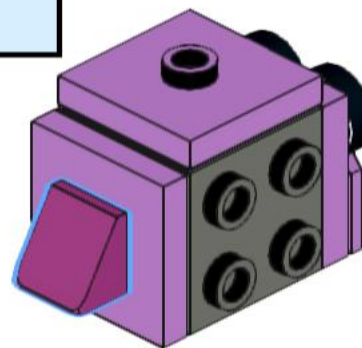
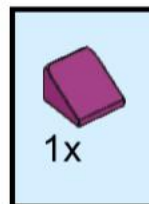

28

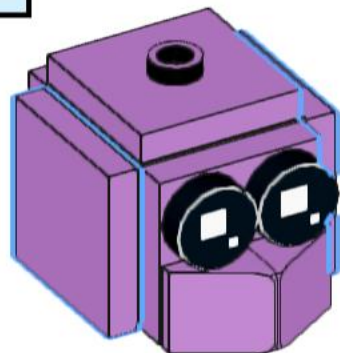
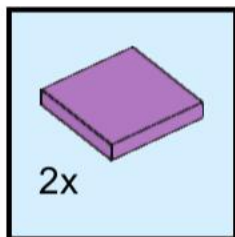

29

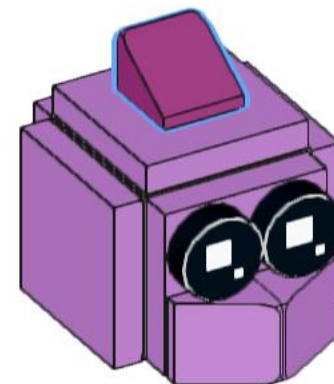
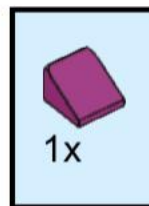

30

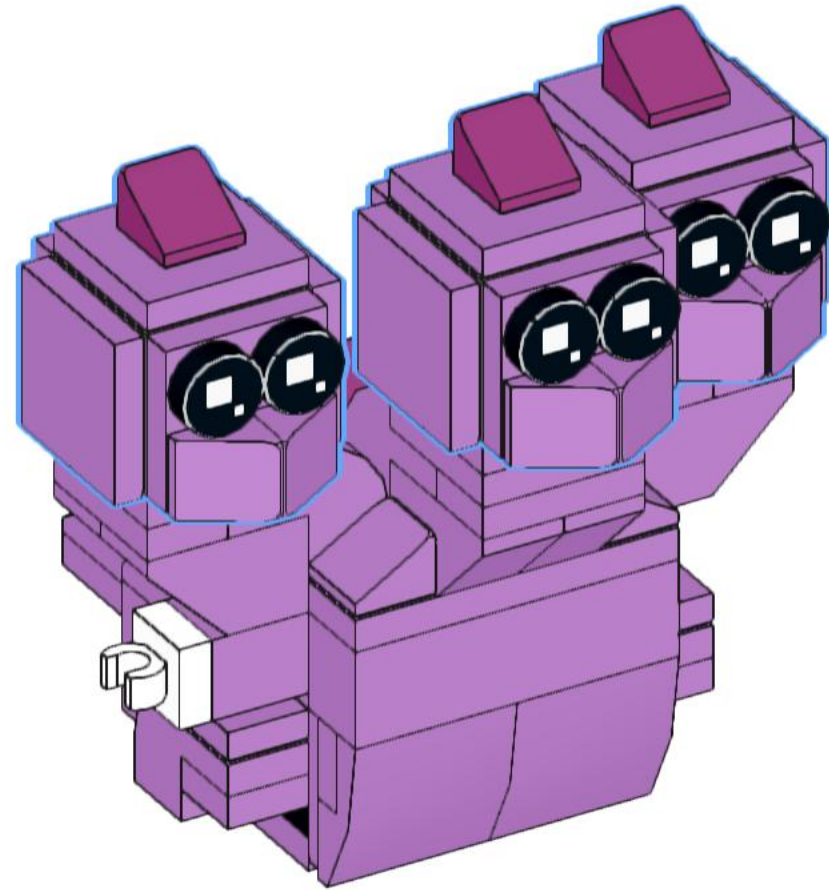

31

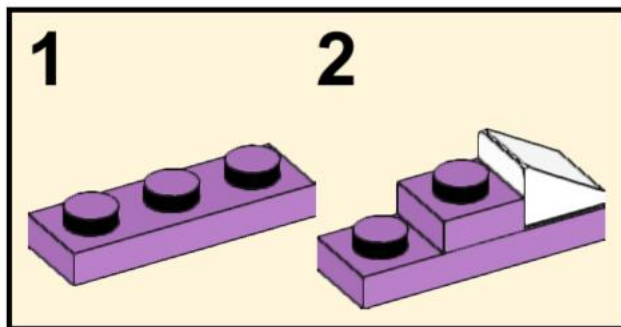
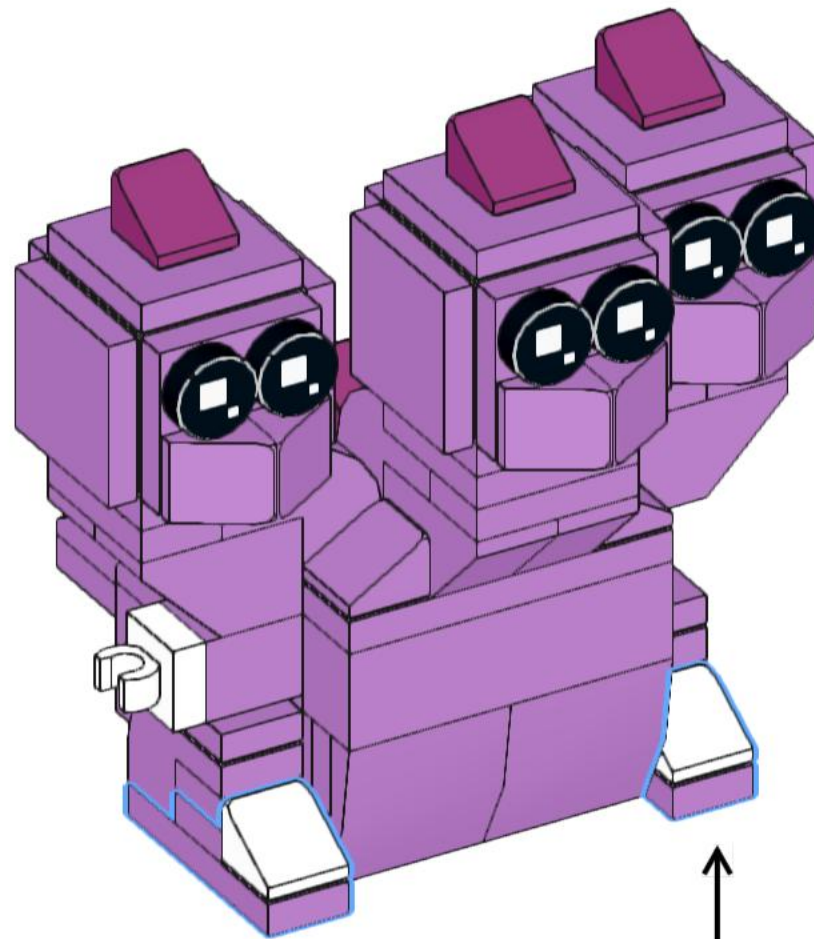
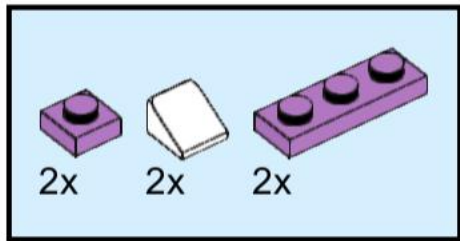

2x