

ADA HEADZ

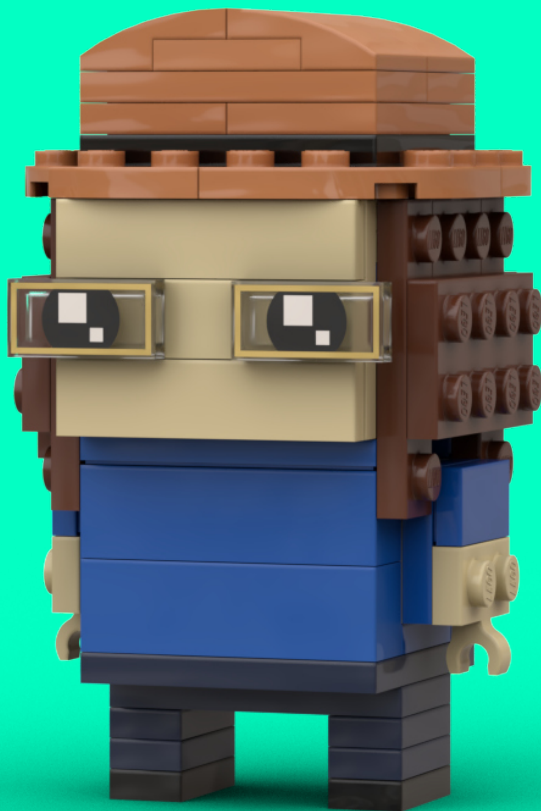

adaheadz.io/manuals

GOERTZEL



2x



4x



1x



1x



2x



1x



1x



1x



2x



4x

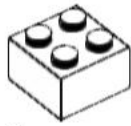

2x



2x



2x

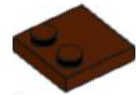

2x



1x

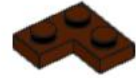

4x



2x



6x



3x



4x



4x

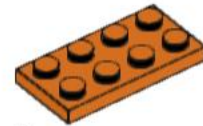

5x



2x

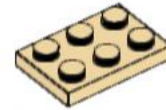

2x

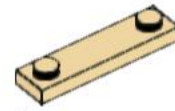

1x

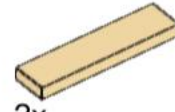

2x

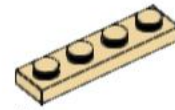

4x



4x



1x



1x

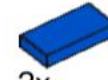

2x

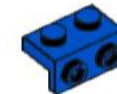

4x

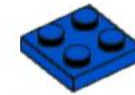

2x



2x

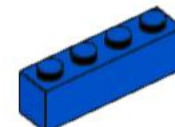

4x

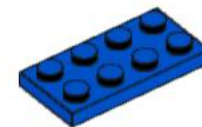

1x



2x

1

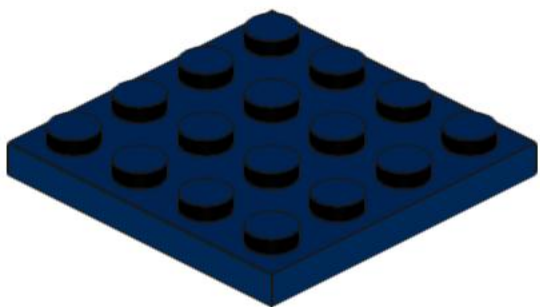
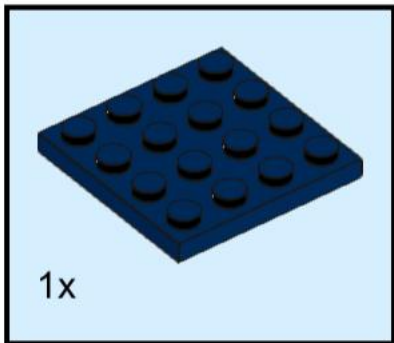

2

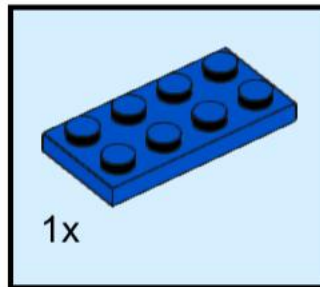

3

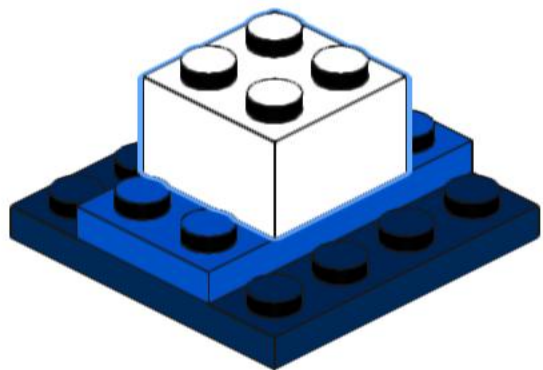
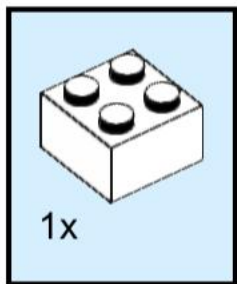

4

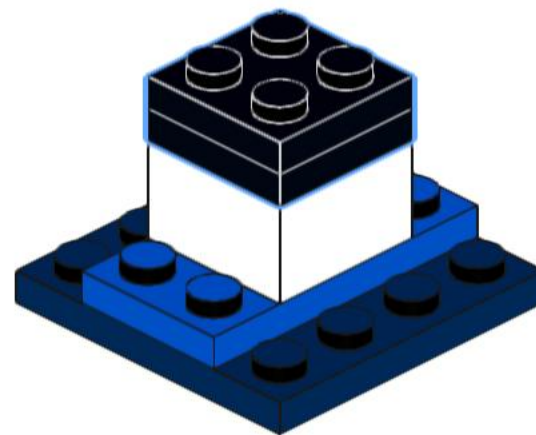
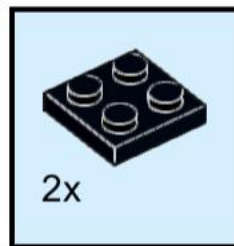

5

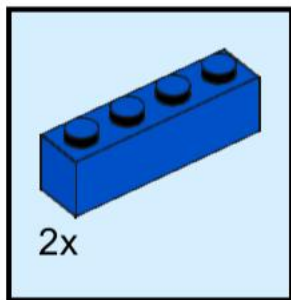

6

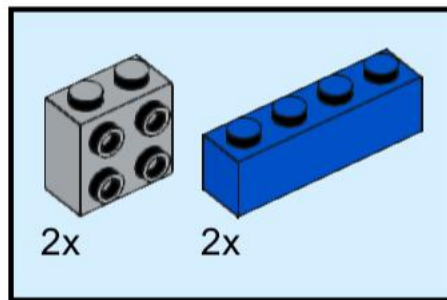

7

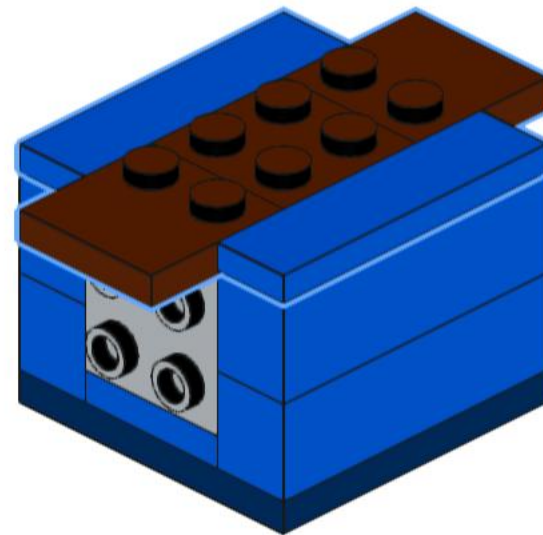
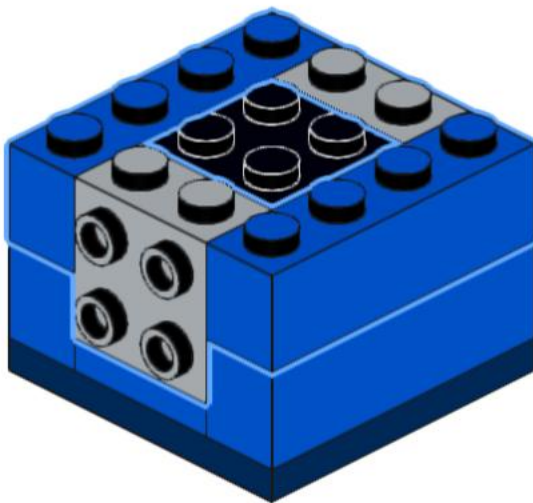
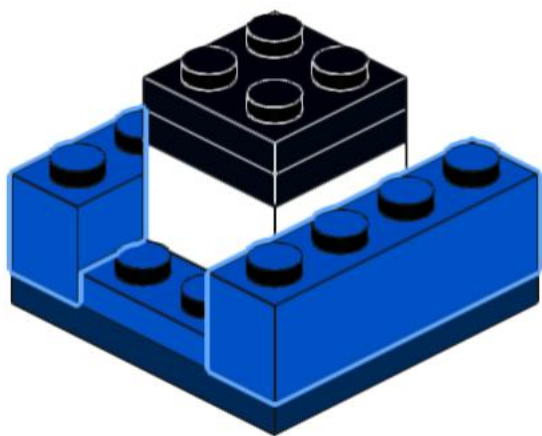
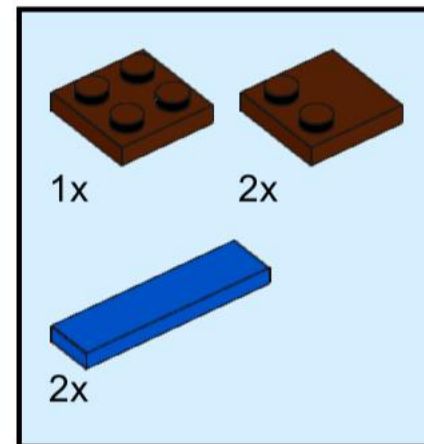

8

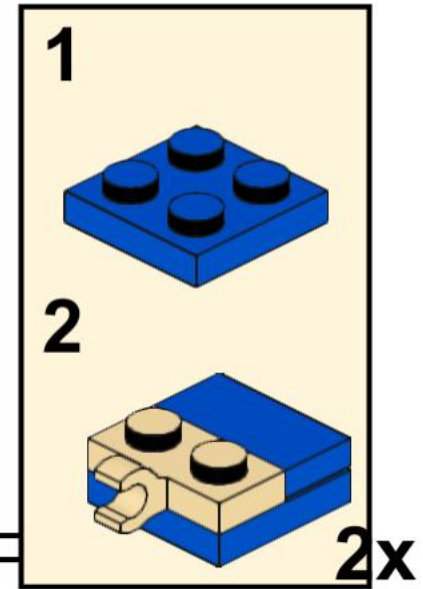
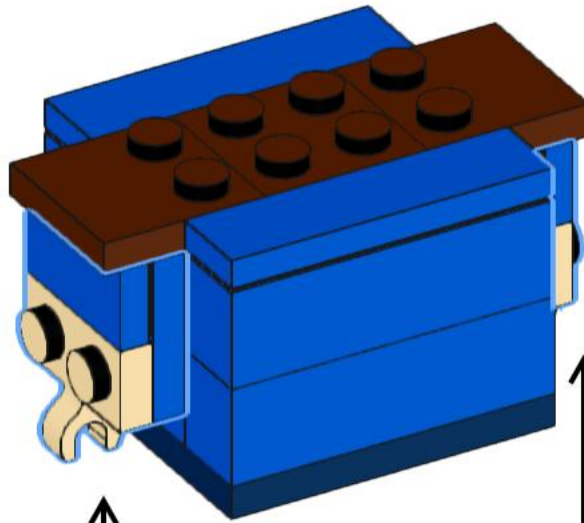
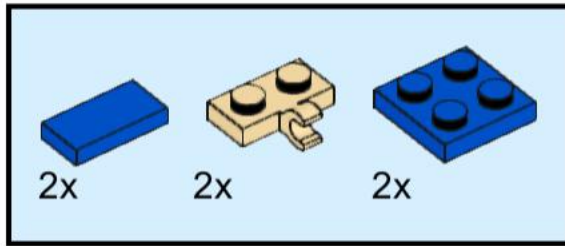

9

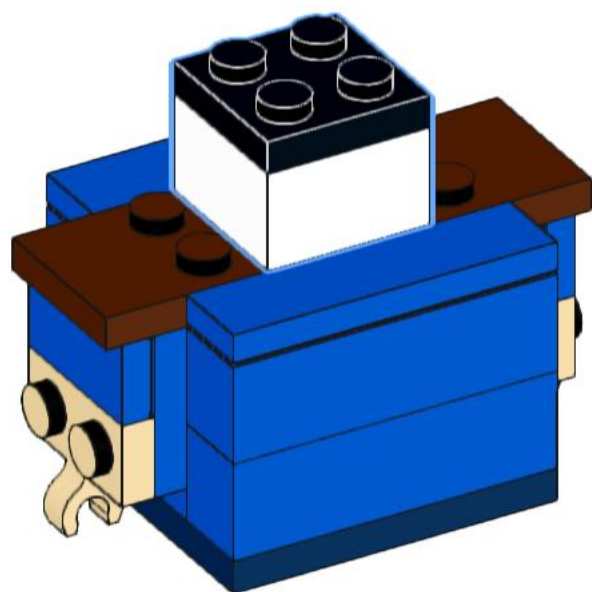
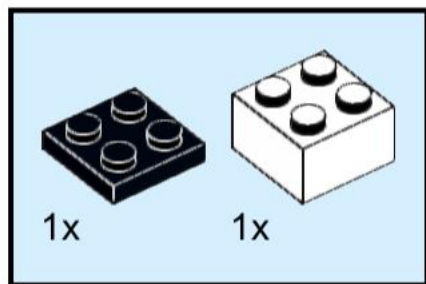

10

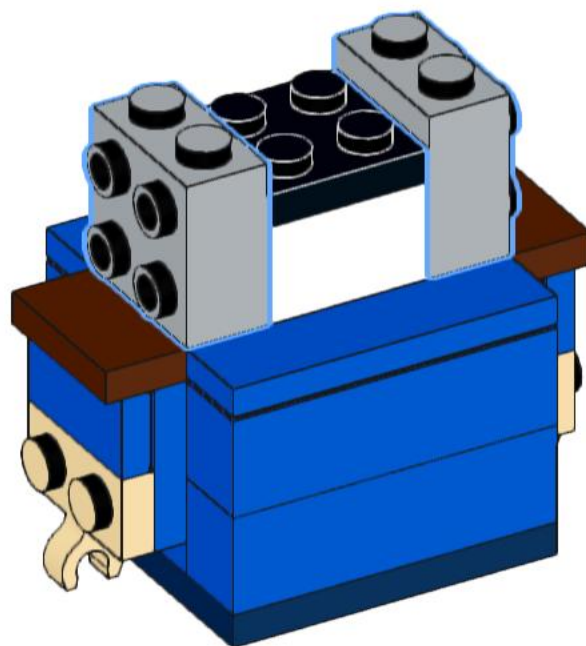
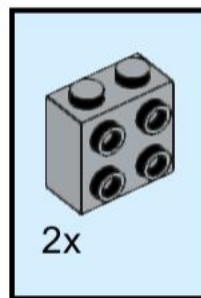

11

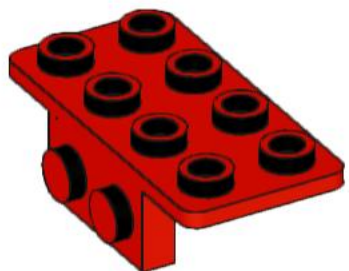
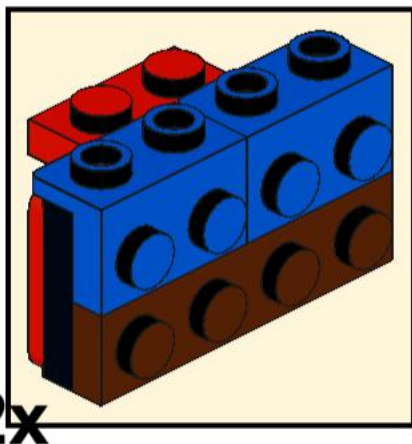
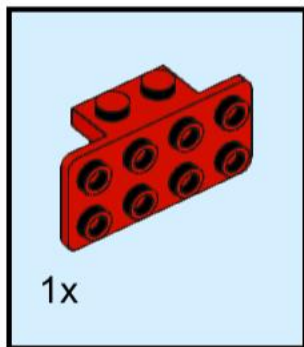

12

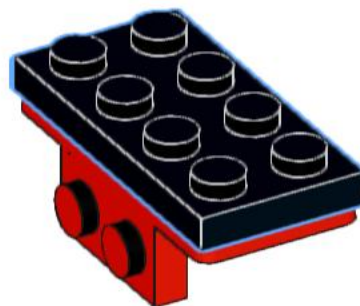
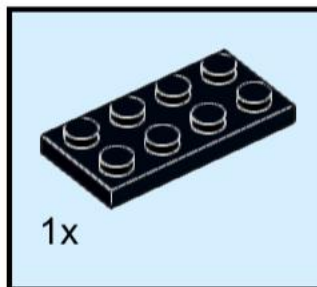

13

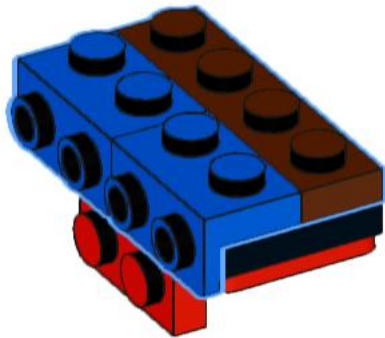
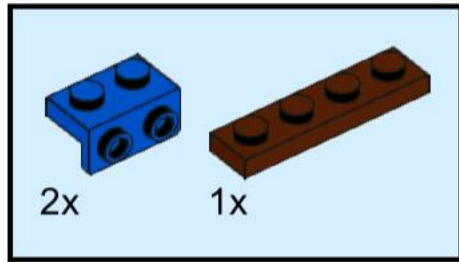

14

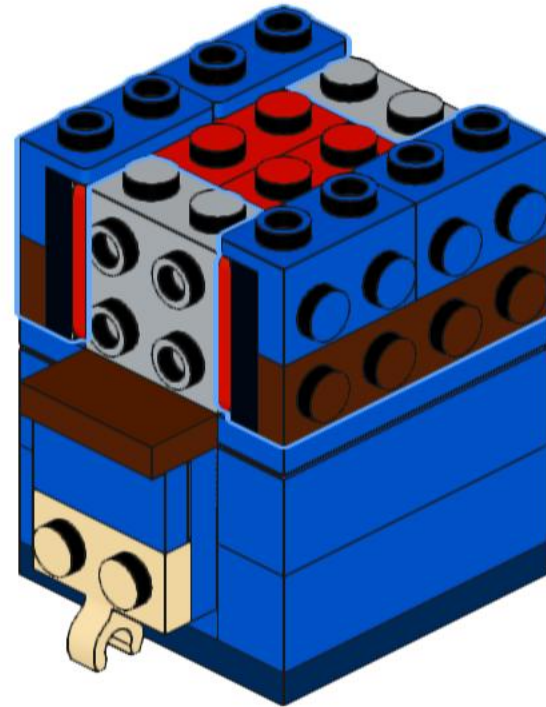

15

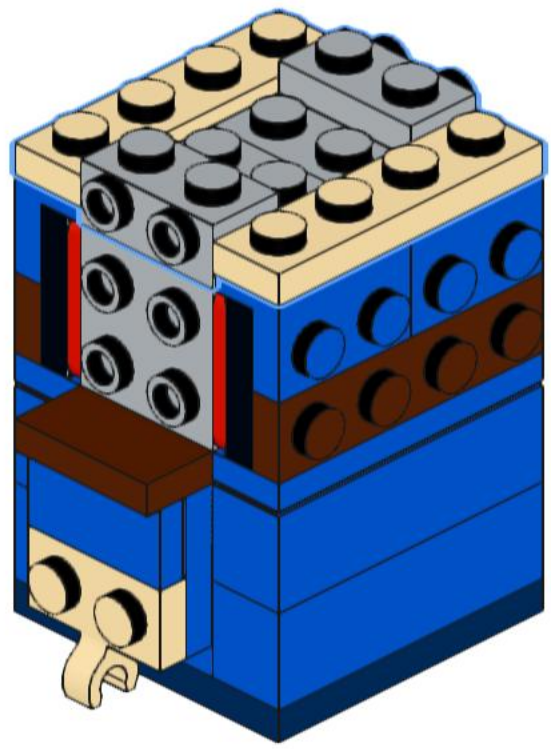
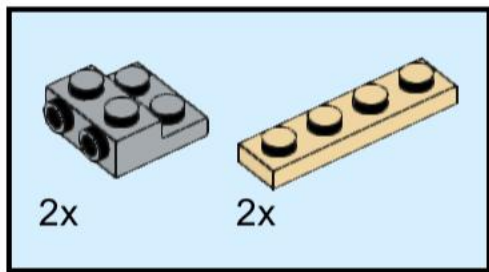

16

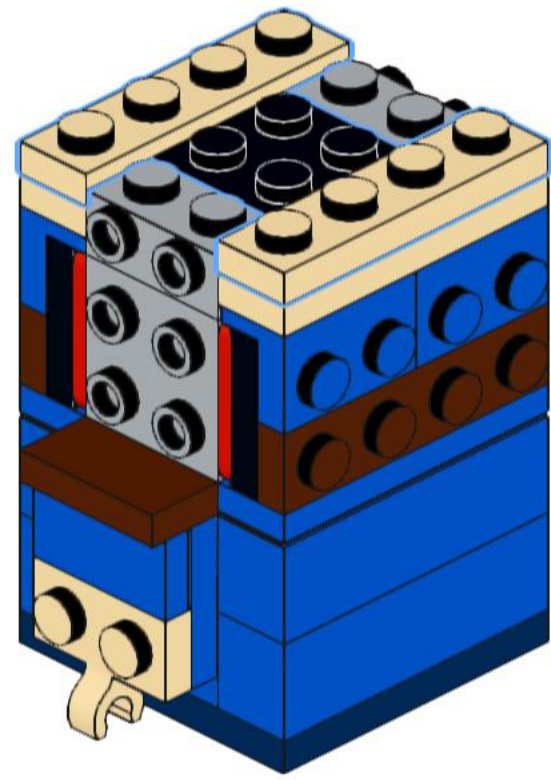
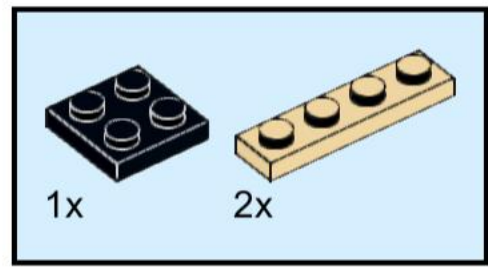

17

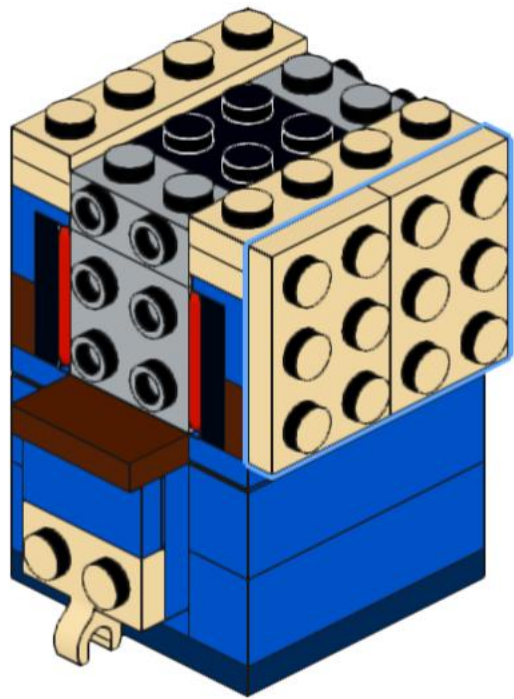
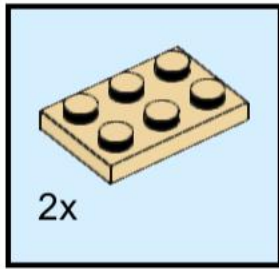

18

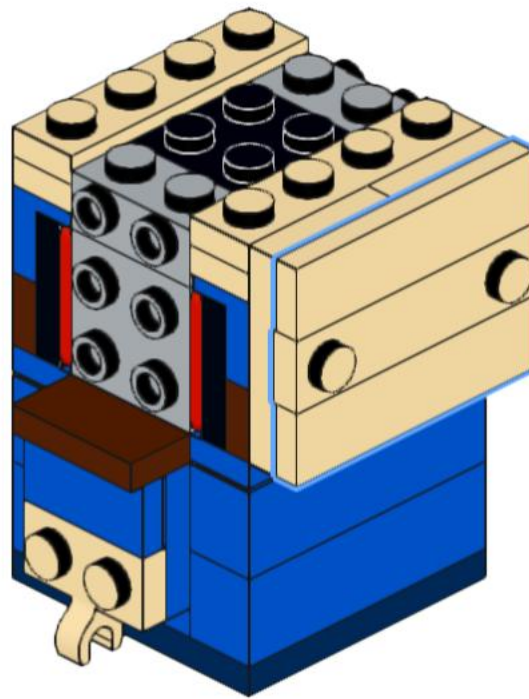
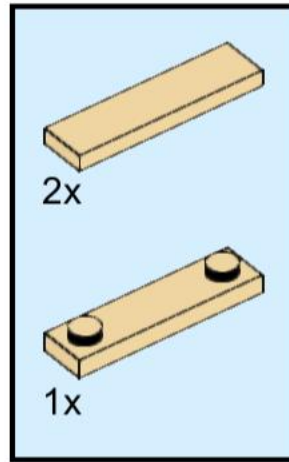

19

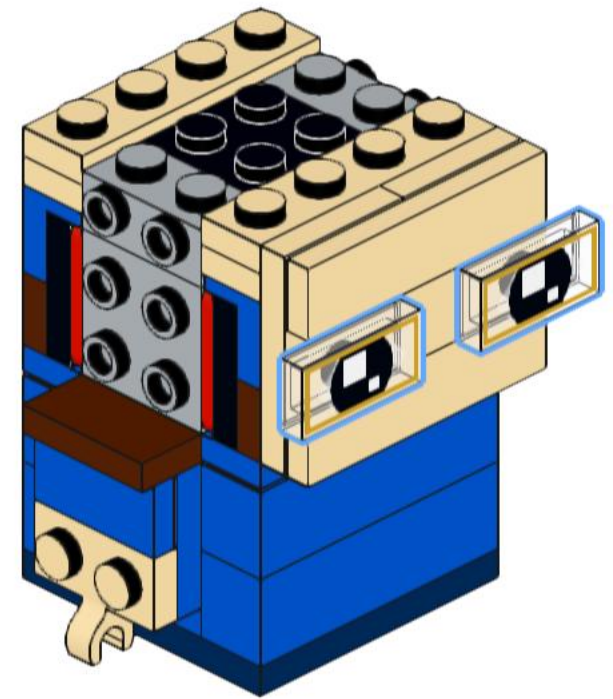
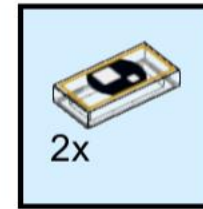

20

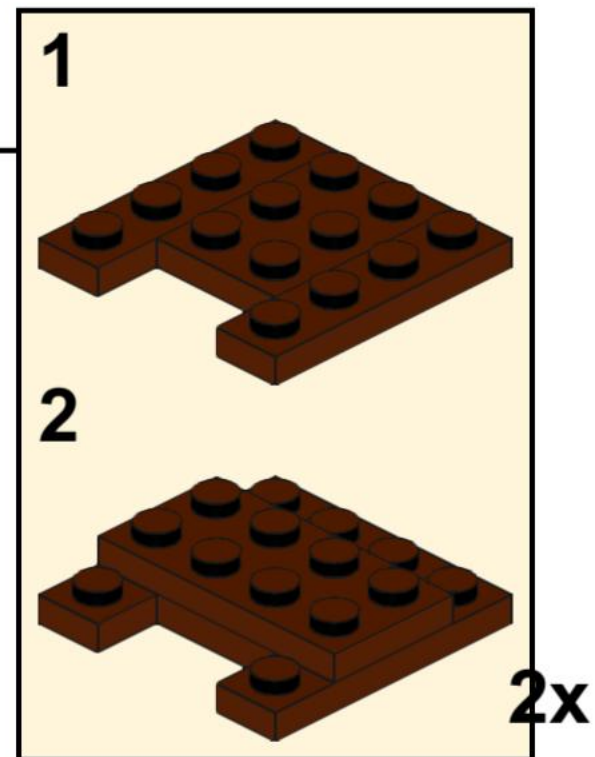
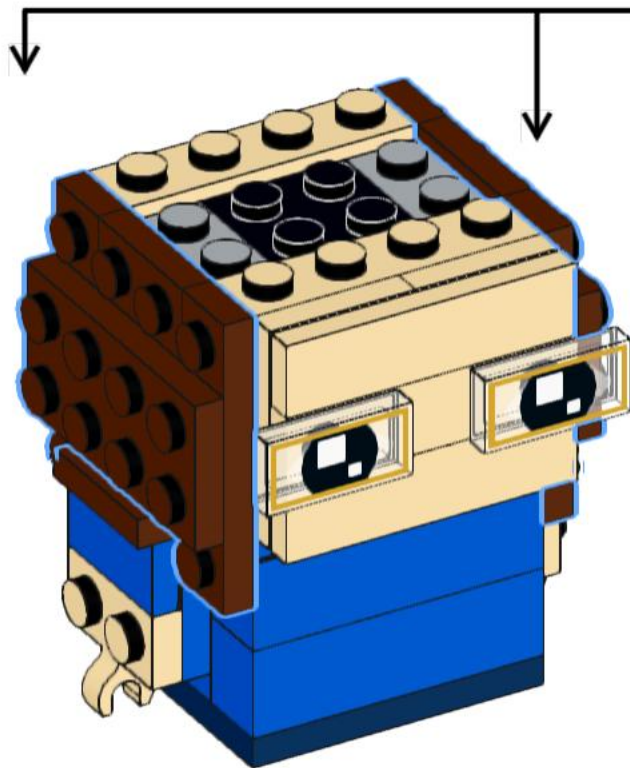
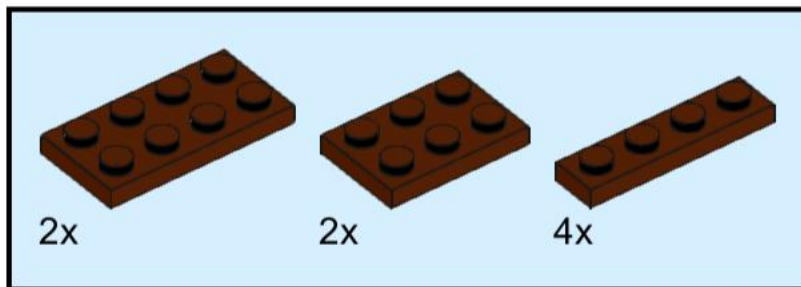

21

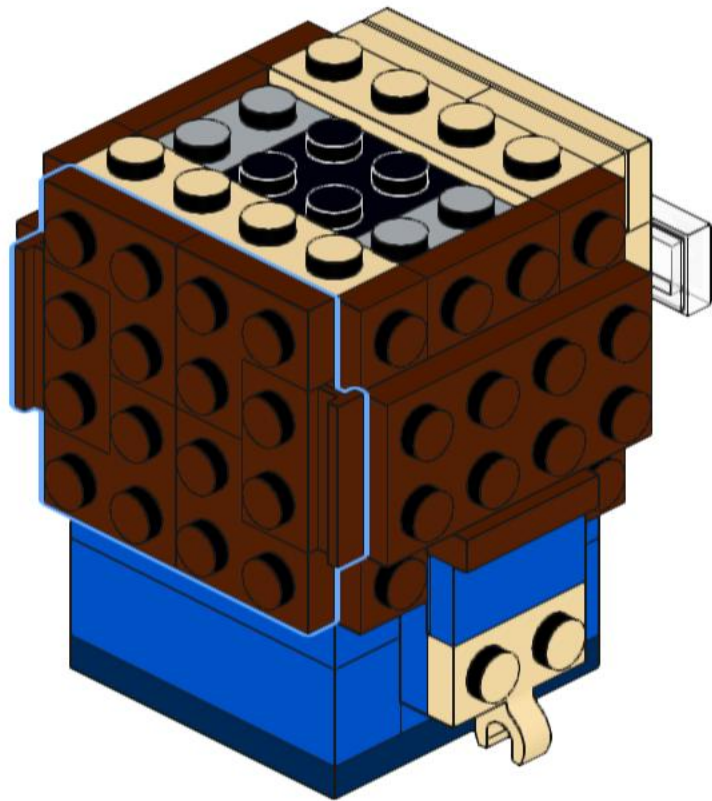
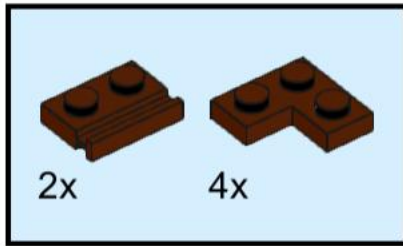

22

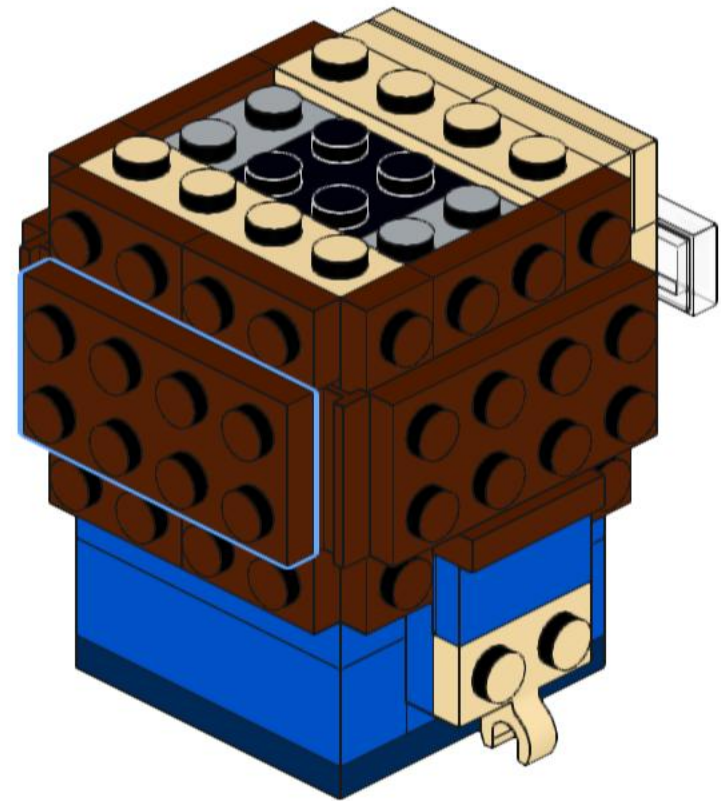
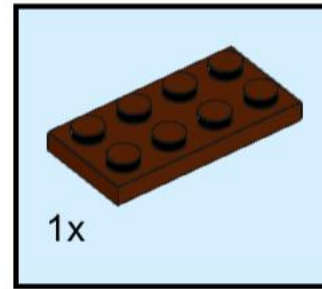

23

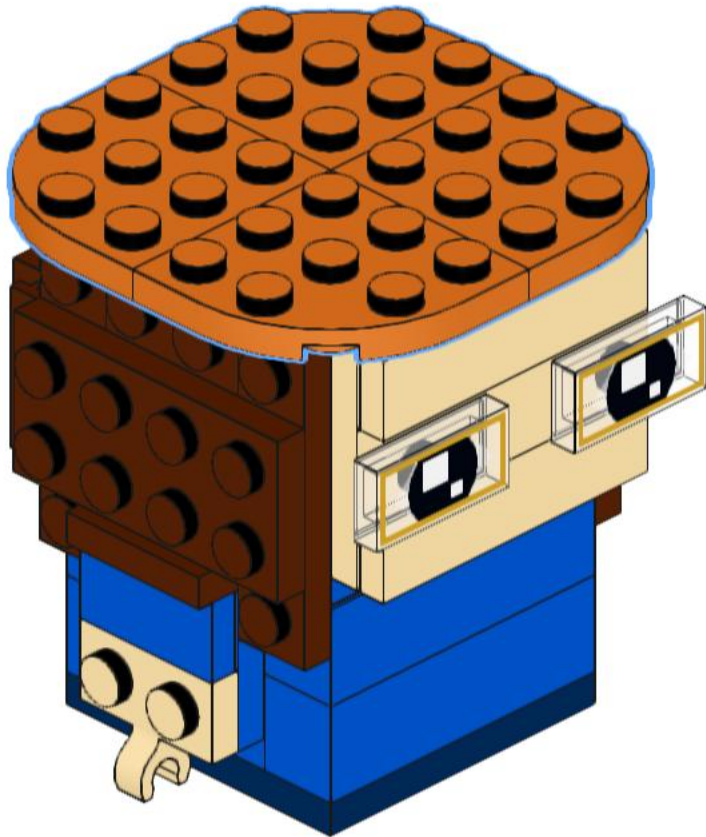
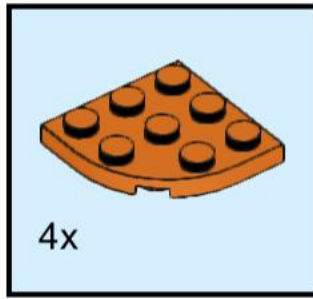

24

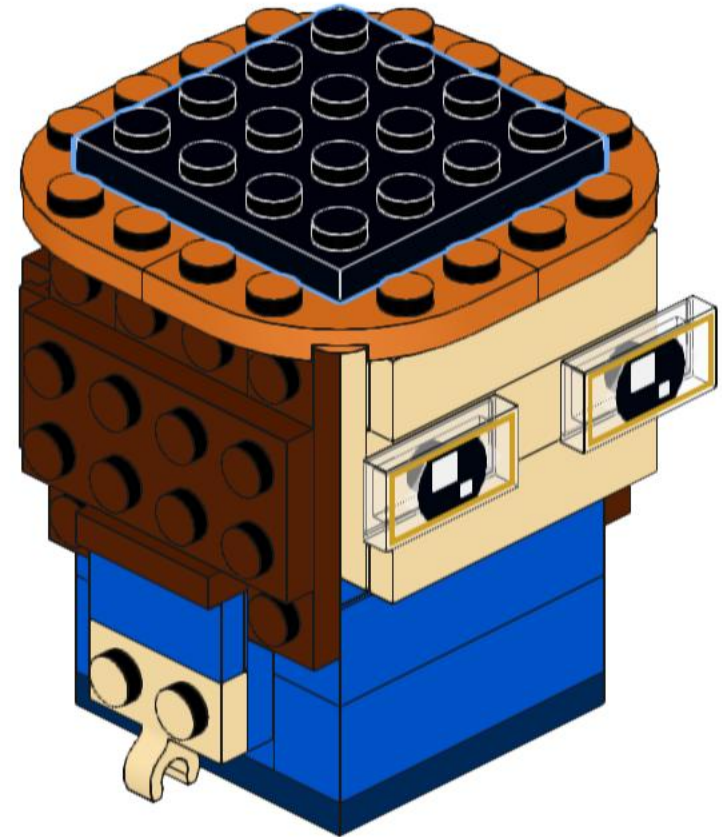
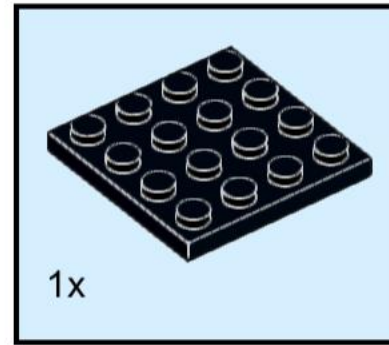

25

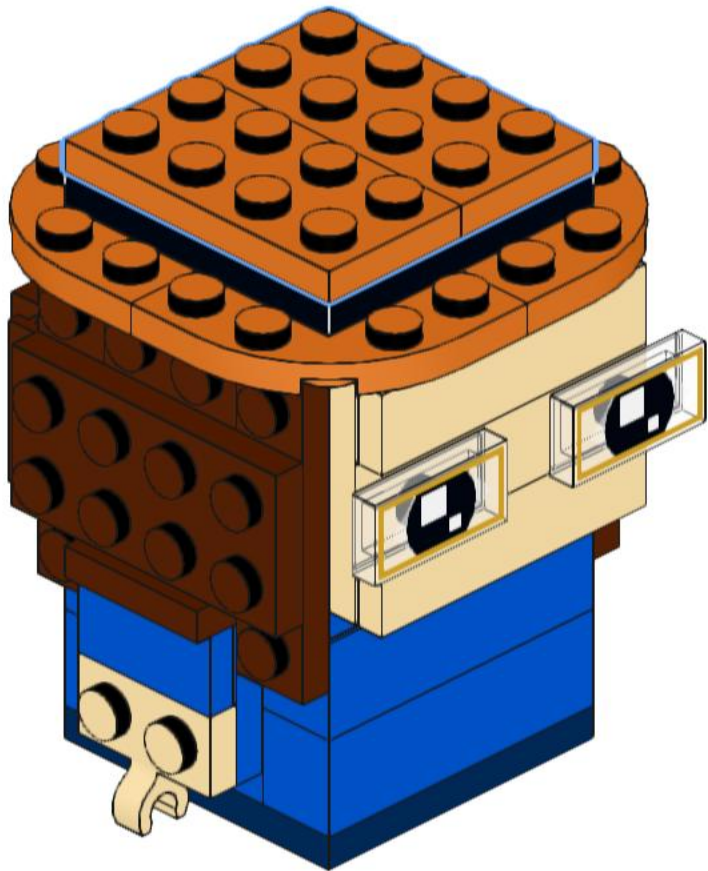
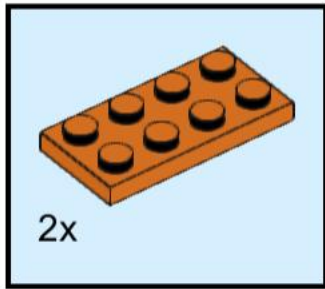

26

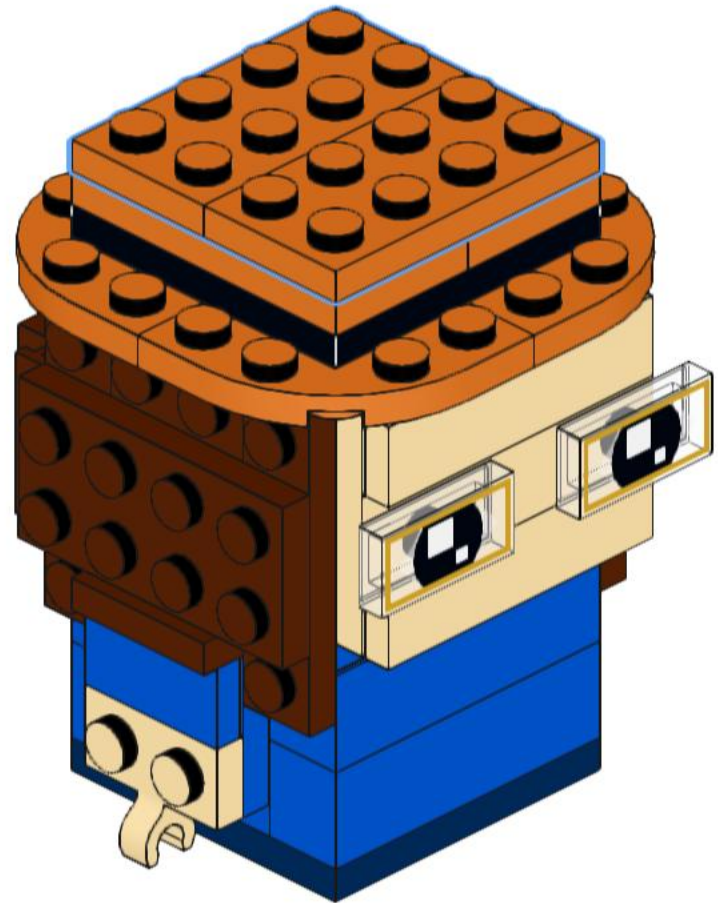
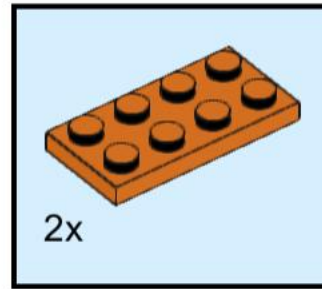

27

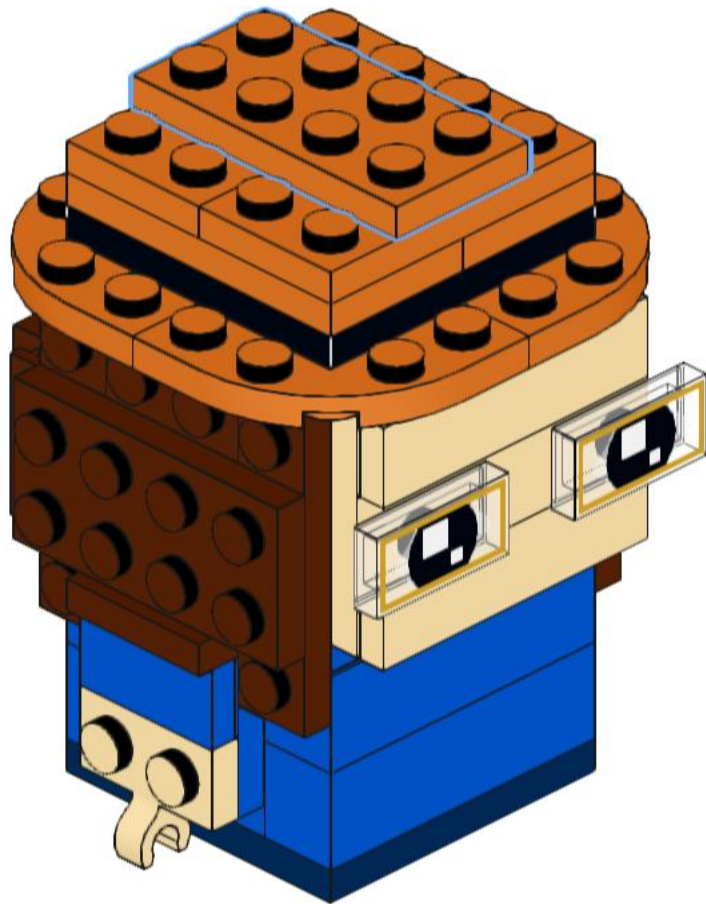
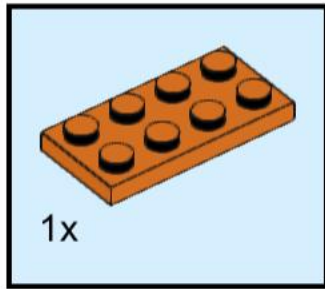

28

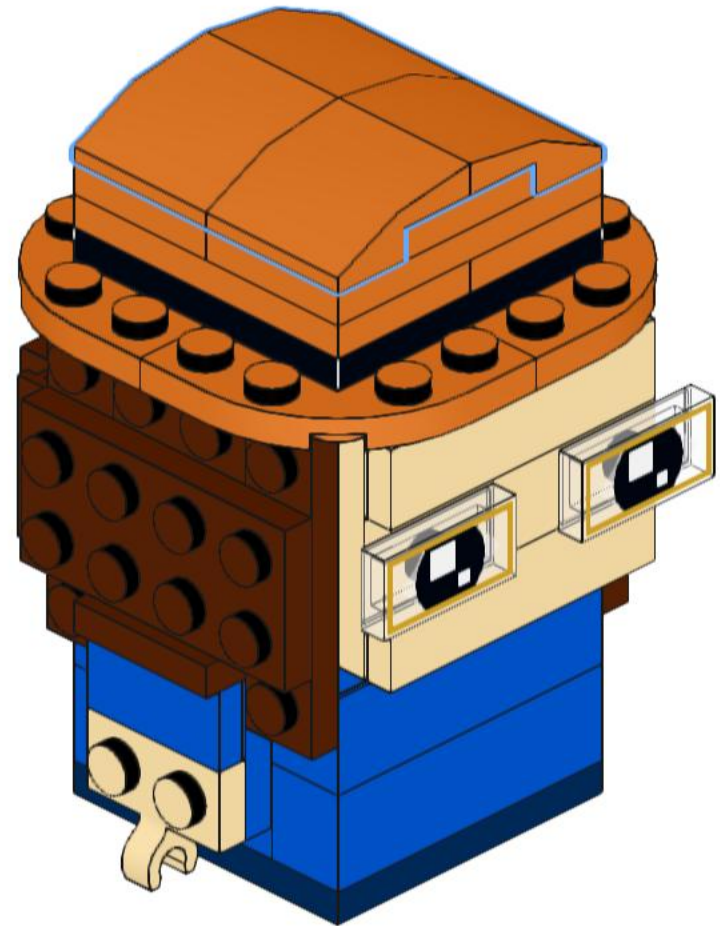
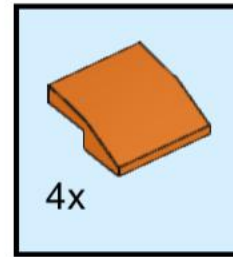

29

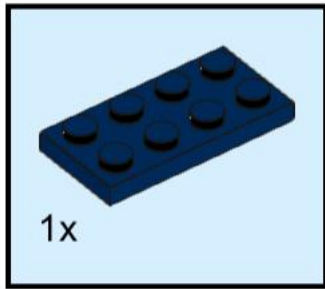

30

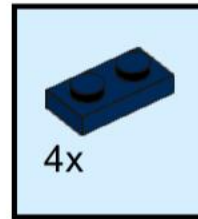

31

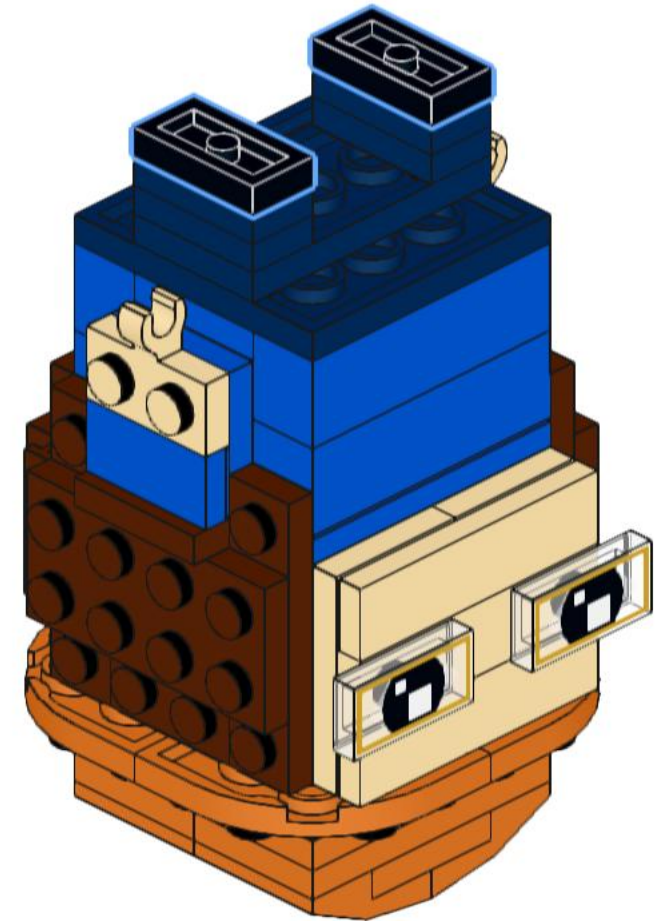
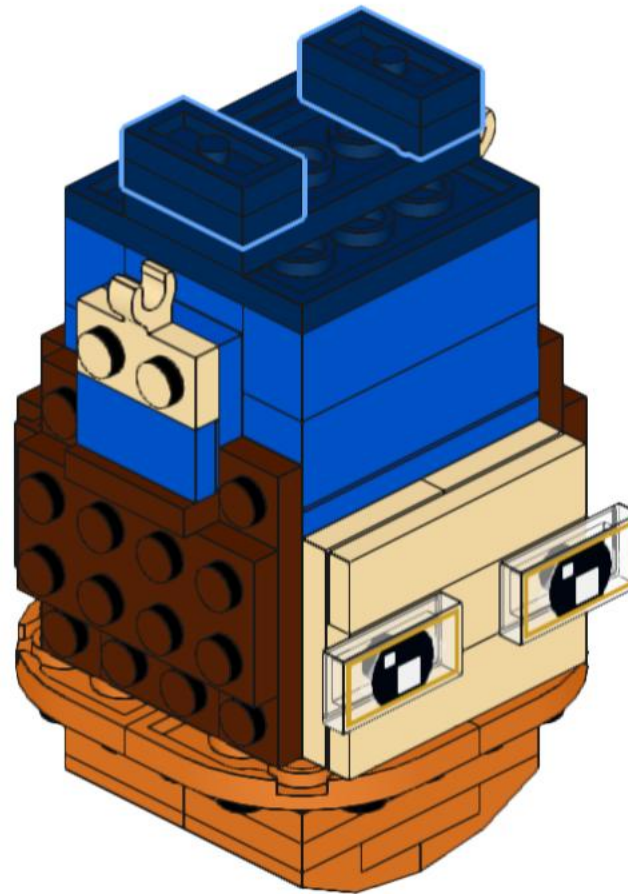
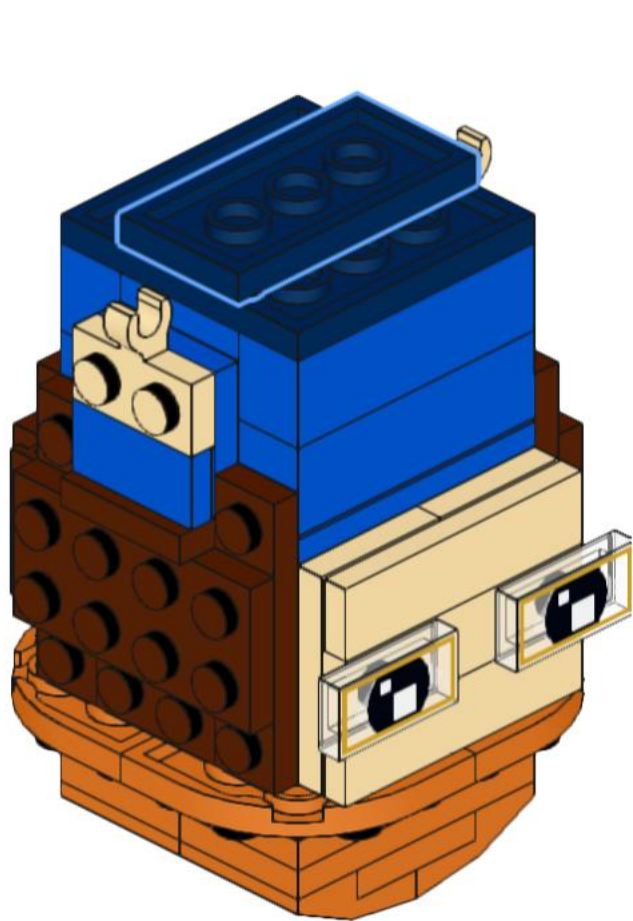
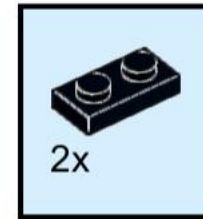

32

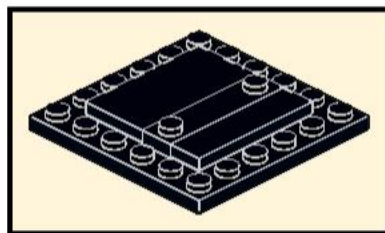
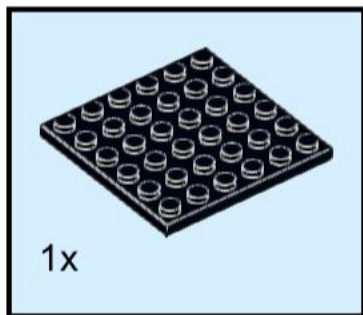

33

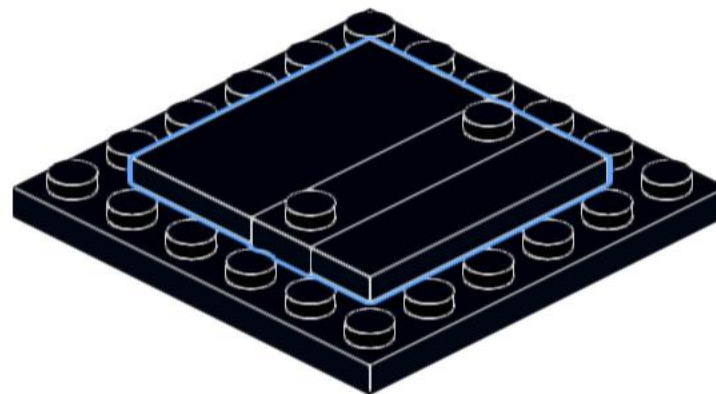
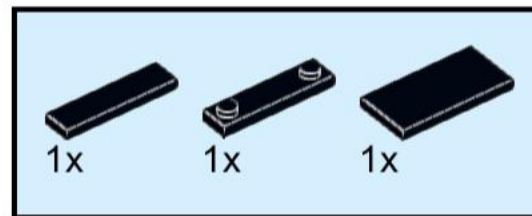

34

