

**ADA  
HEADZ**



**DUNCAN**



[adaheadz.io/manuals](https://adaheadz.io/manuals)



2x



4x



2x



2x



2x



1x



1x



1x



1x



1x



1x



1x



2x



2x



12x



1x

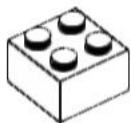

2x

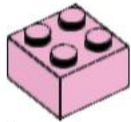

1x



4x



8x



2x



1x



2x



4x



4x



2x



8x



1x



2x



1x



1x



4x



1x



1x



1x



2x



2x



2x

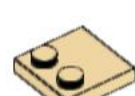

2x



2x

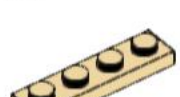

1x

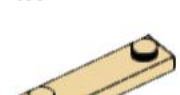

1x

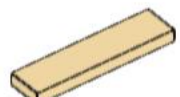

1x



1x



2x



4x



2x



2x



1x



2x



3x



1x

1

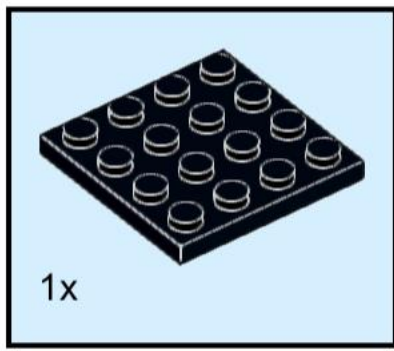

2

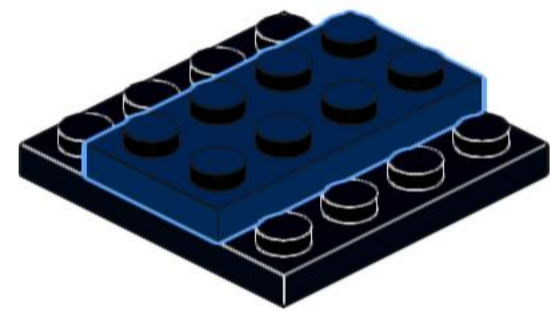
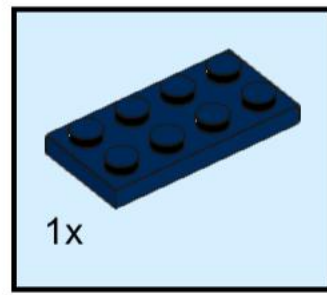

3

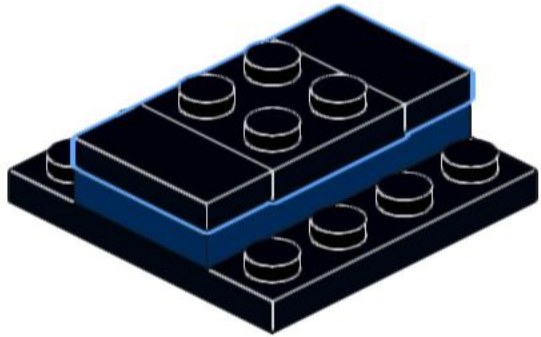
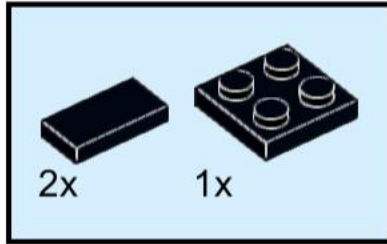

4

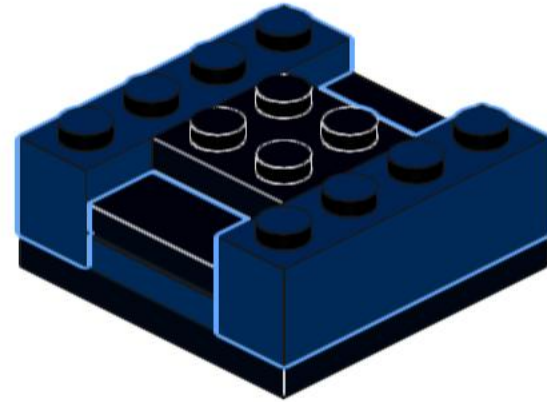
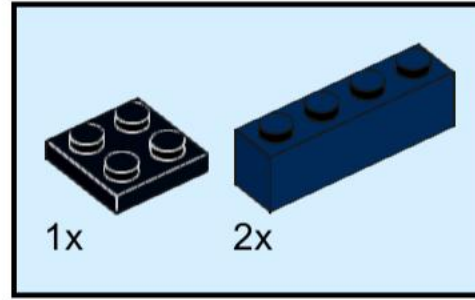

# 5

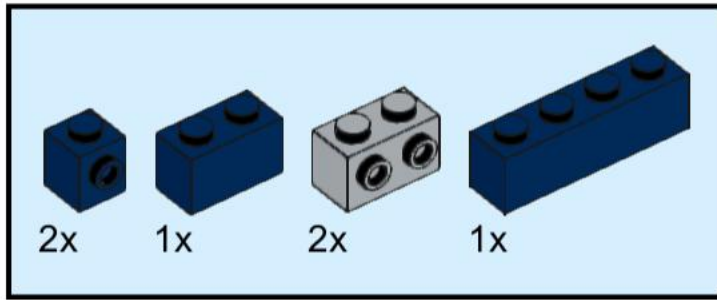

# 6

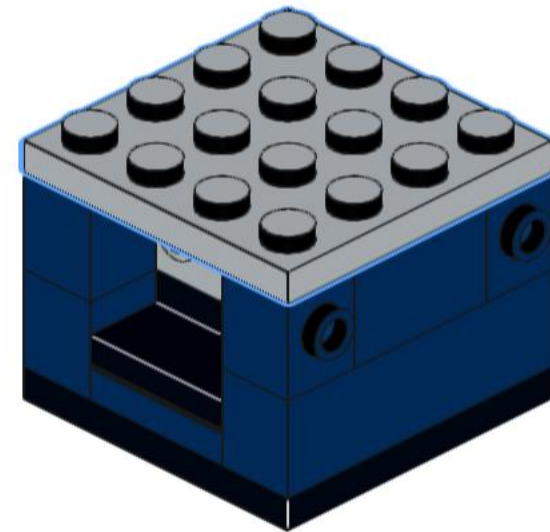
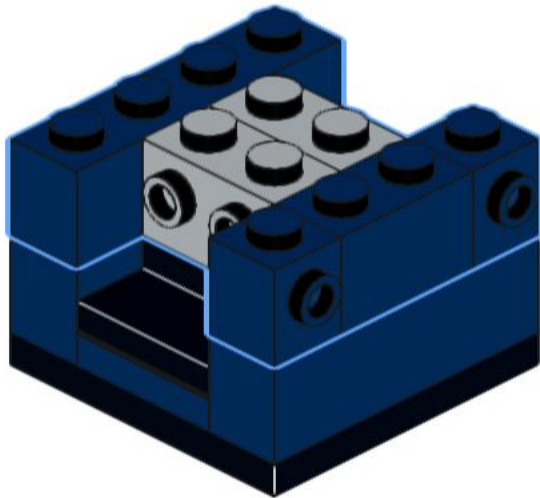
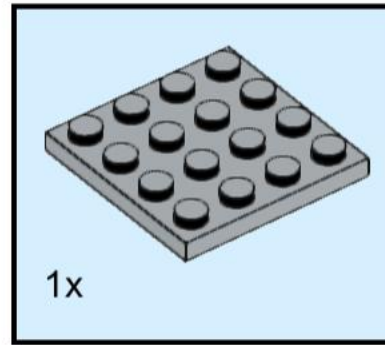

7

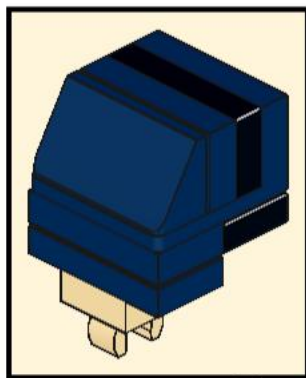
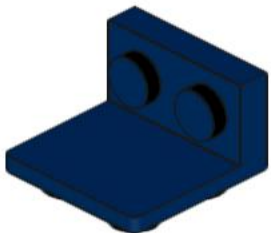
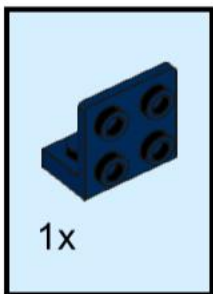

2x

8

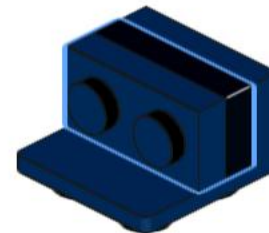
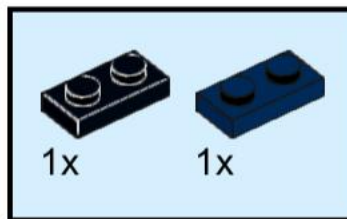

9

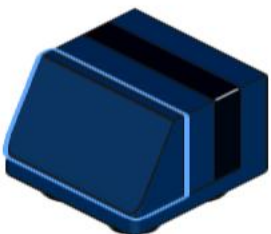
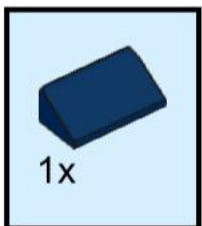

10

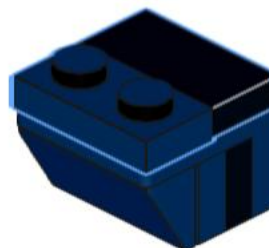
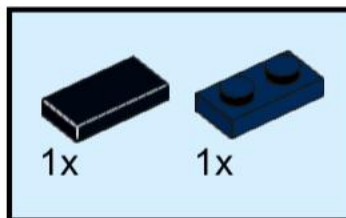



# 11

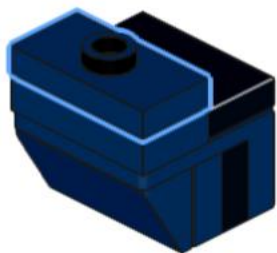
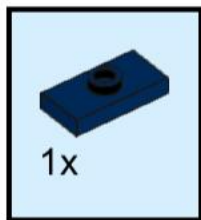

# 12

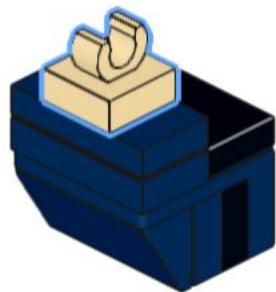
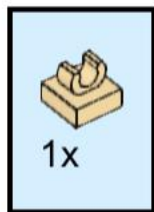

# 13

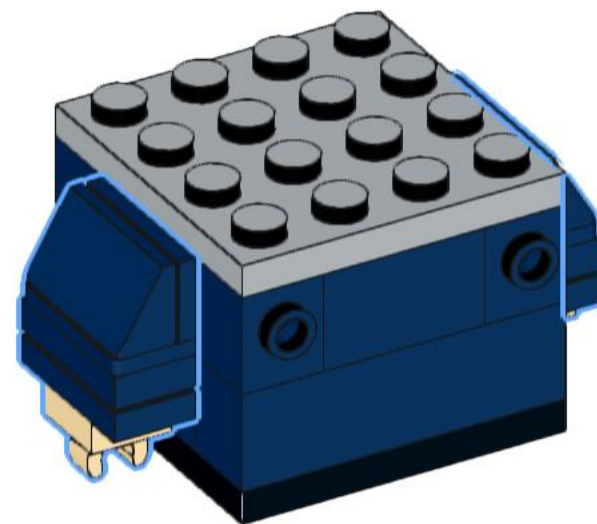

14

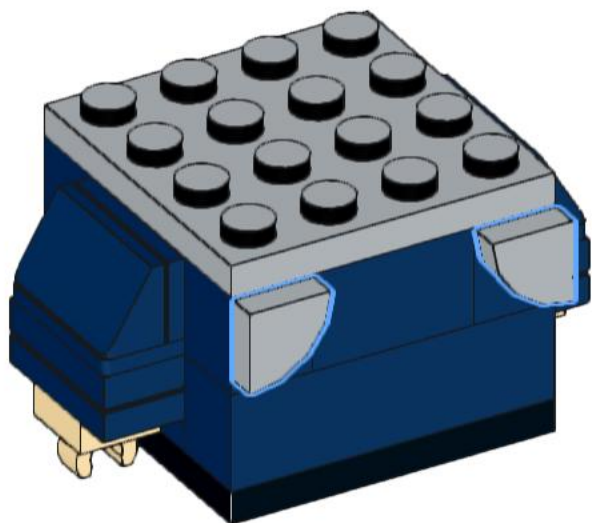
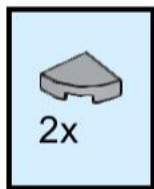

15

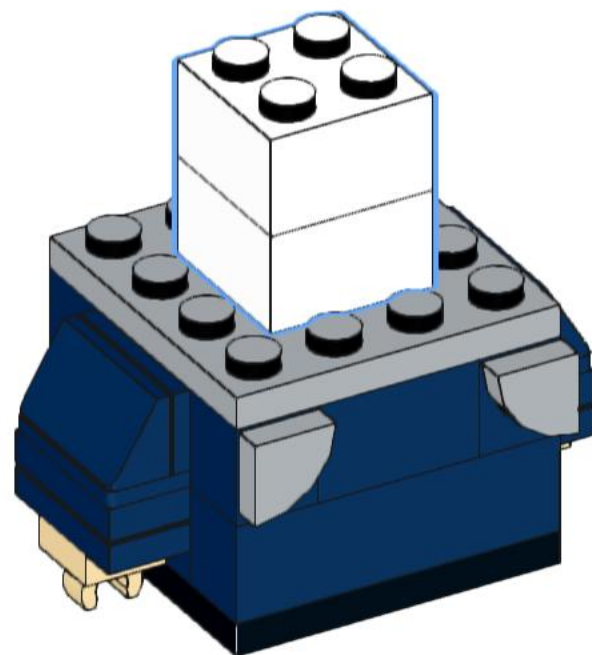
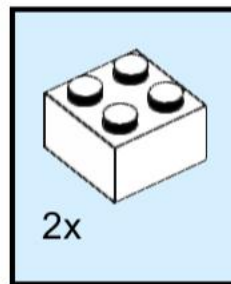



# 16

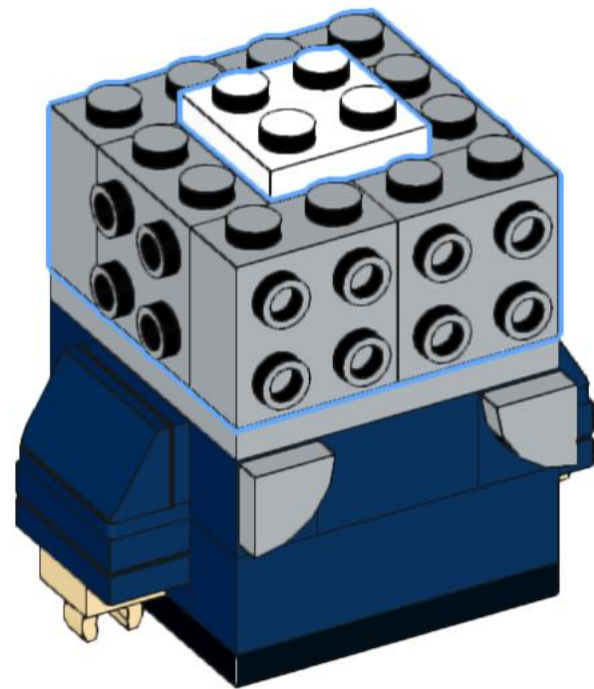
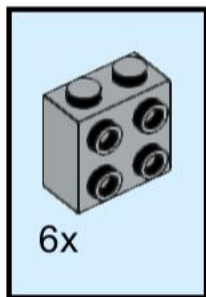

# 17

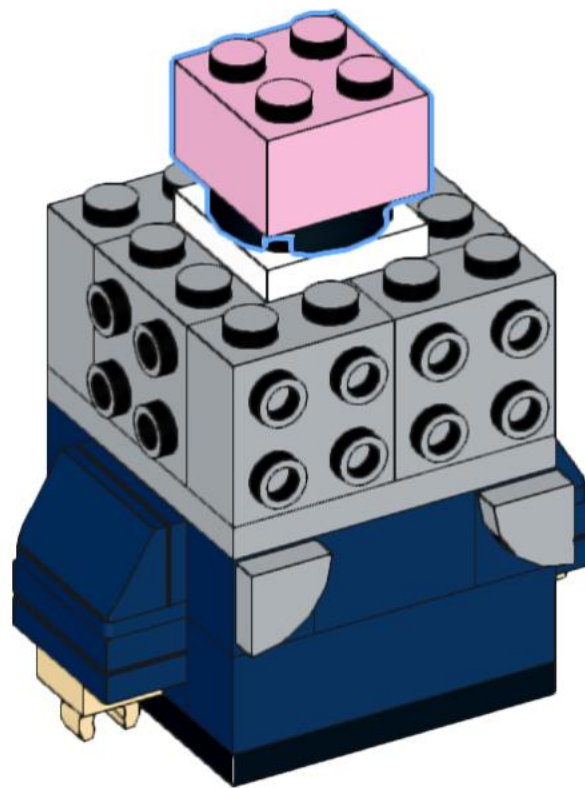
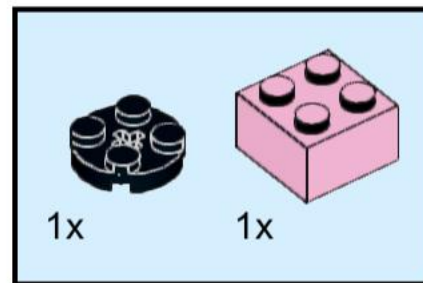

# 18

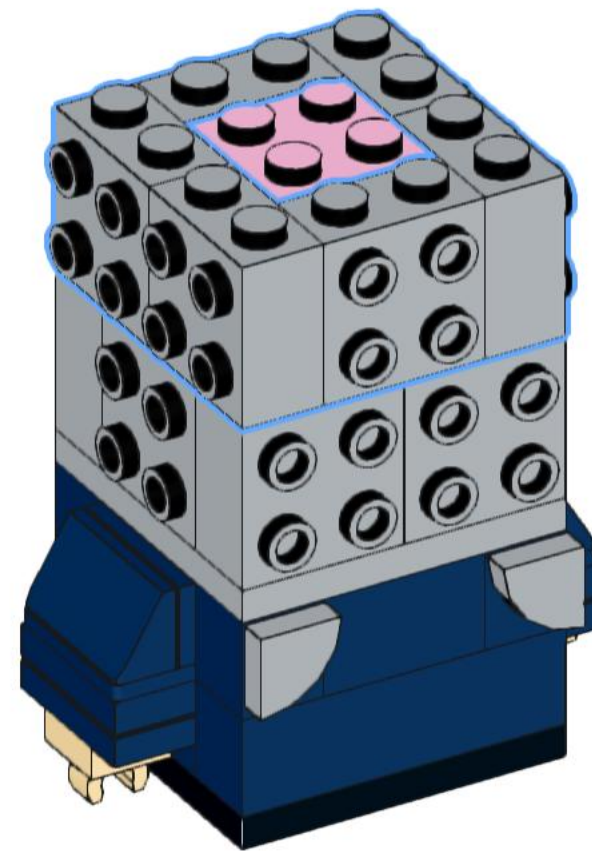
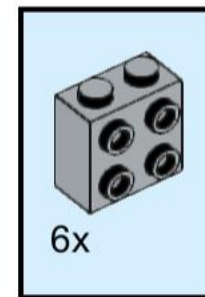

# 19

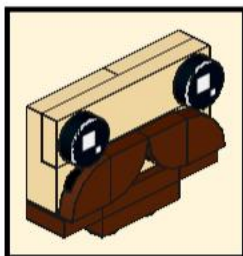
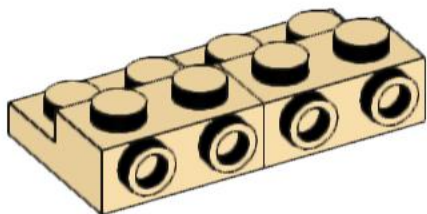
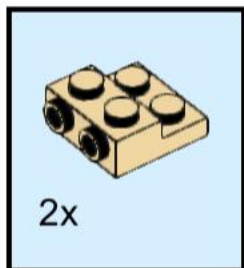

# 20

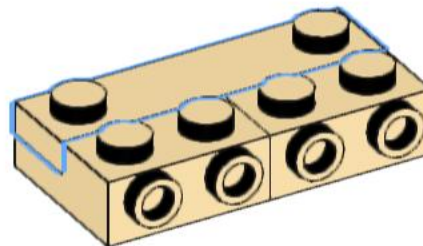
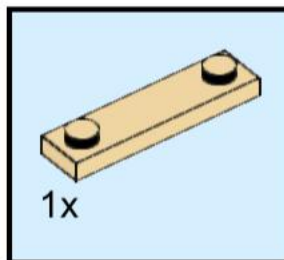

# 21

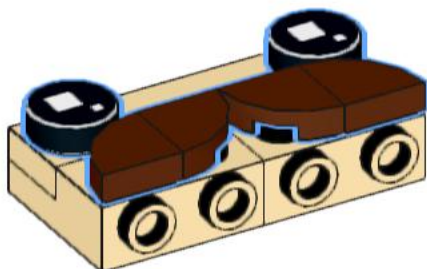

# 22

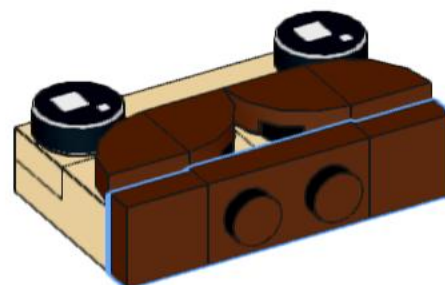
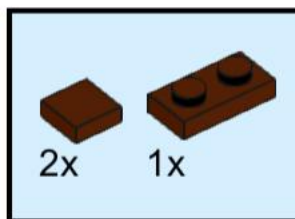

# 23

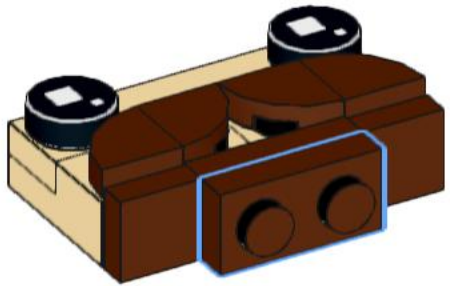
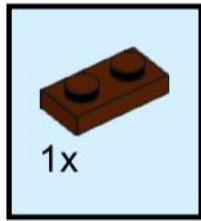

# 24

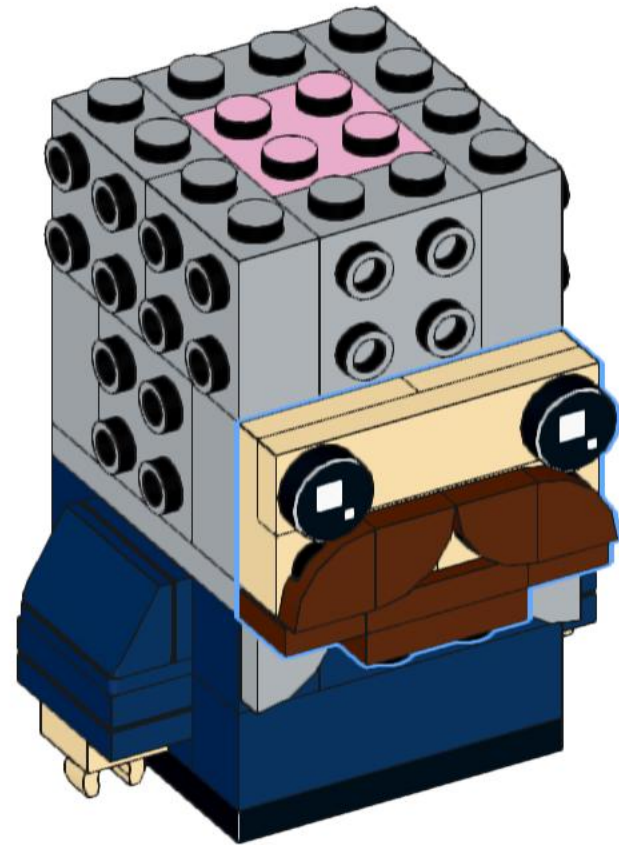

# 25

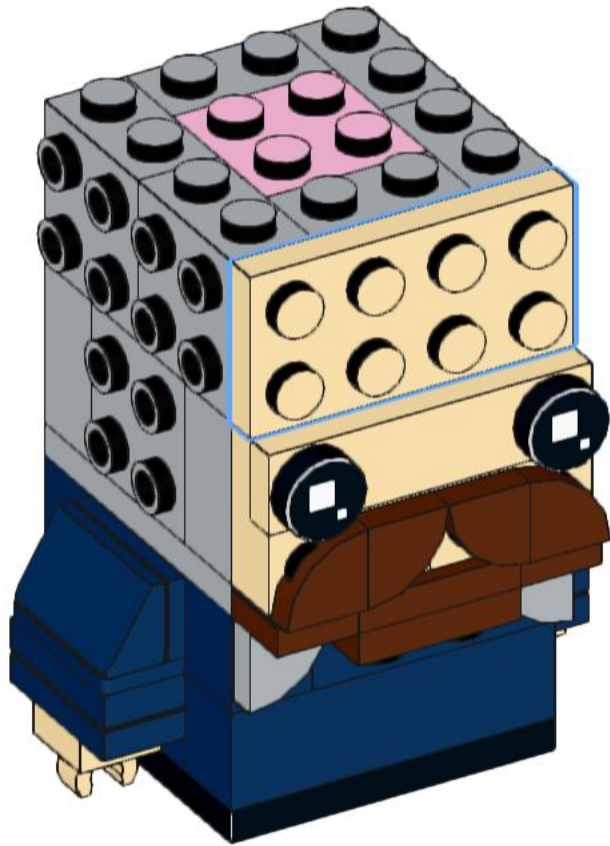
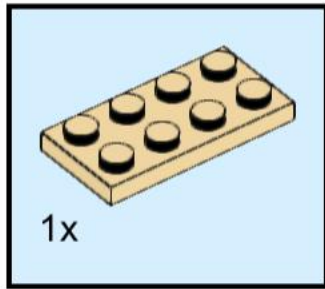

# 26

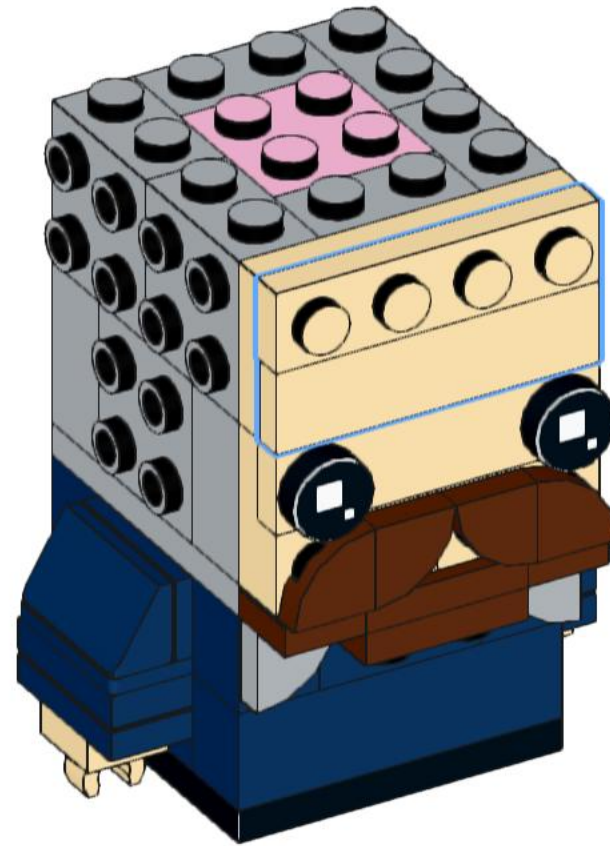
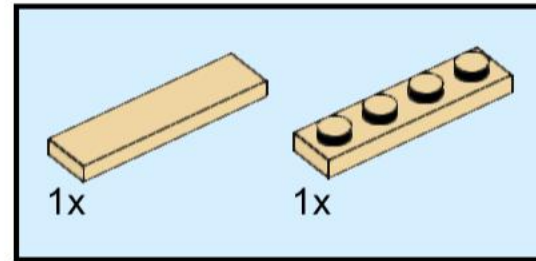



# 27

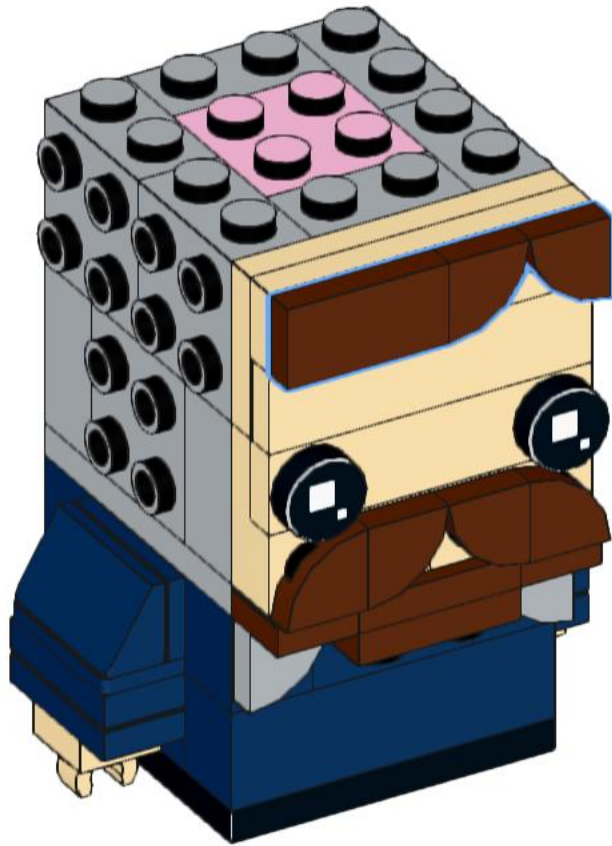
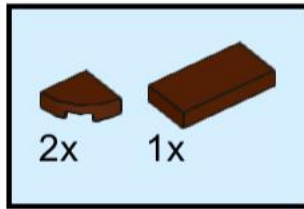

# 28

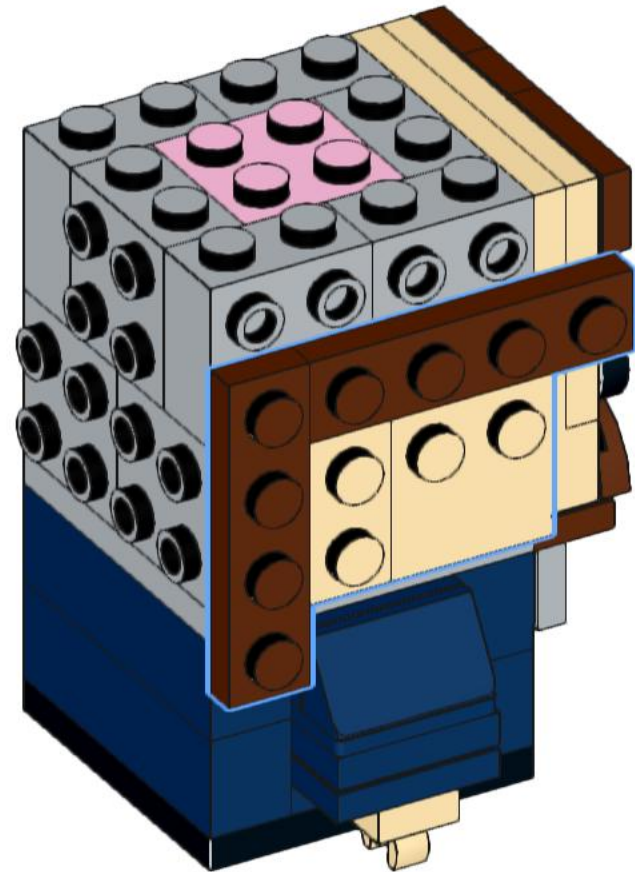
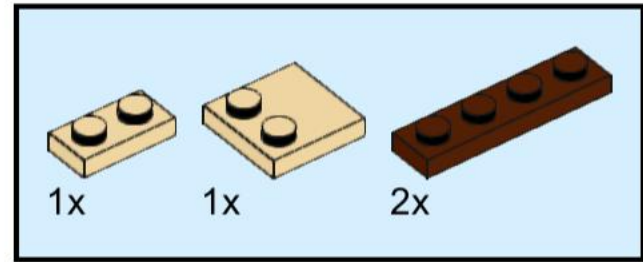

# 29

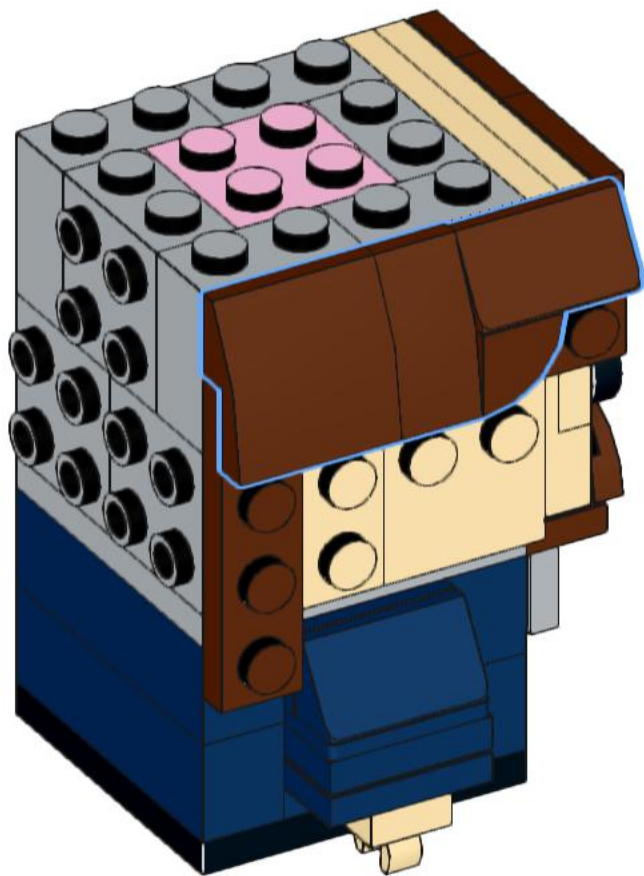
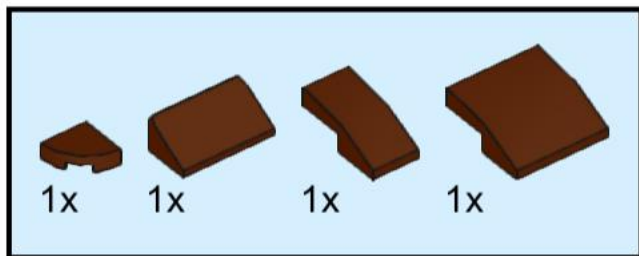

# 30

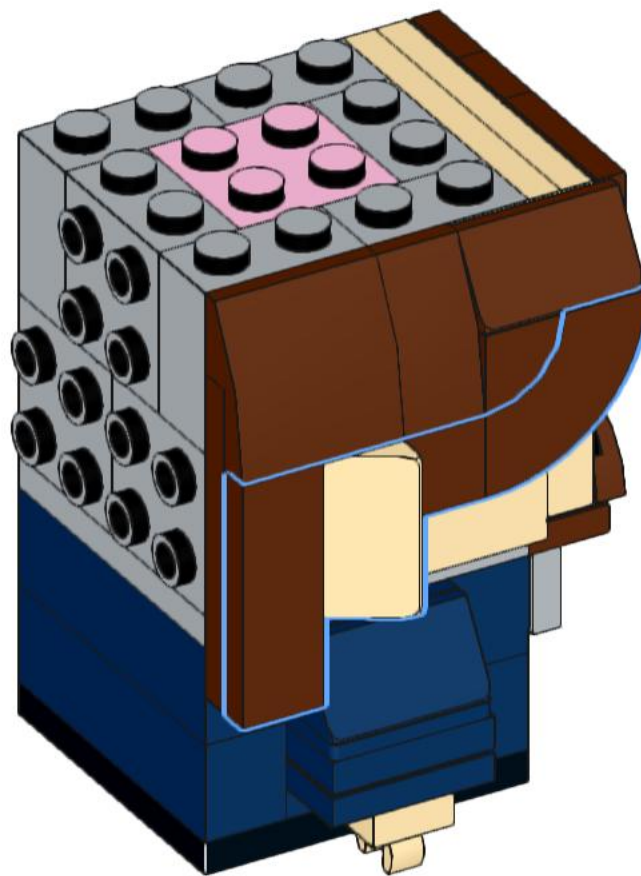
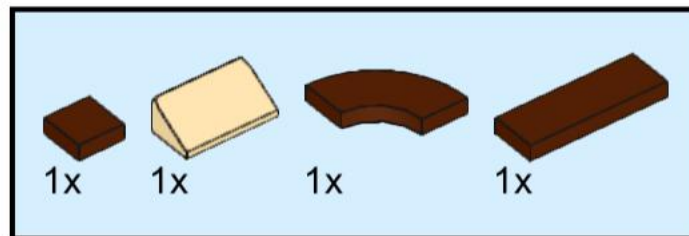

# 31

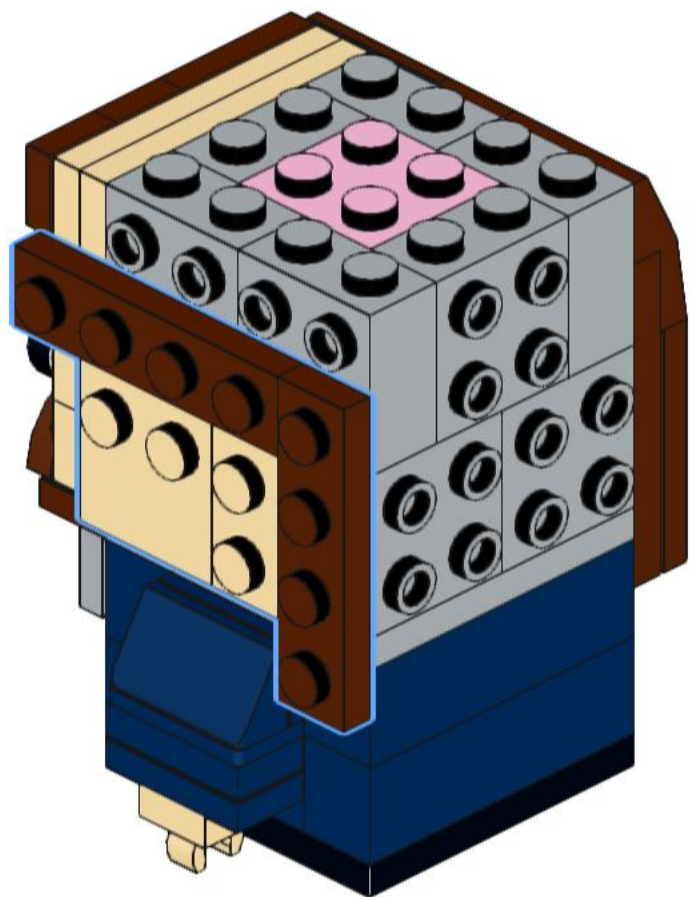
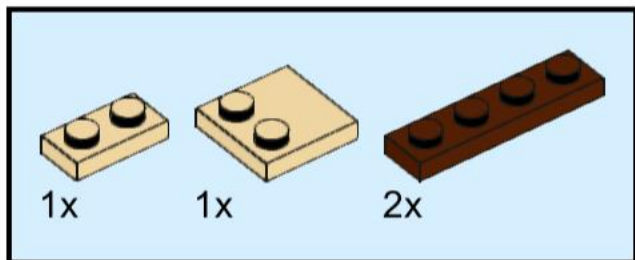

# 32

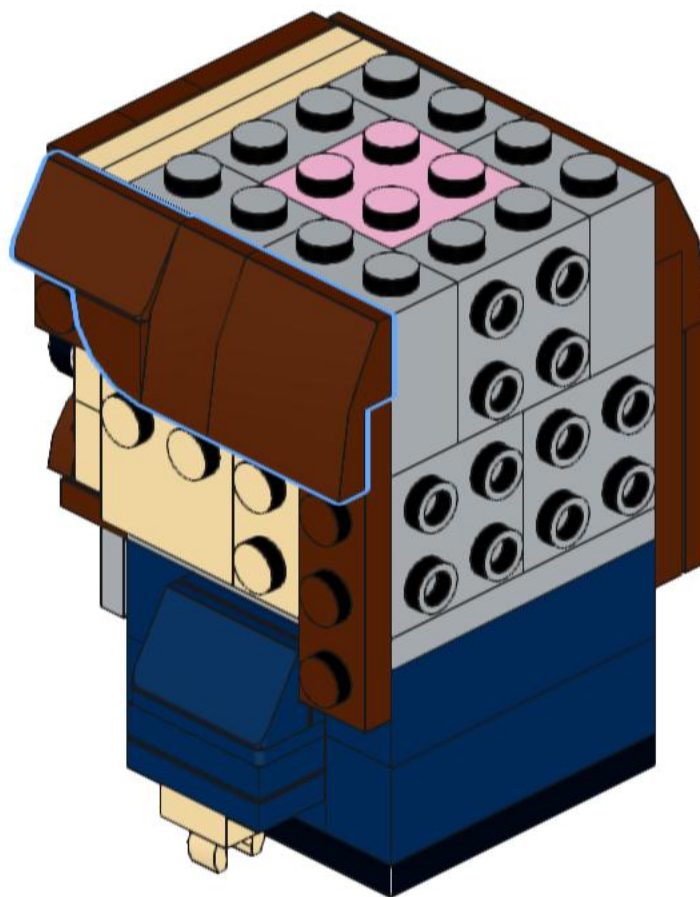
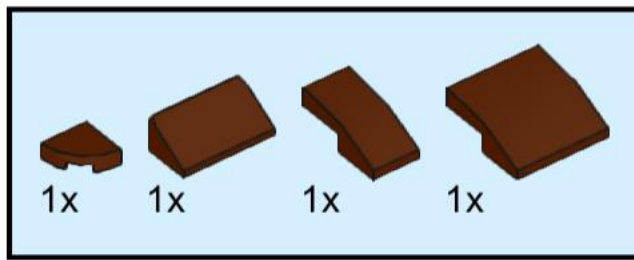



# 33

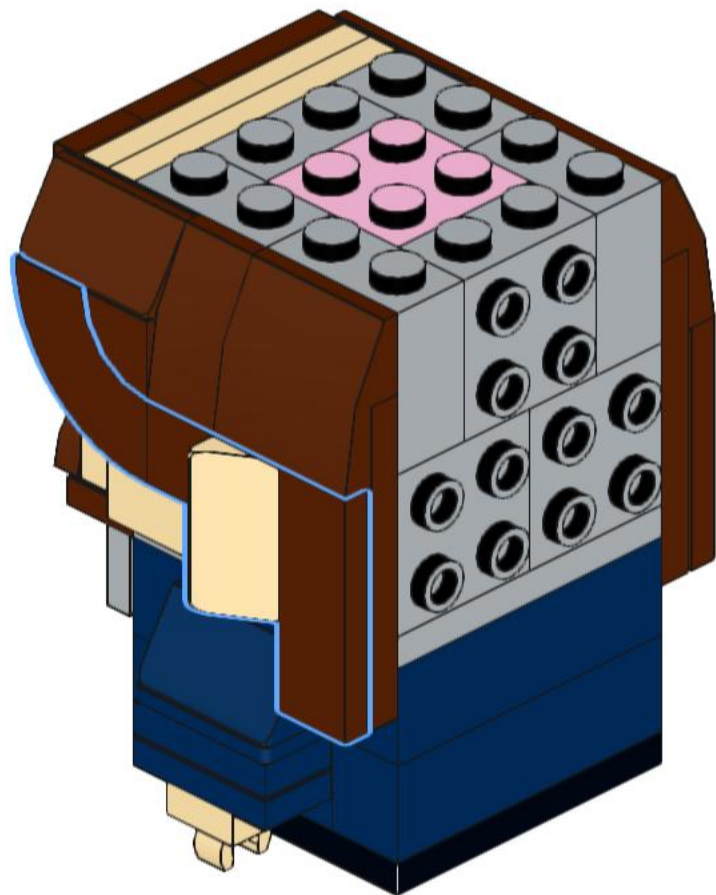
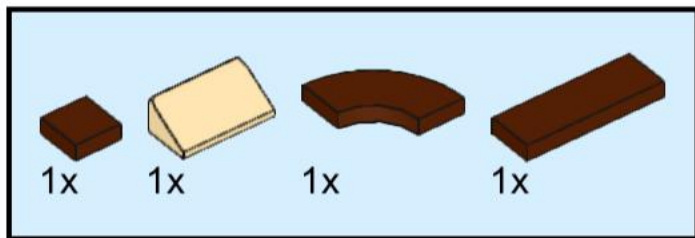

# 34

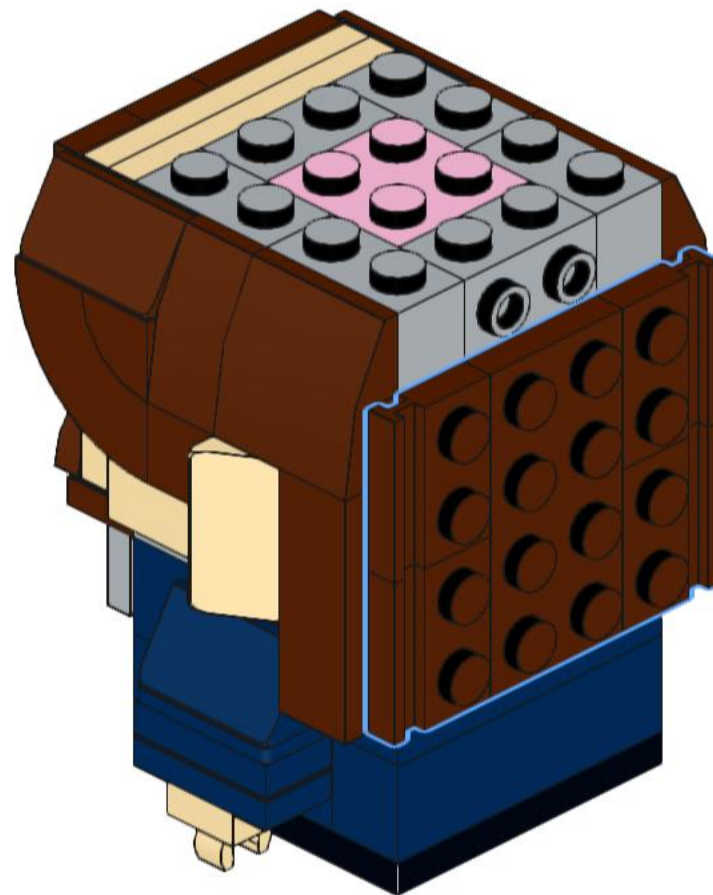
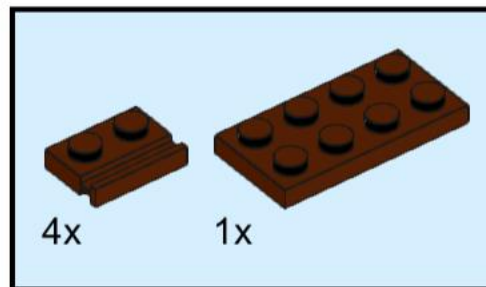

# 35

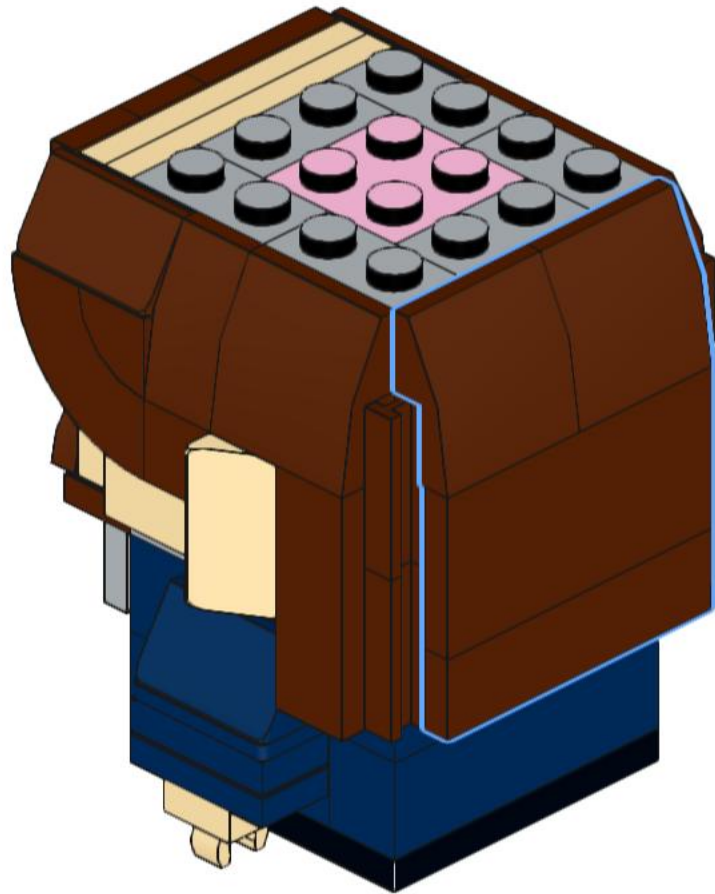
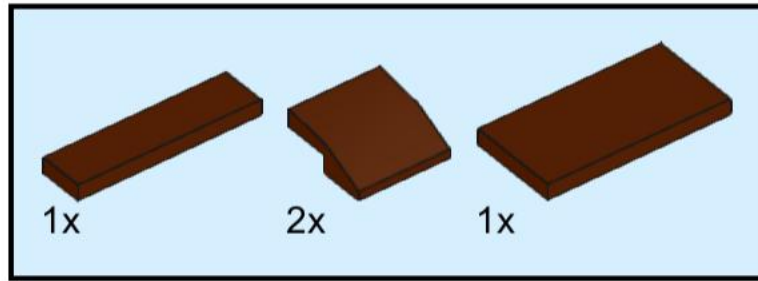

# 36

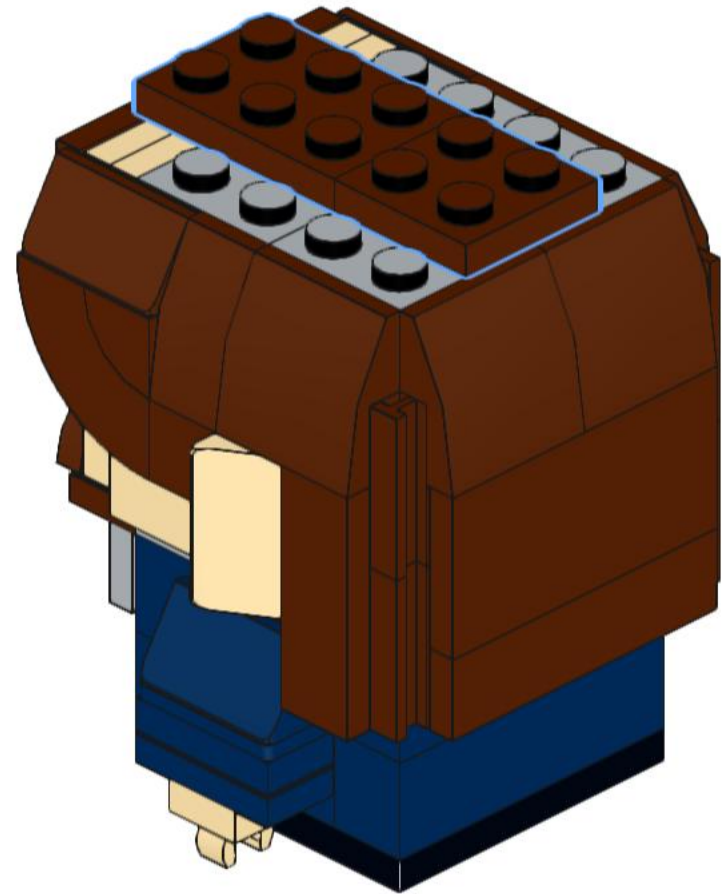
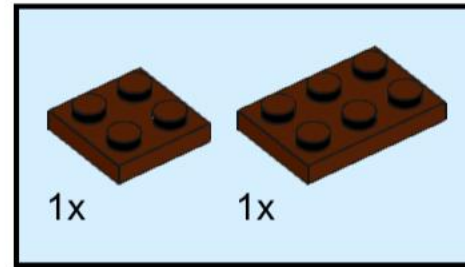

# 37

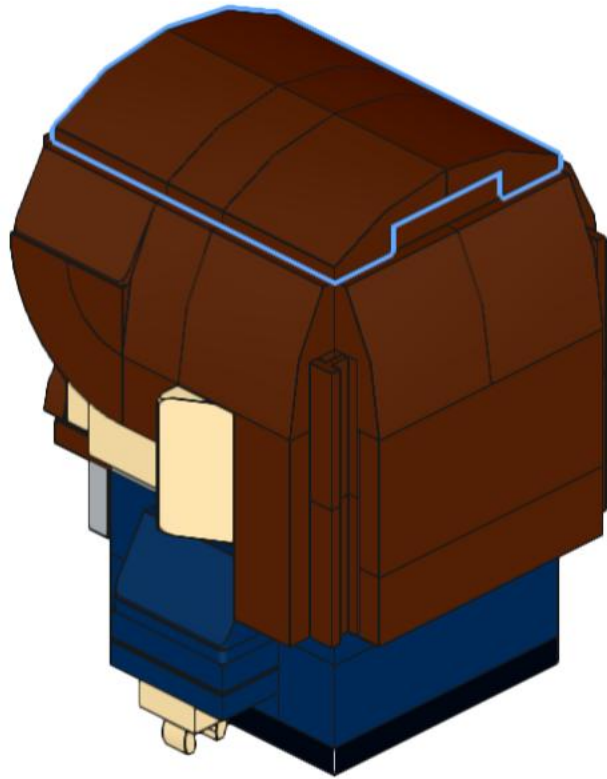
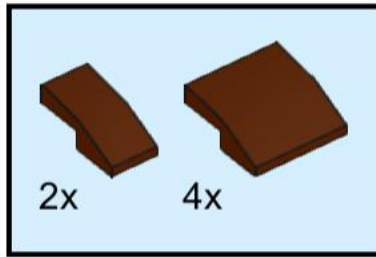

# 38

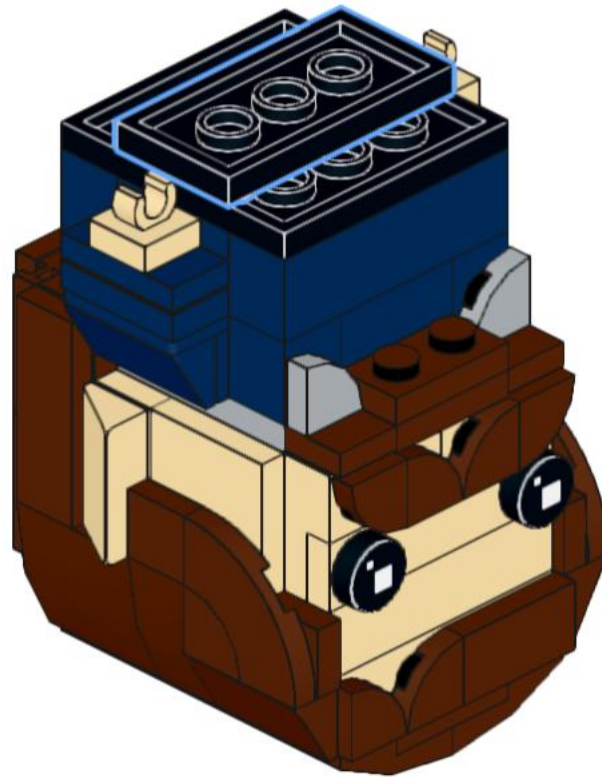
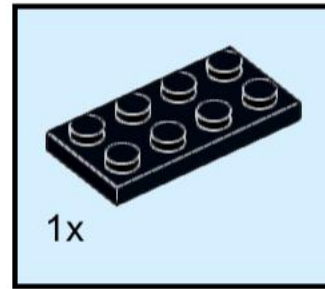

# 39

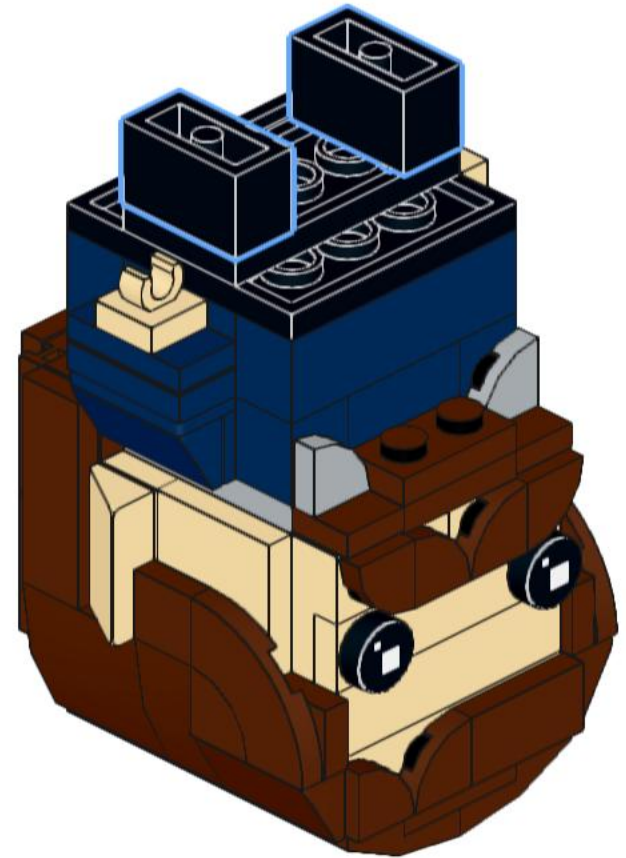
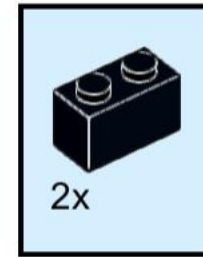



# 40

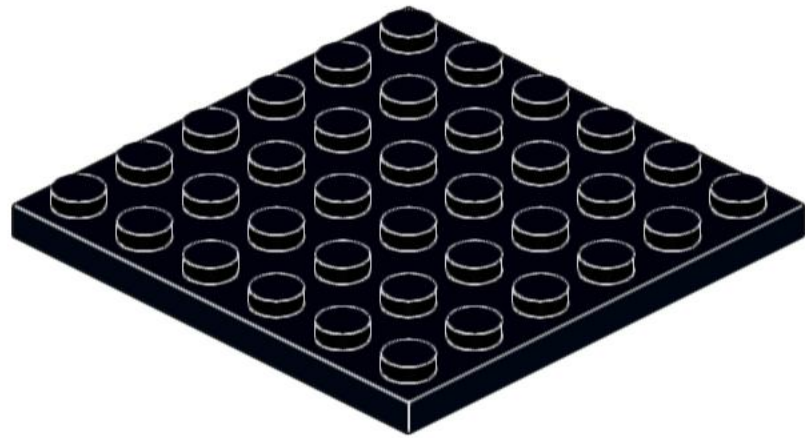
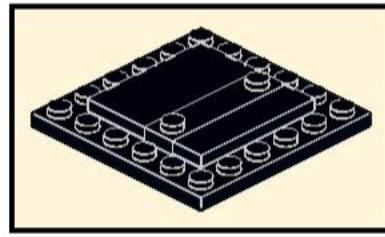
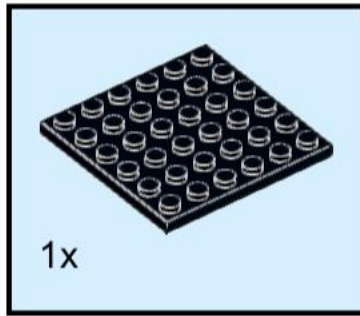

# 41

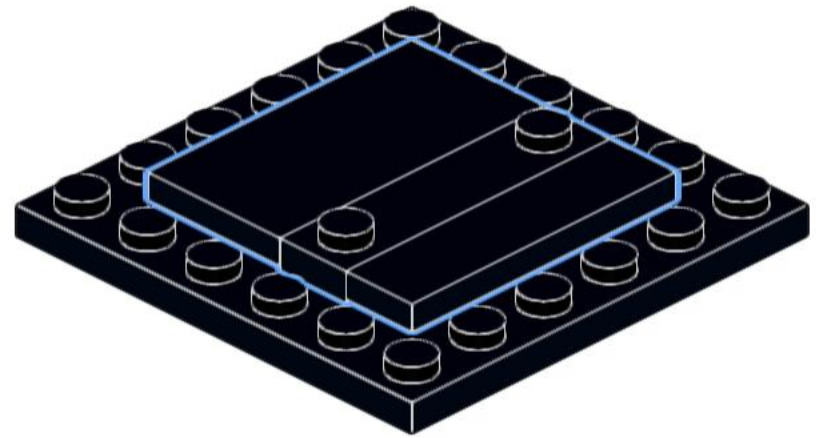
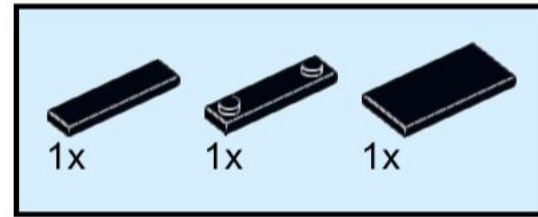

42

