

**ADA  
HEADZ**

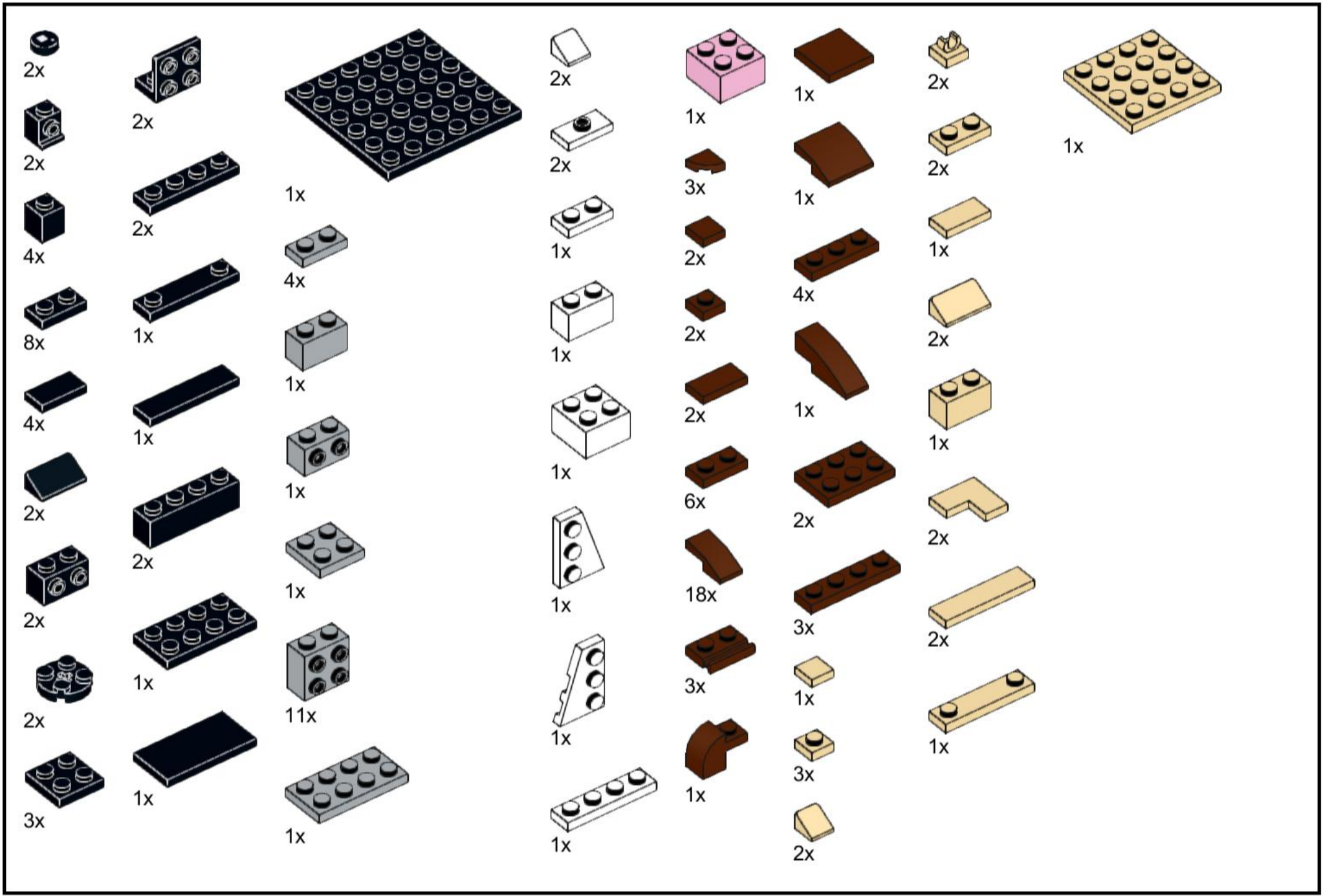

[adaheadz.io/manuals](https://adaheadz.io/manuals)

**SHELLEY**



1

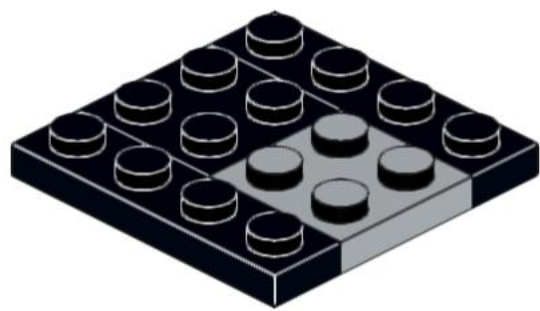
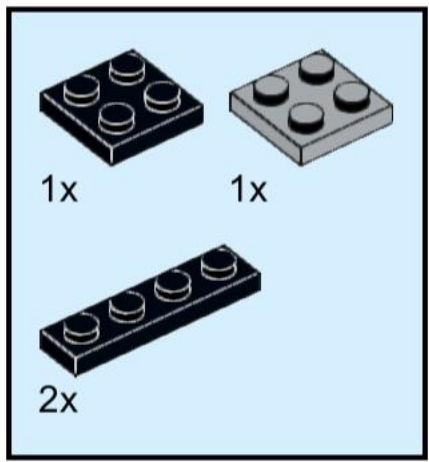

2

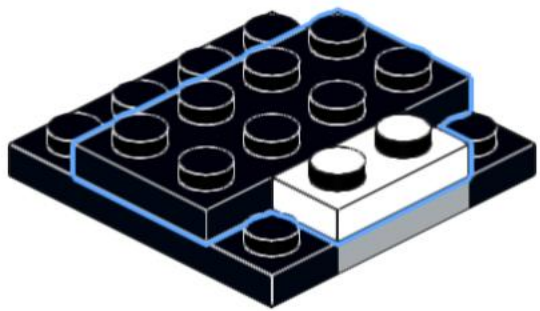
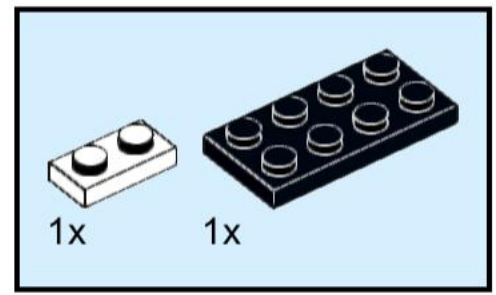

3

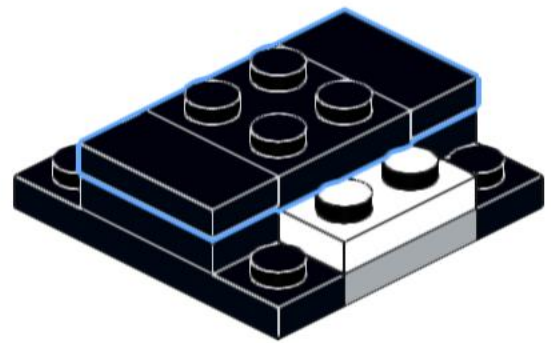
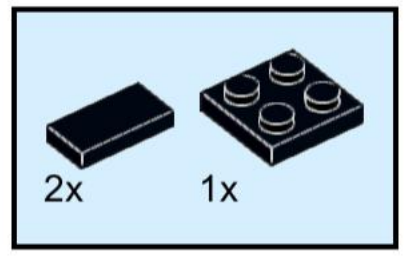

# 4

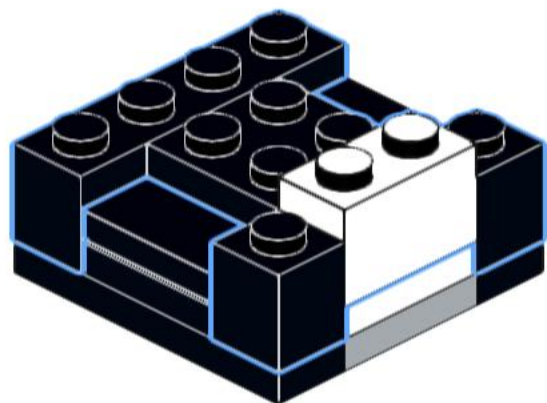
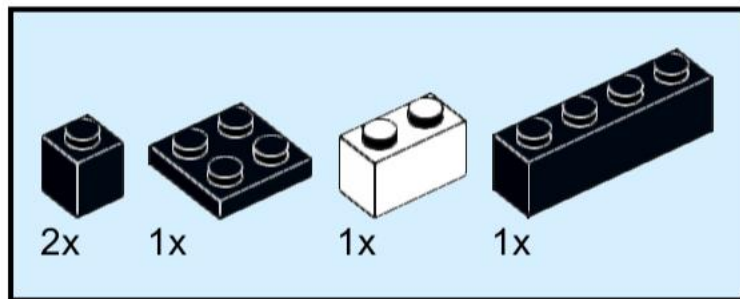

# 5

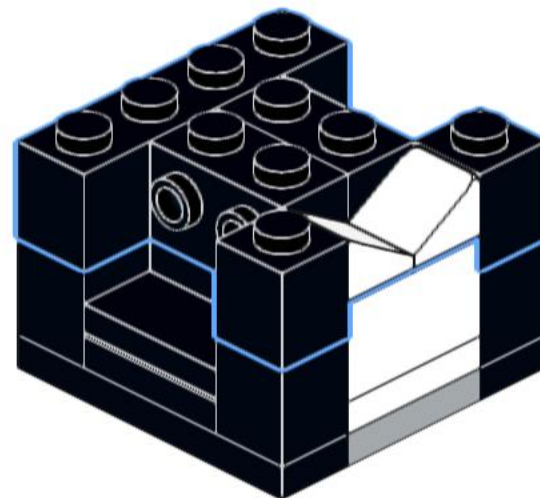
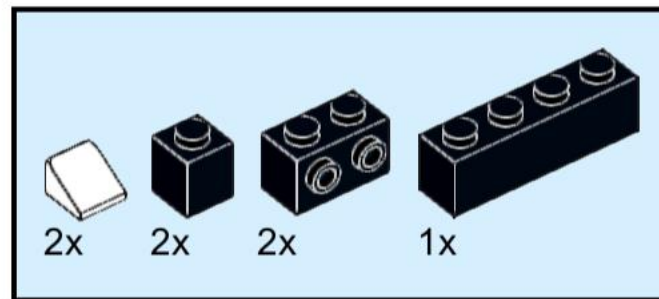

6

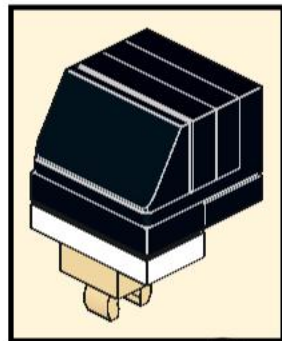
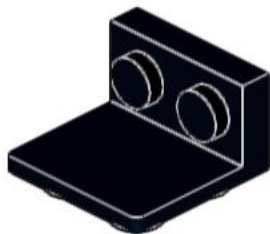
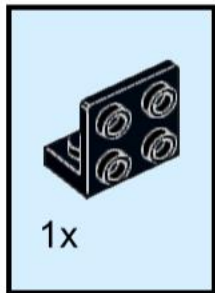

2x

7

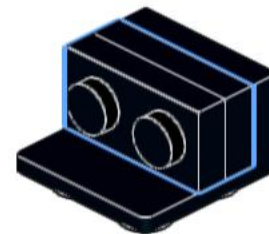
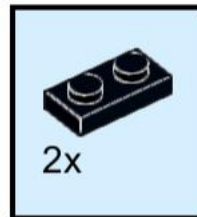

8

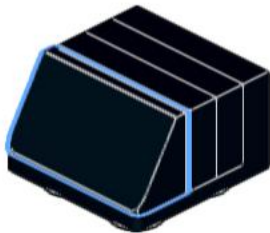
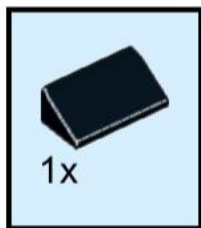

9

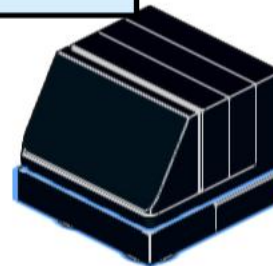
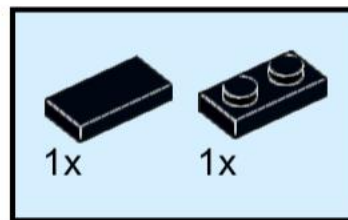

# 10

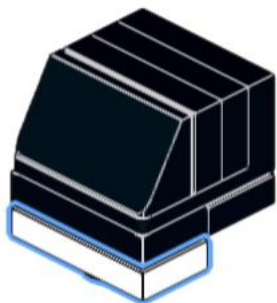
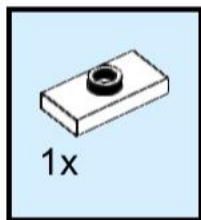

# 11

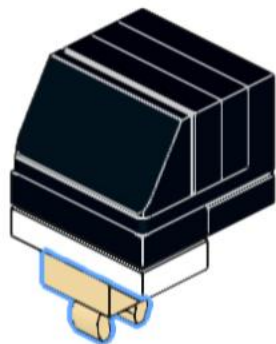
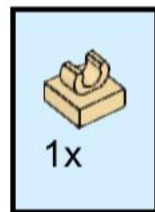

# 12

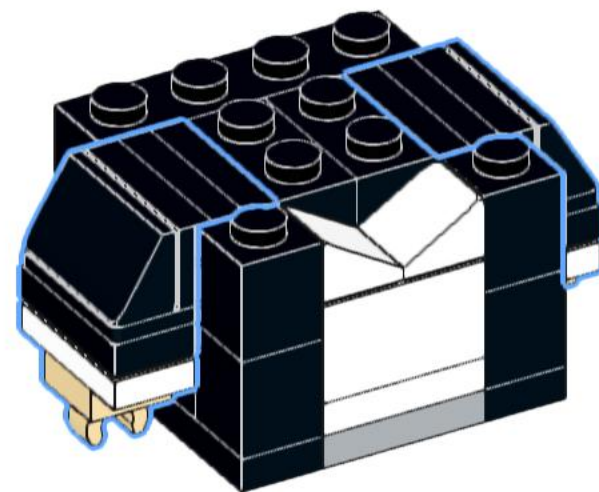

# 13

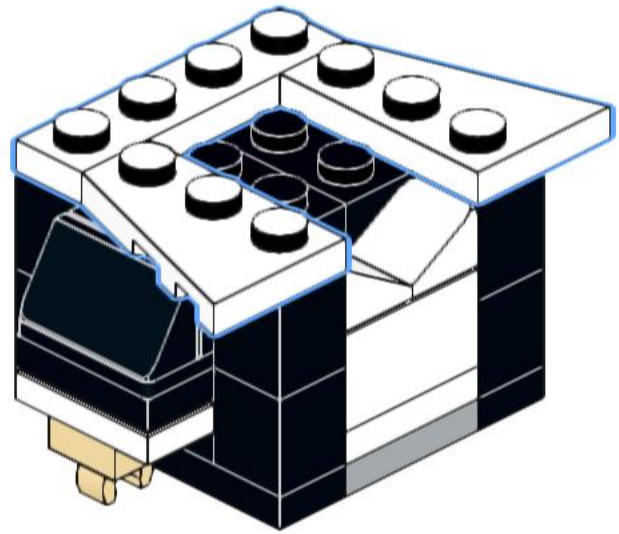
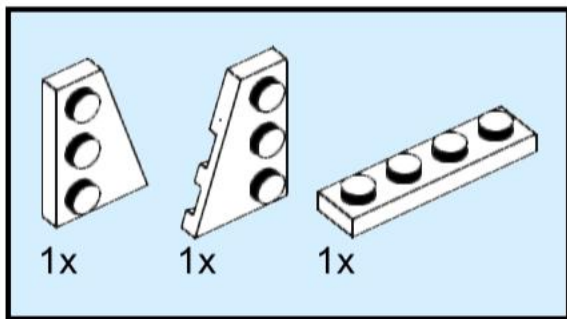

# 14

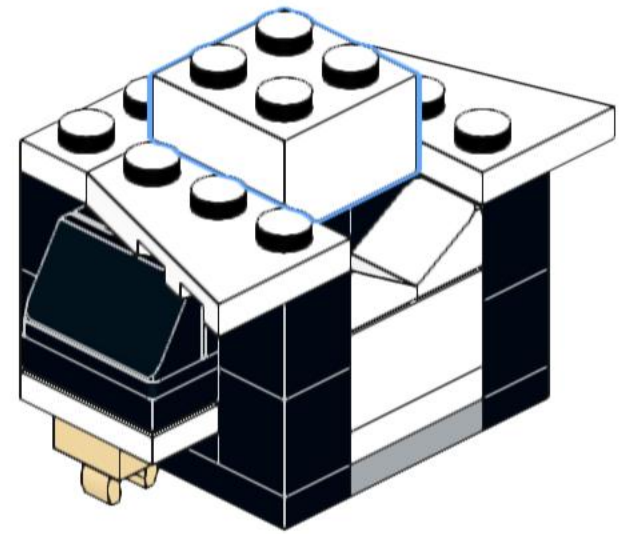
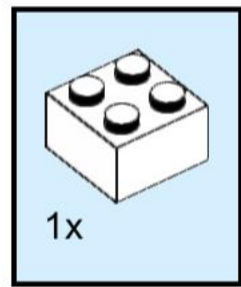

# 15

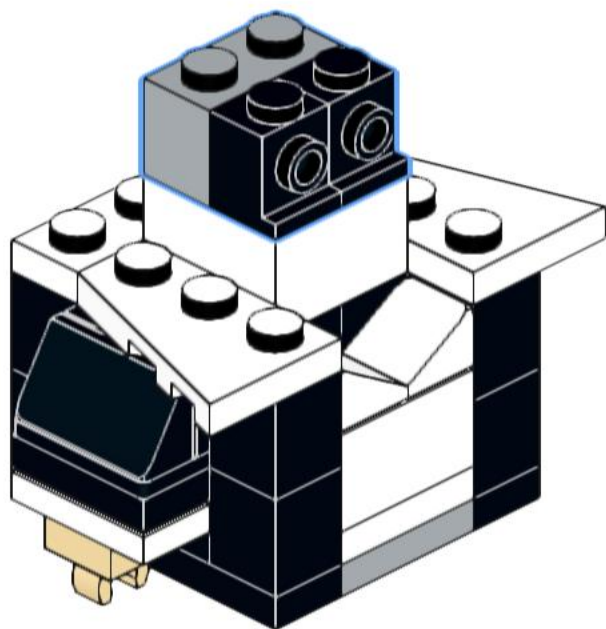
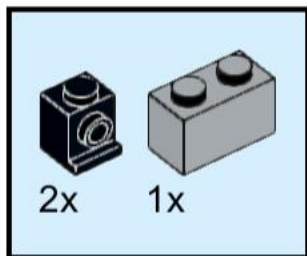

# 16

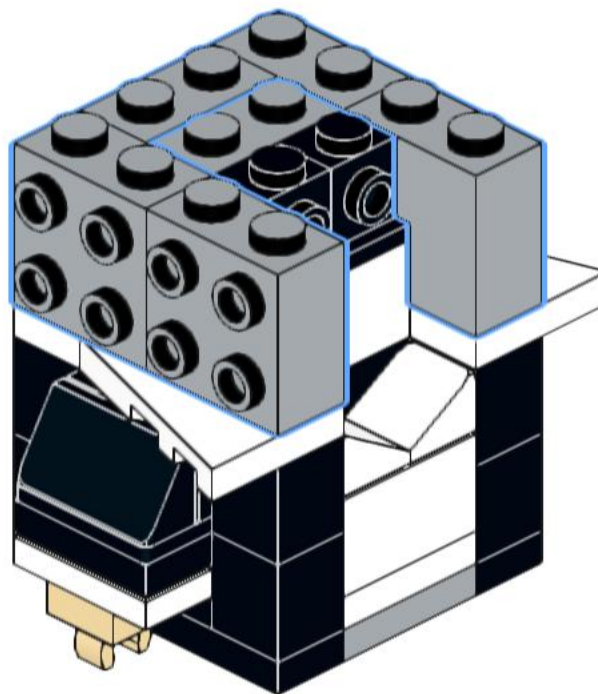
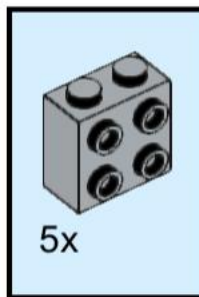



# 17

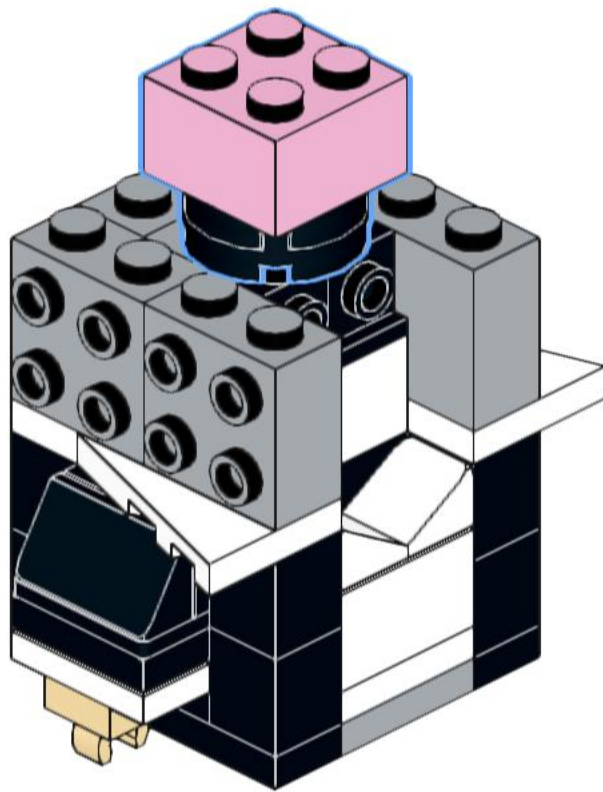
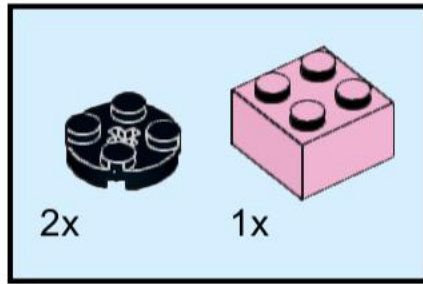

# 18

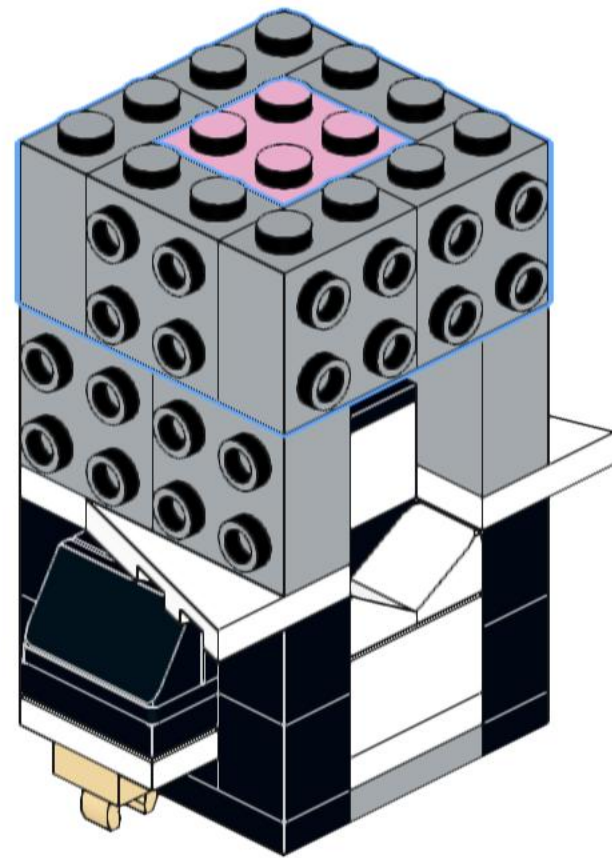
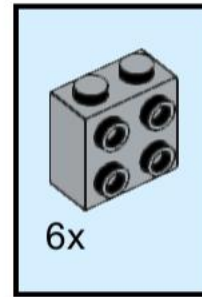

# 19

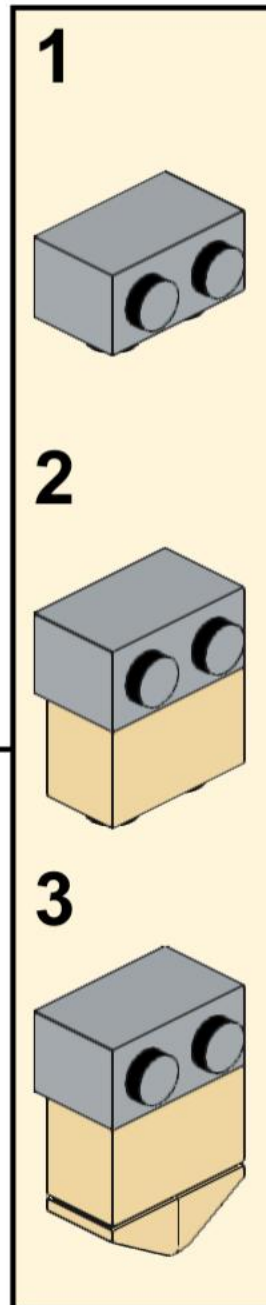
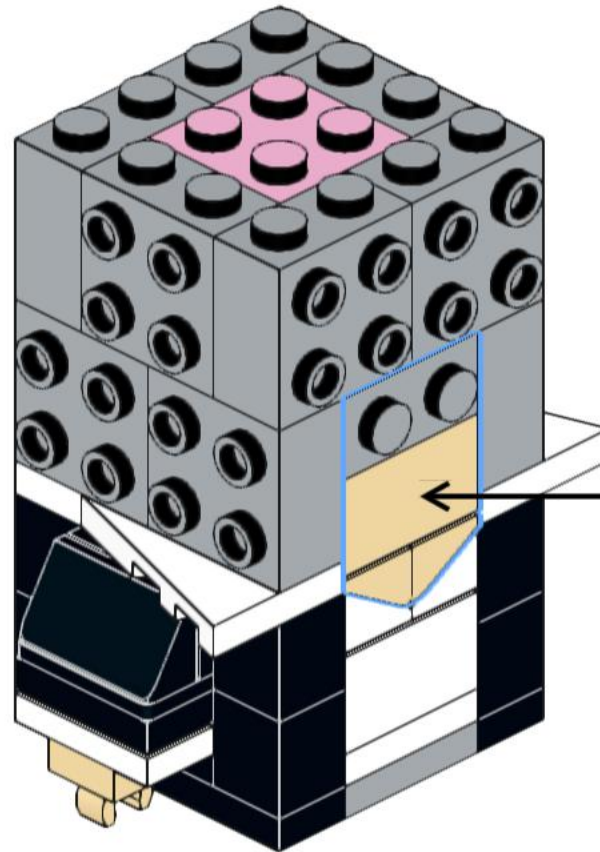
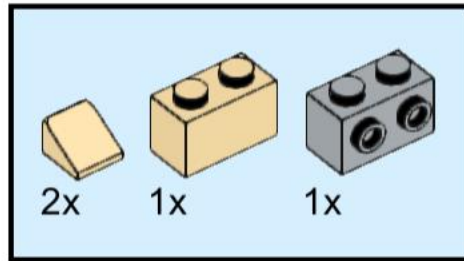

# 20

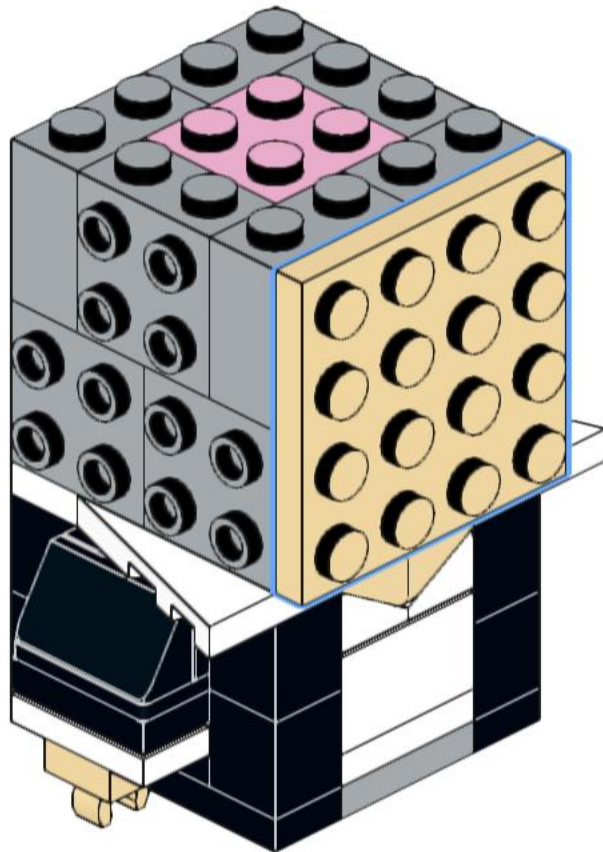
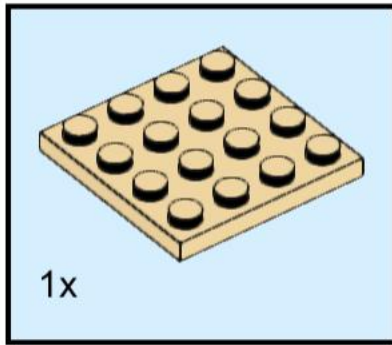

# 21

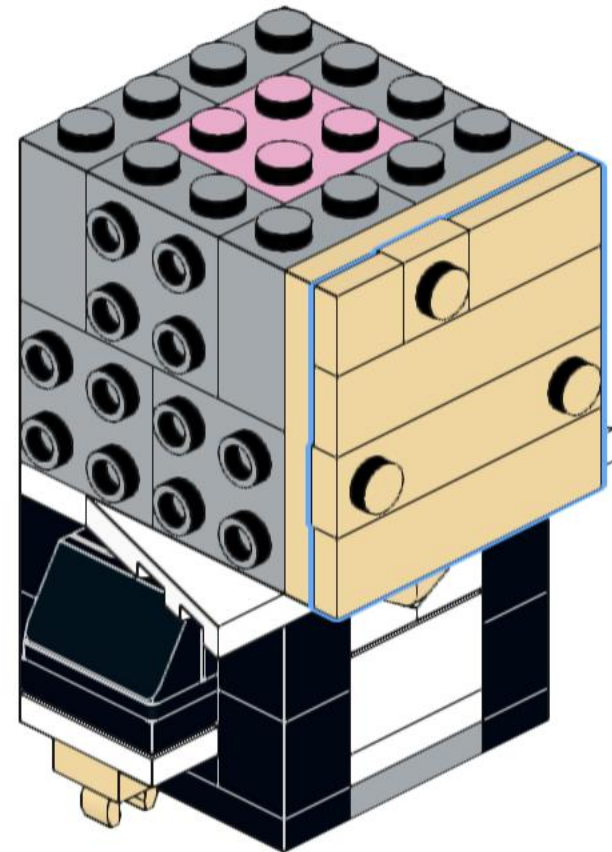
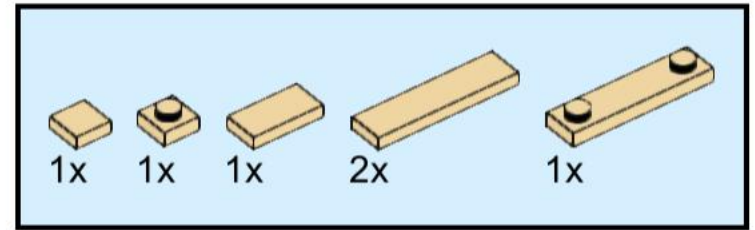

# 22

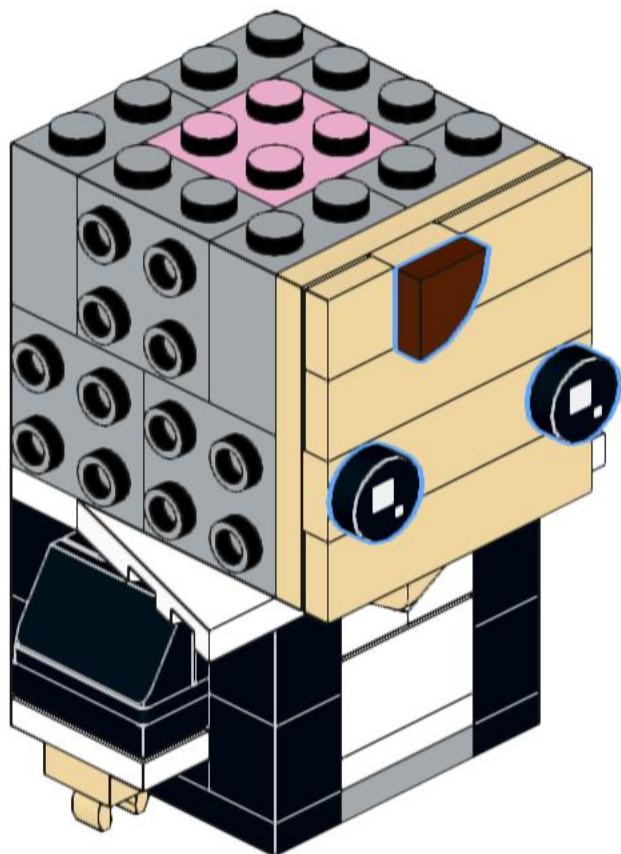

# 23

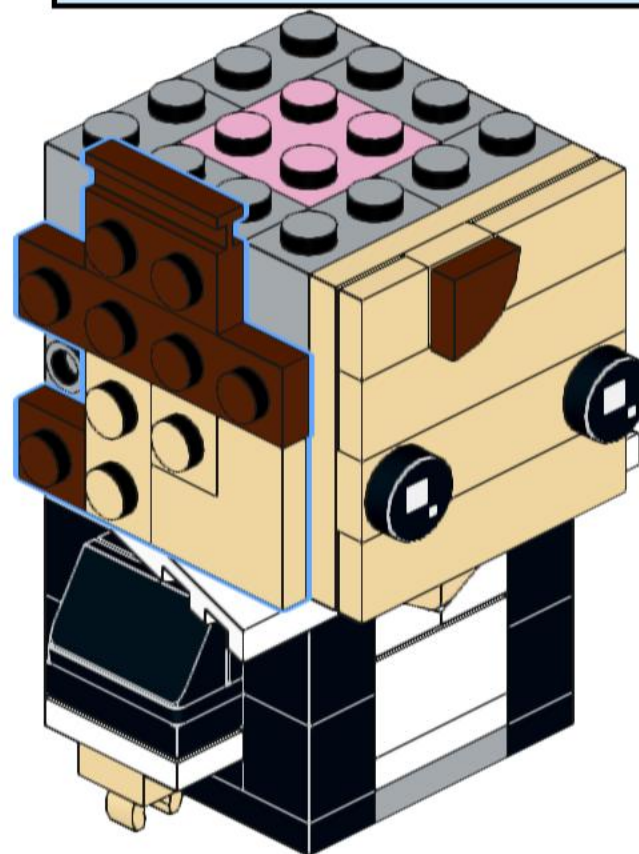
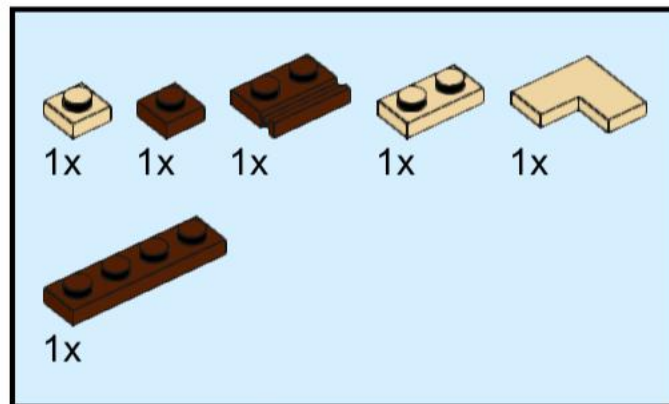

# 24

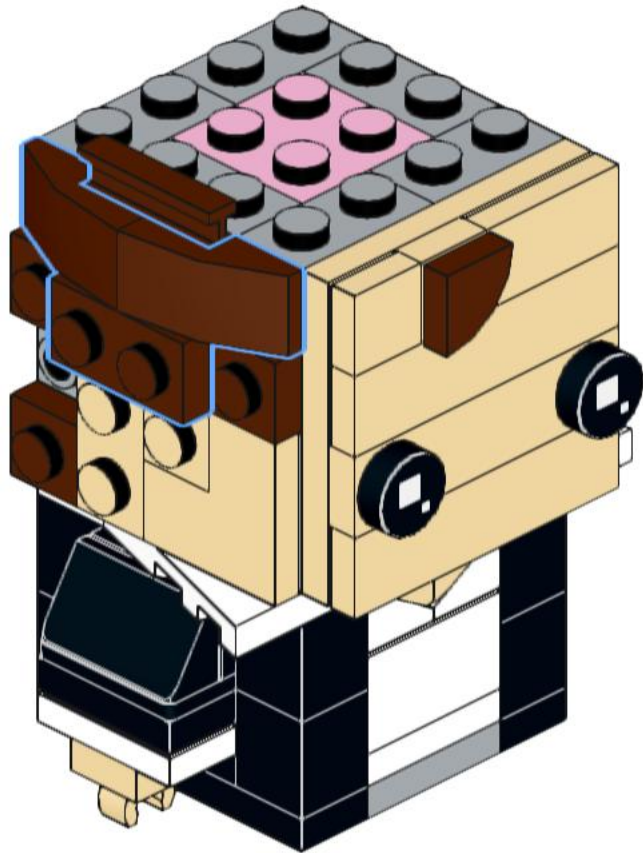
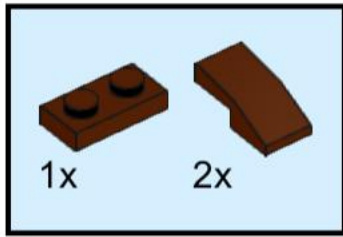

# 25

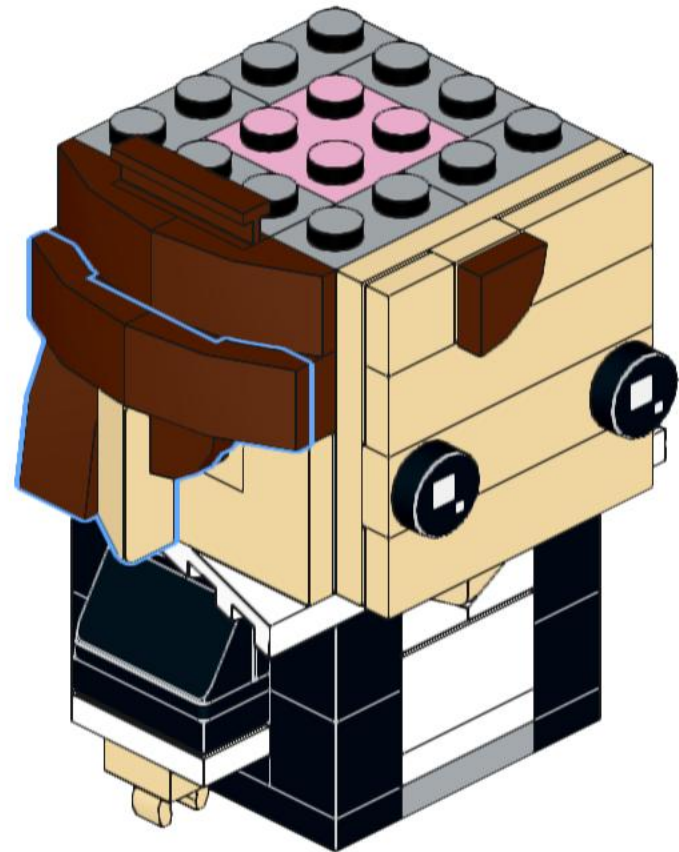
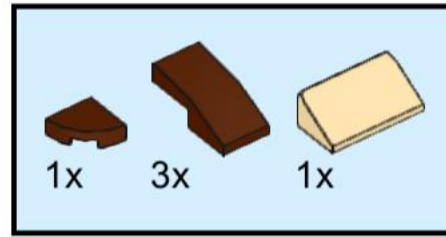

# 26

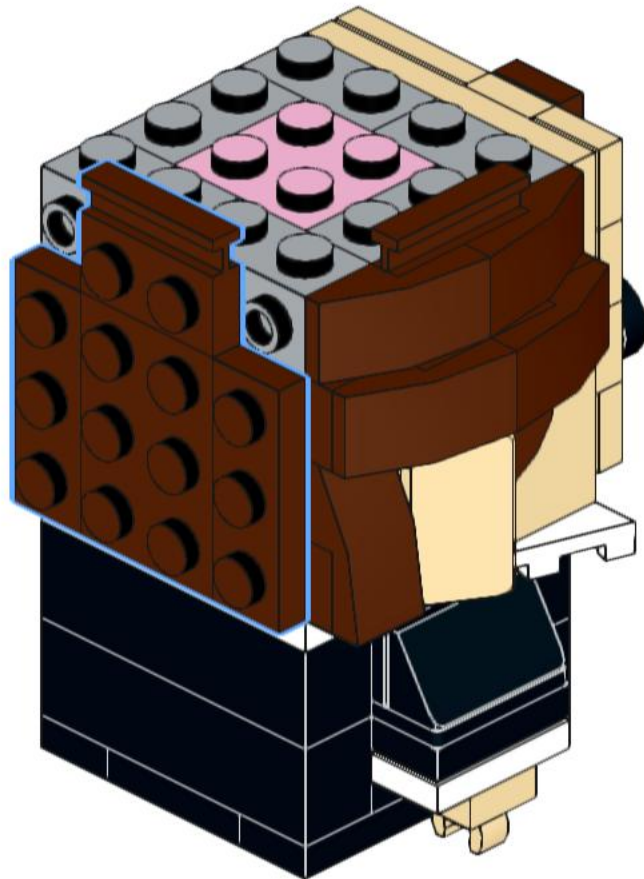
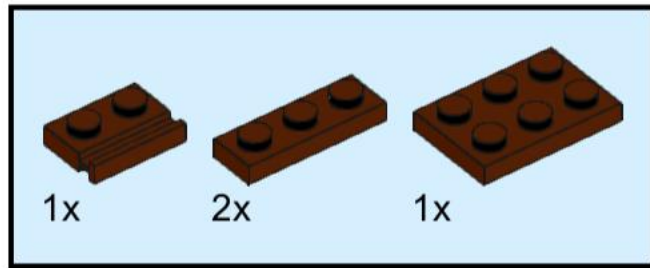

# 27

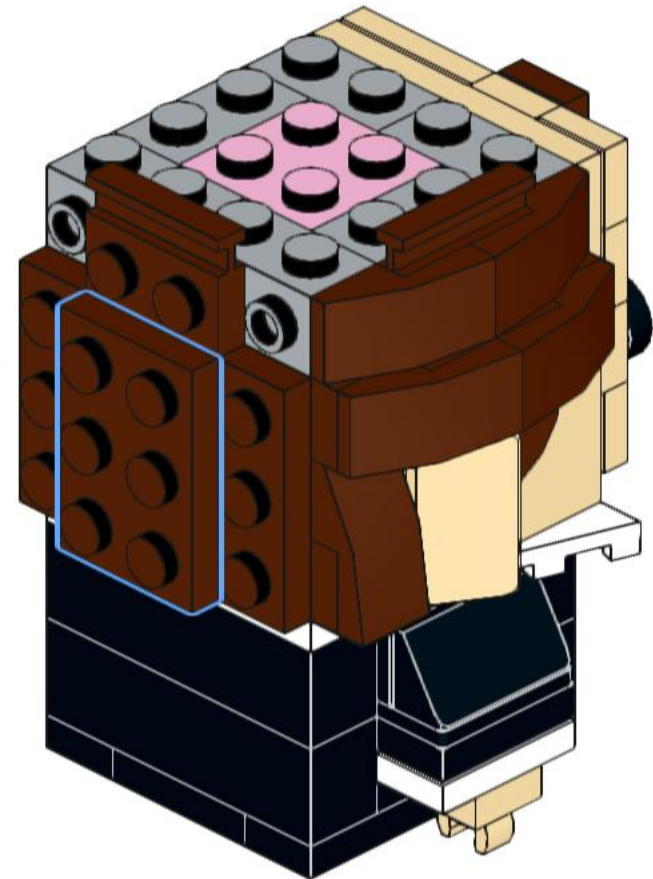
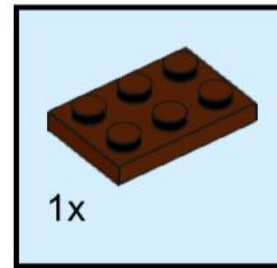

# 28

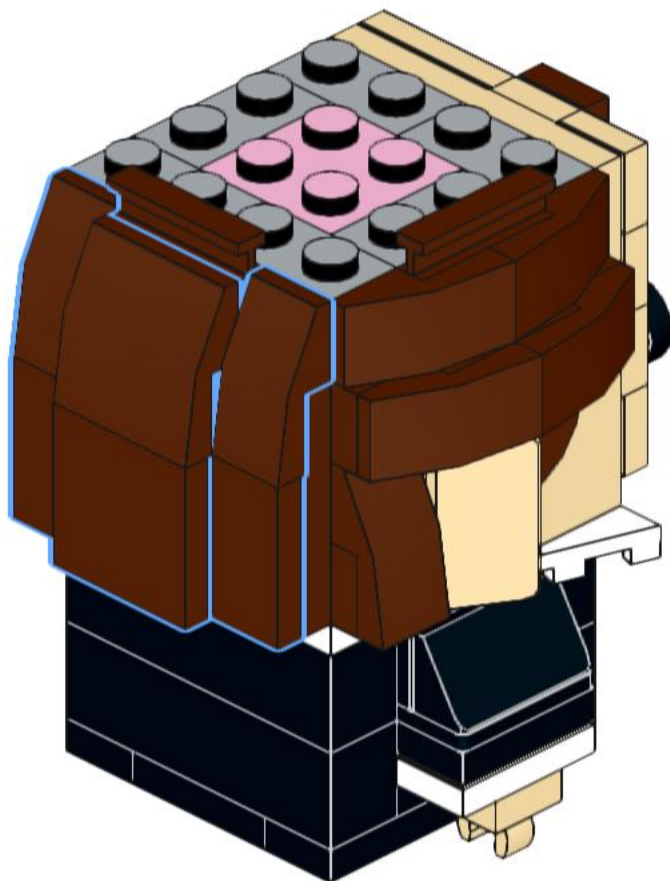
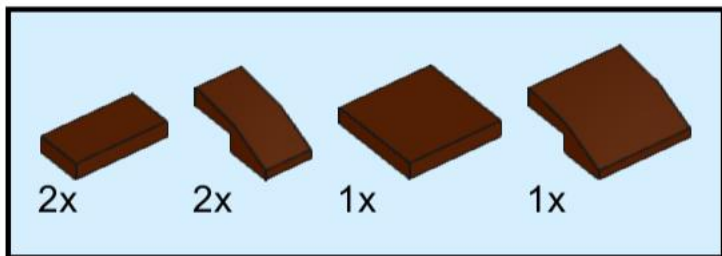

# 29

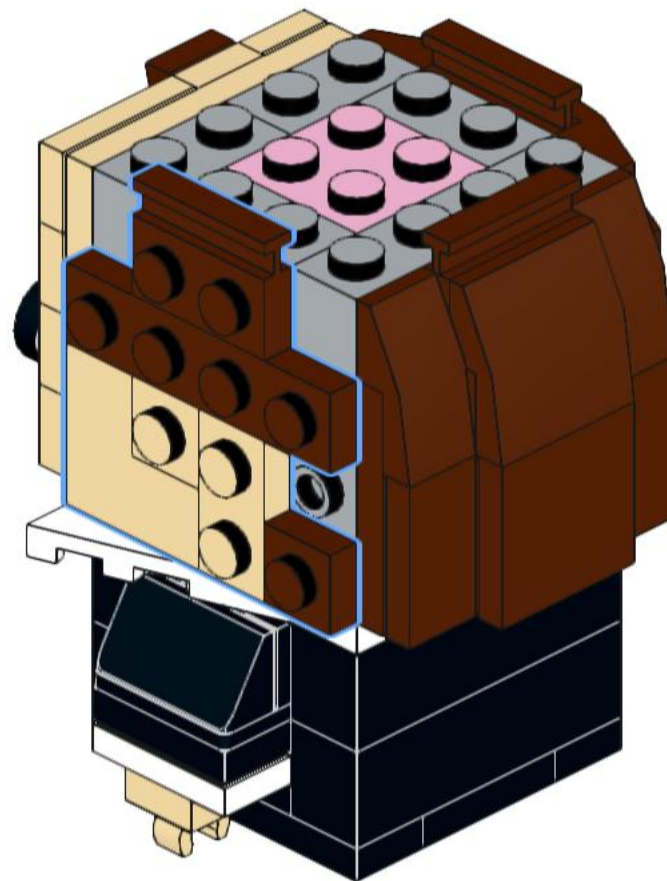
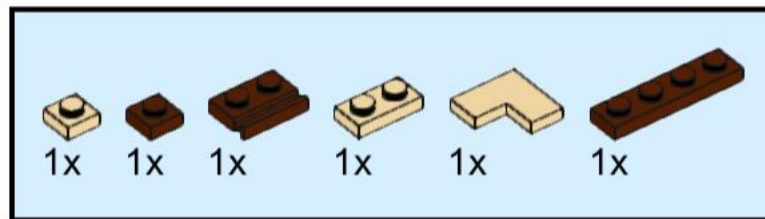

# 30

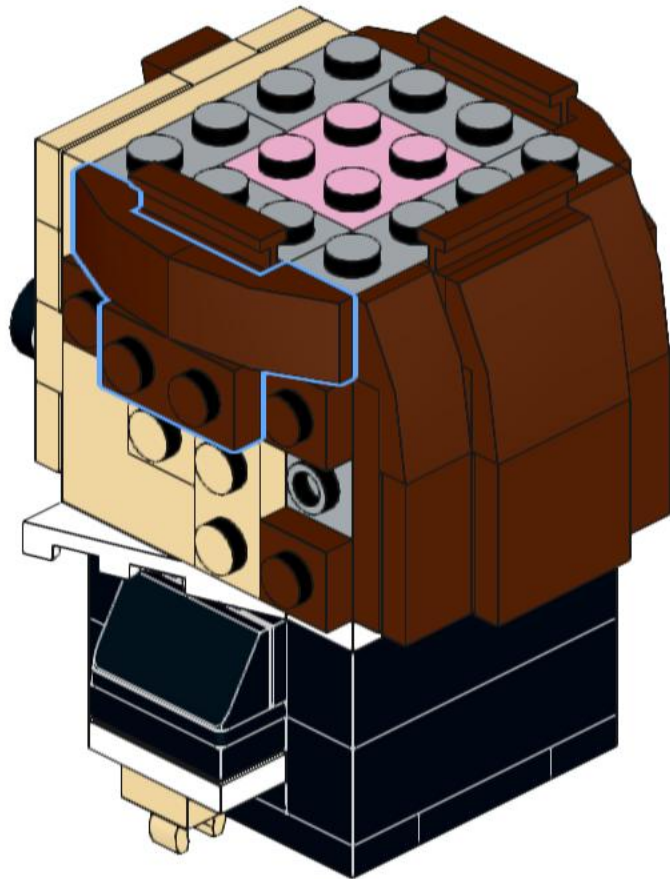
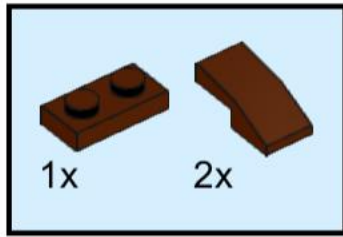

# 31

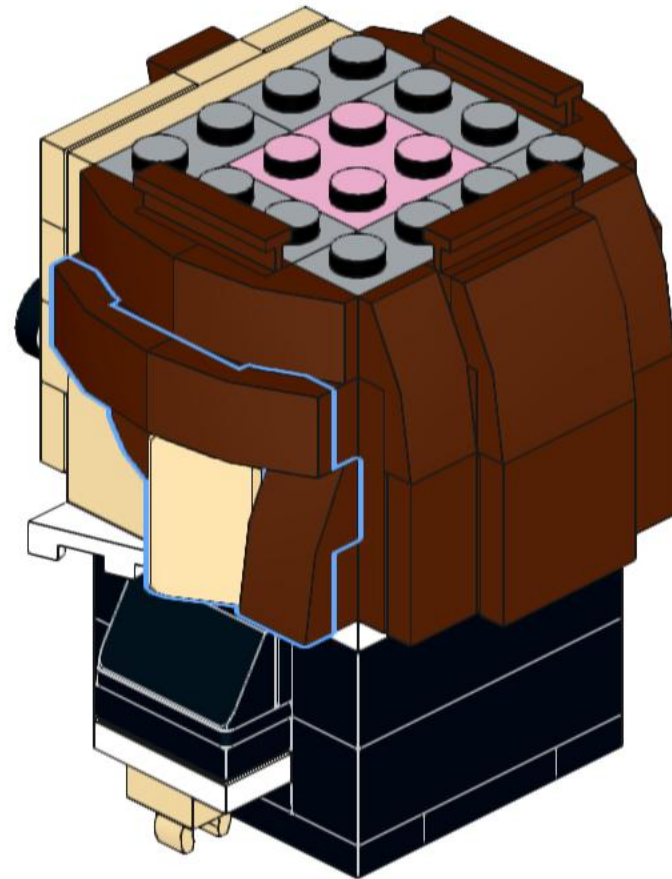
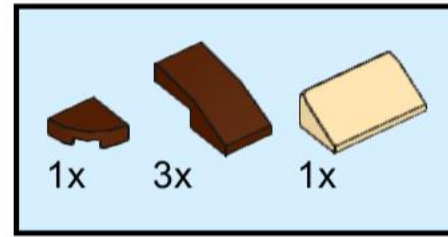



# 32

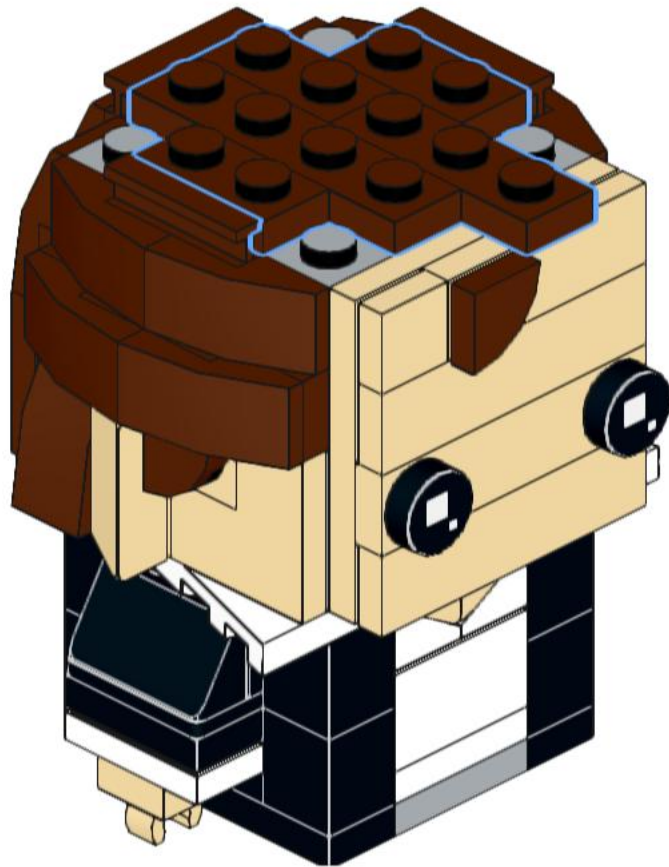
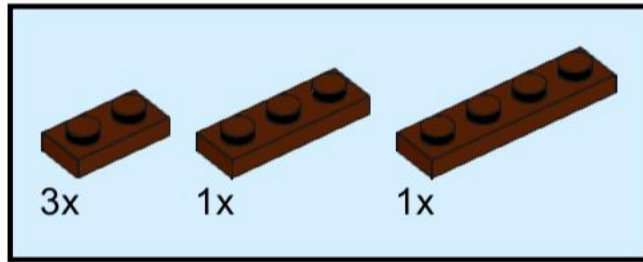

# 33

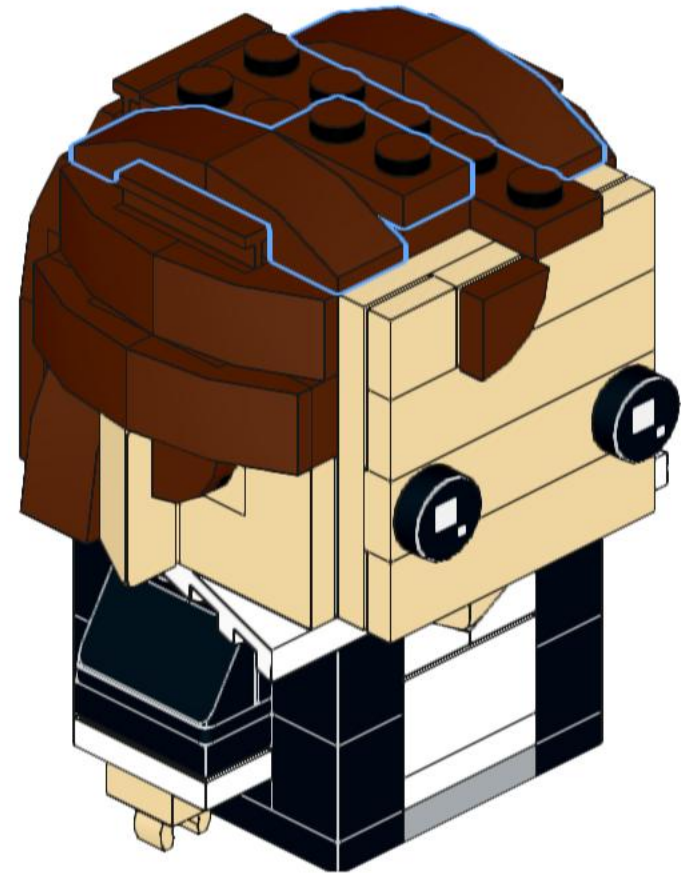
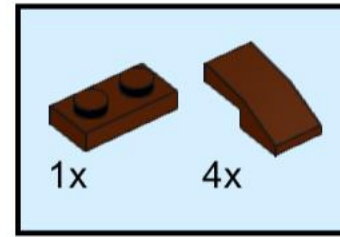

# 34

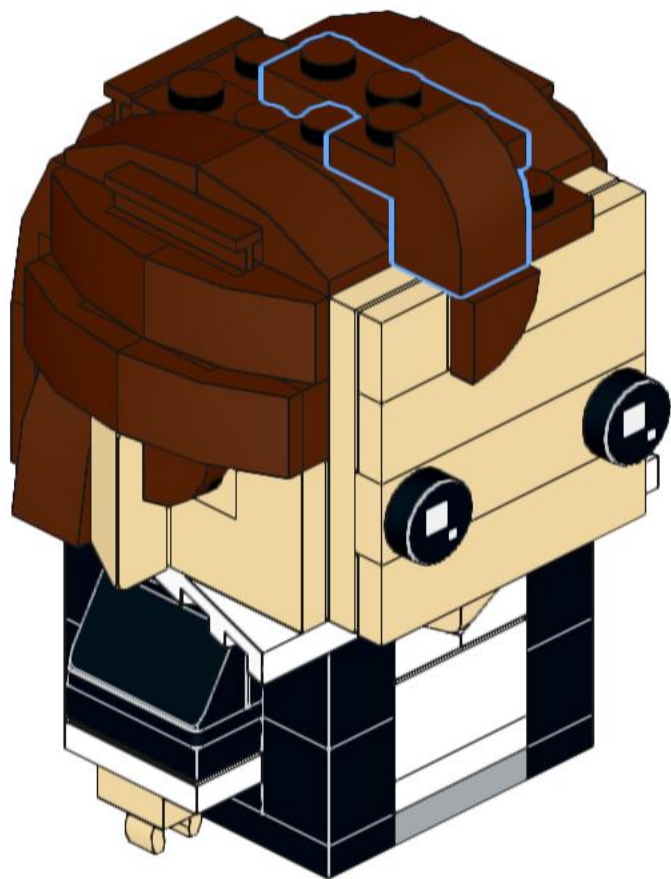
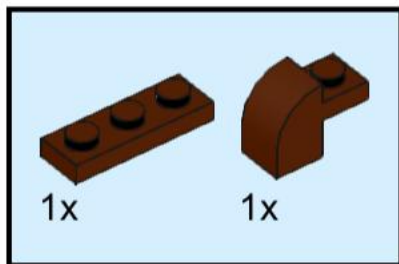

# 35

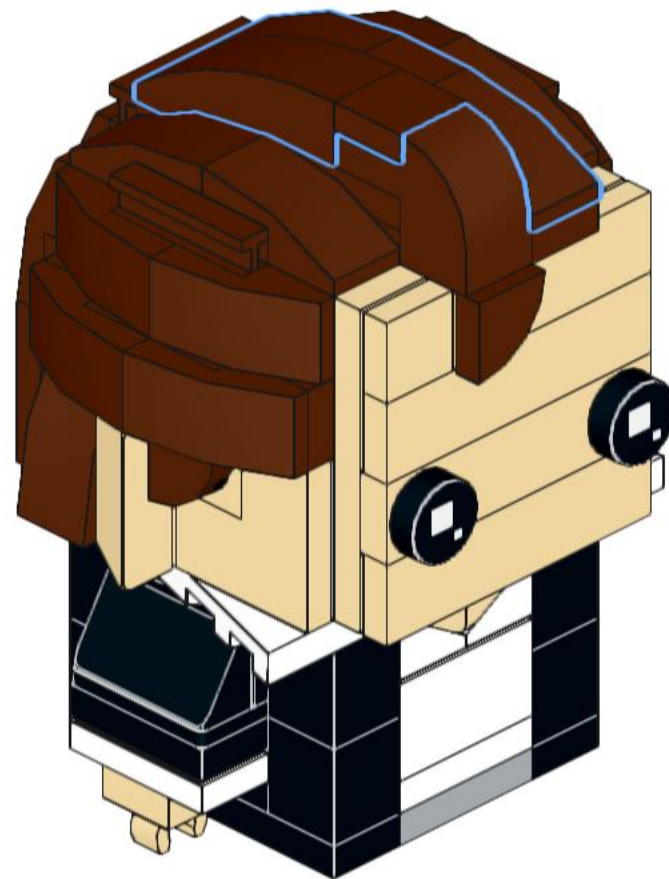
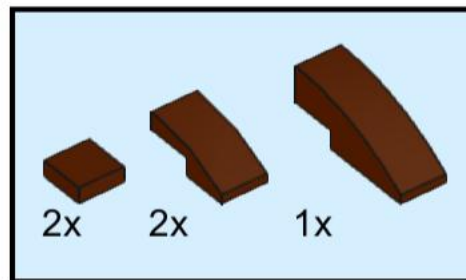

36

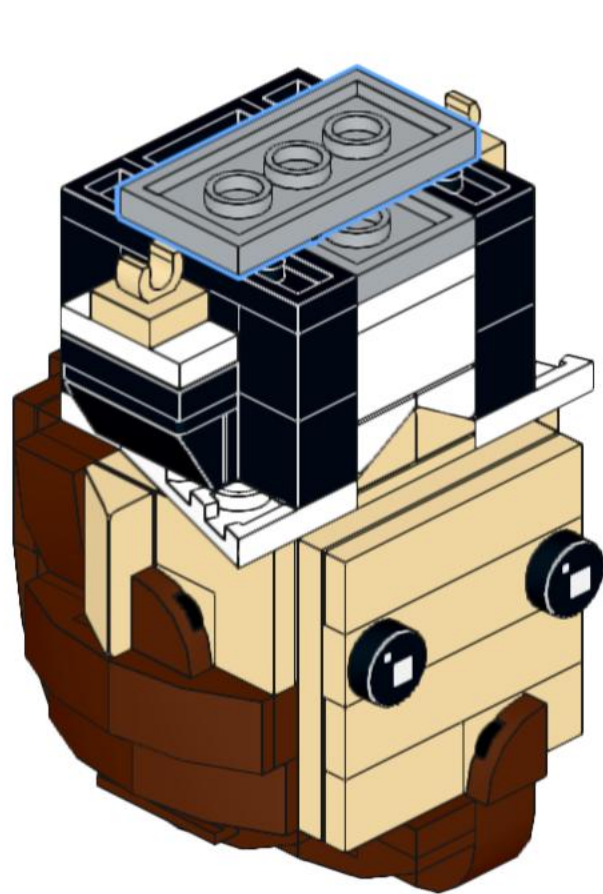
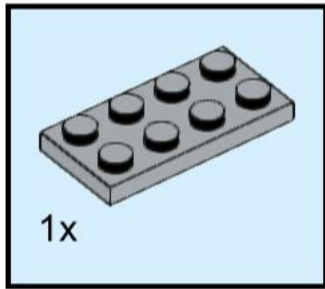

37

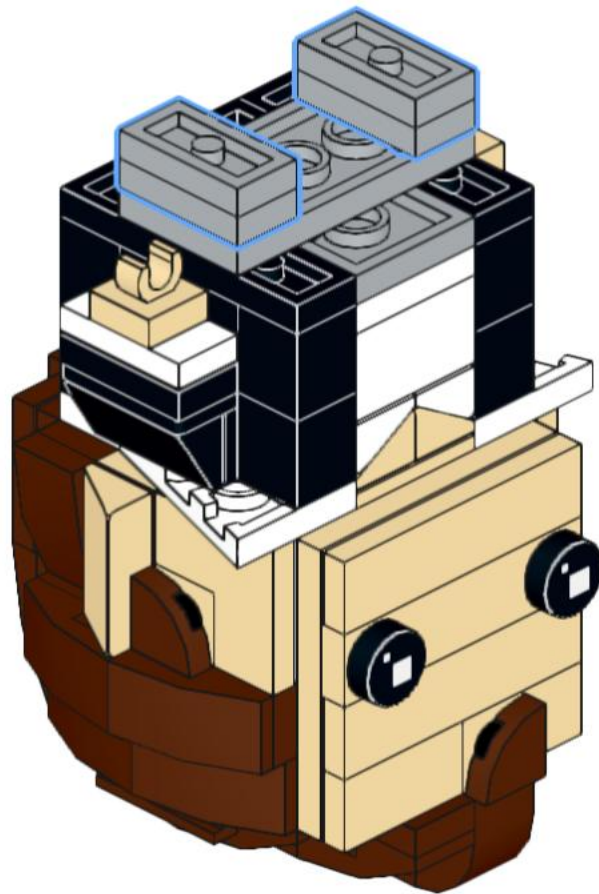
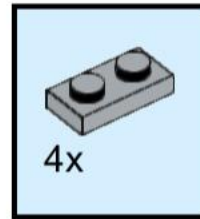

38

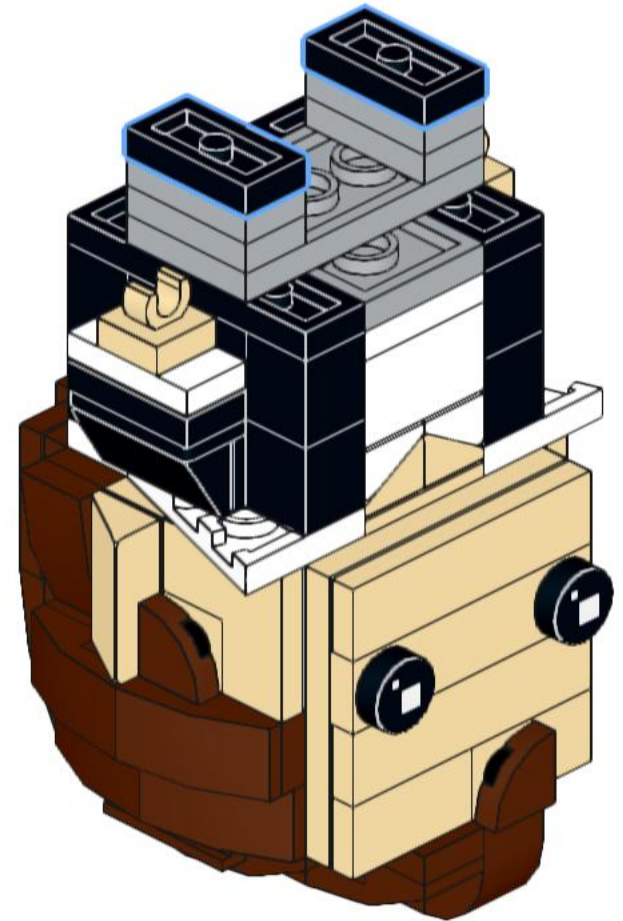
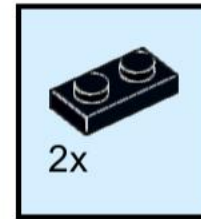

# 39

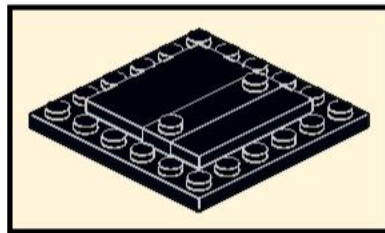
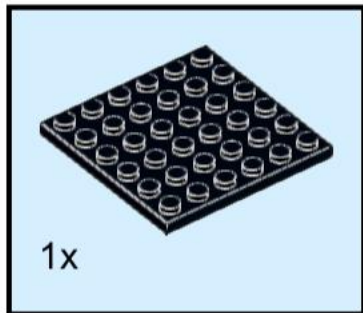

# 40

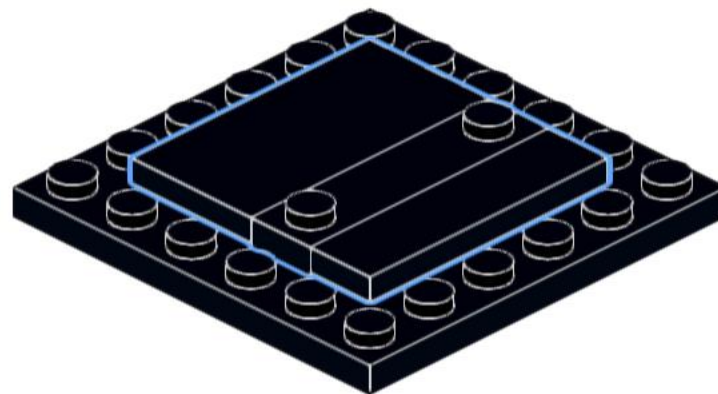
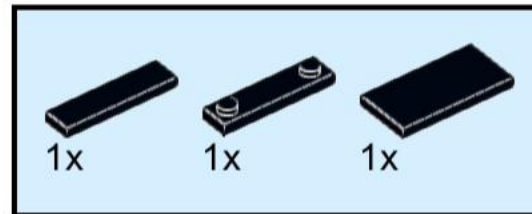

41

