

ADA HEADZ



CHARLES



adaheadz.io/manuals



2x



2x



5x



1x



3x



4x



1x



1x



1x



1x



3x



11x

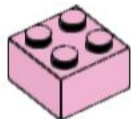

1x



2x



6x



8x



2x



1x



1x



2x



7x



4x



2x



1x



10x



2x



6x



1x



3x



2x



2x



1x



2x



2x



2x



2x



2x

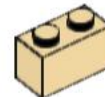

1x



2x

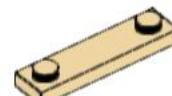

1x

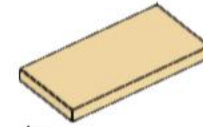

1x

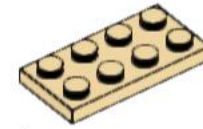

1x



2x

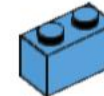

1x



4x



1x



1x



2x

1

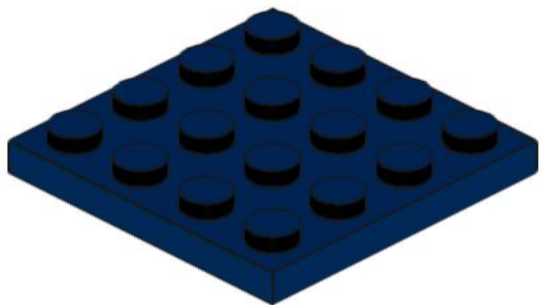
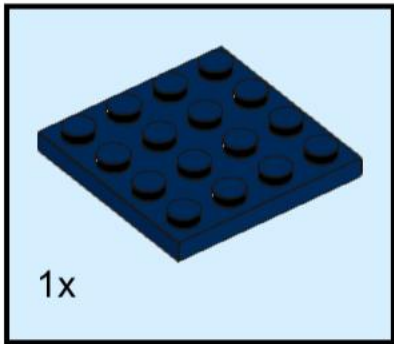

2

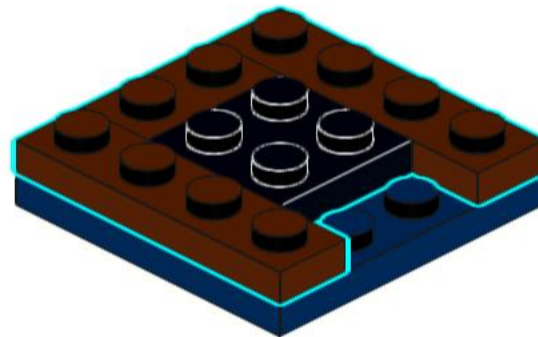
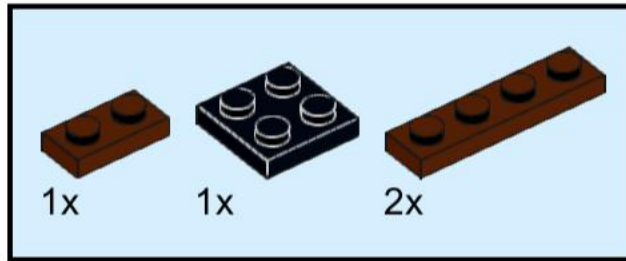

3

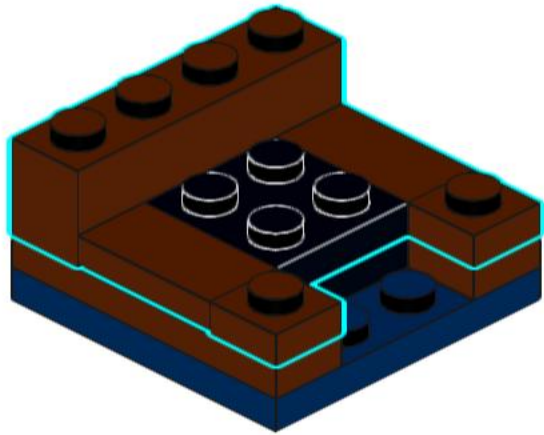
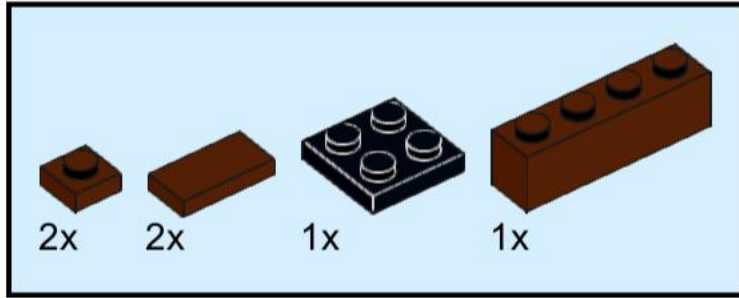

4

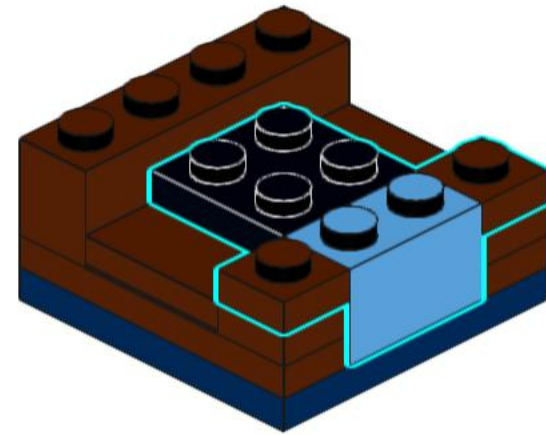
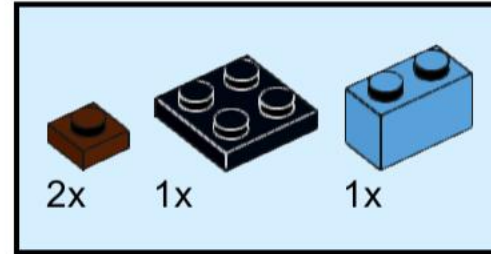

5

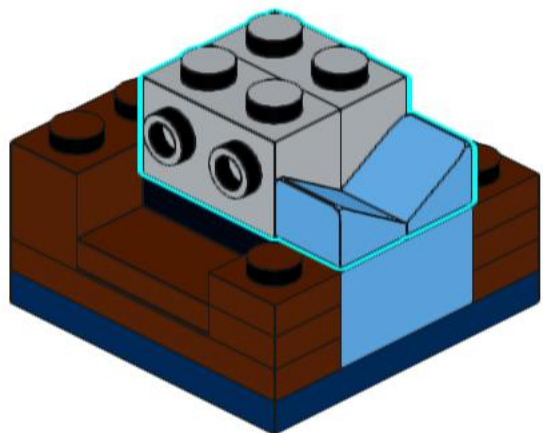
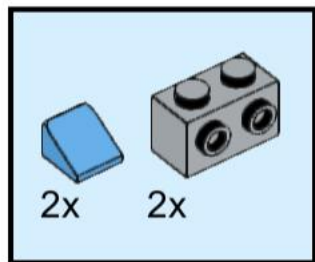

6

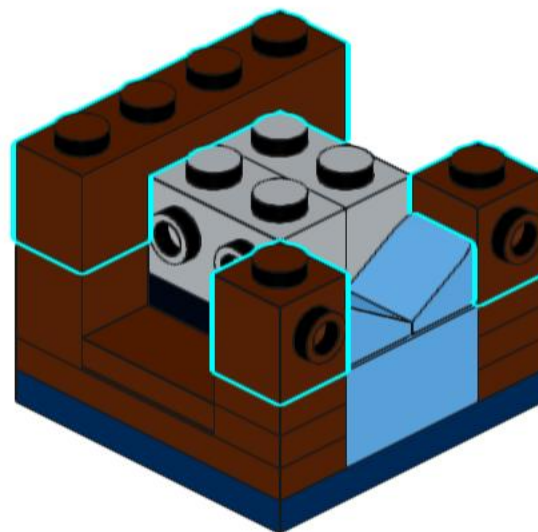
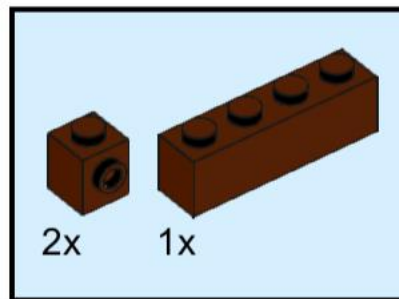

7

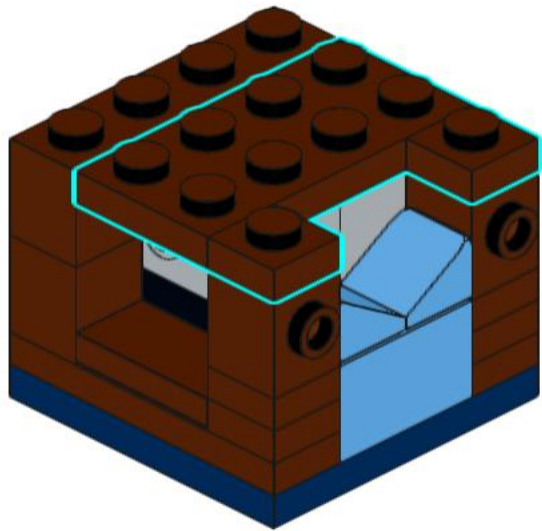
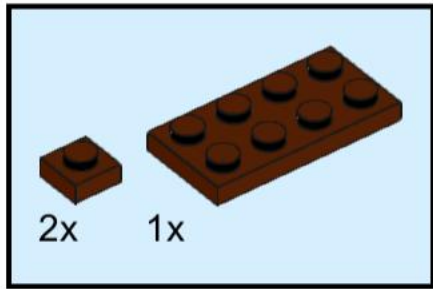

8

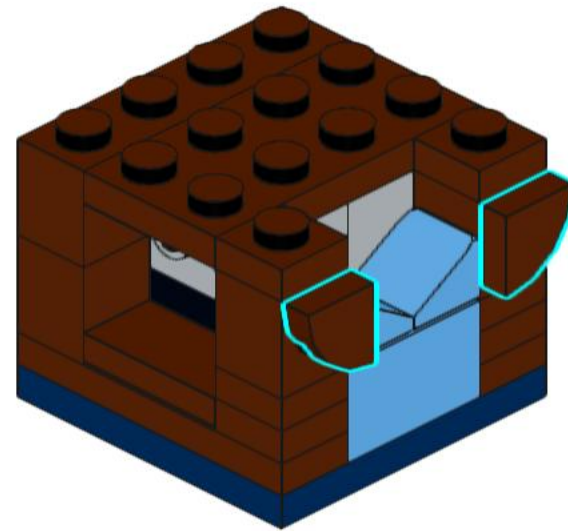

9

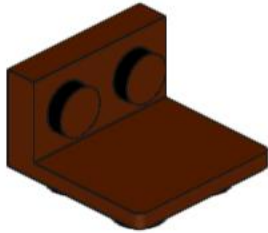
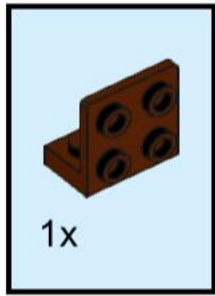

2x

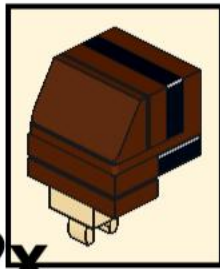

10

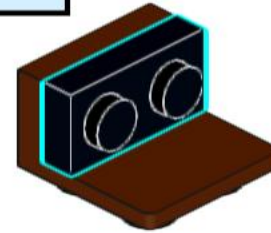
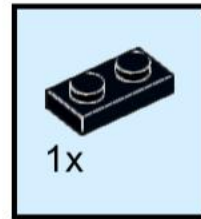

11

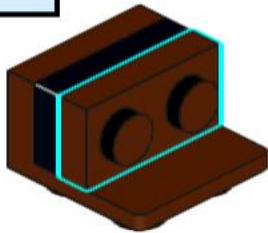
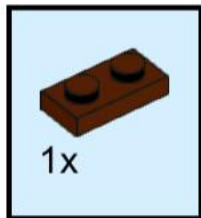

12

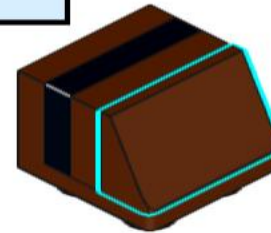
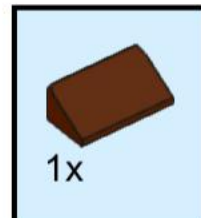

13

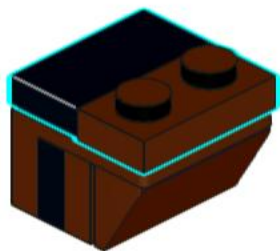
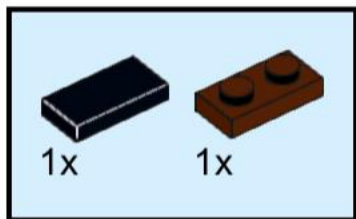

14

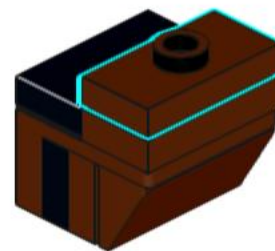
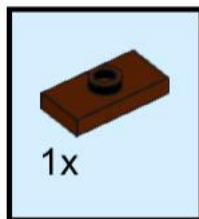

15

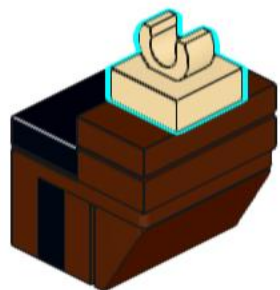
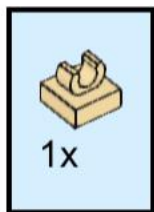

16

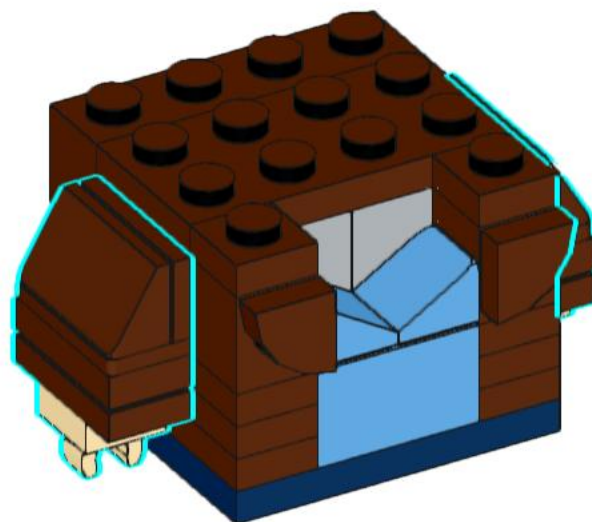

17

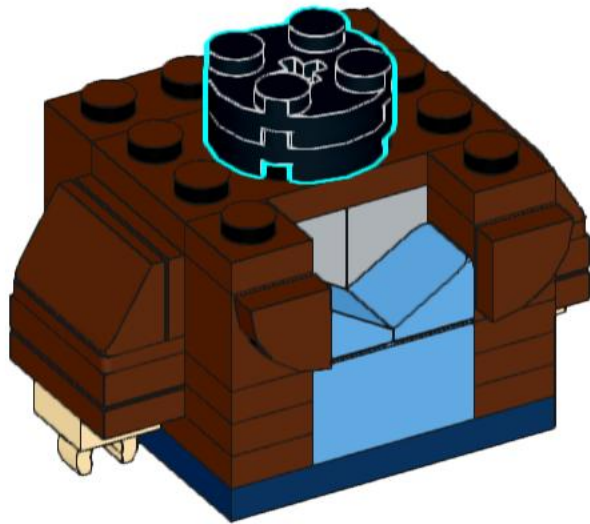
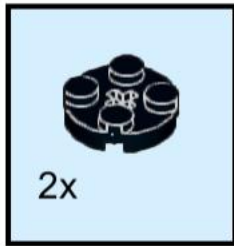

18

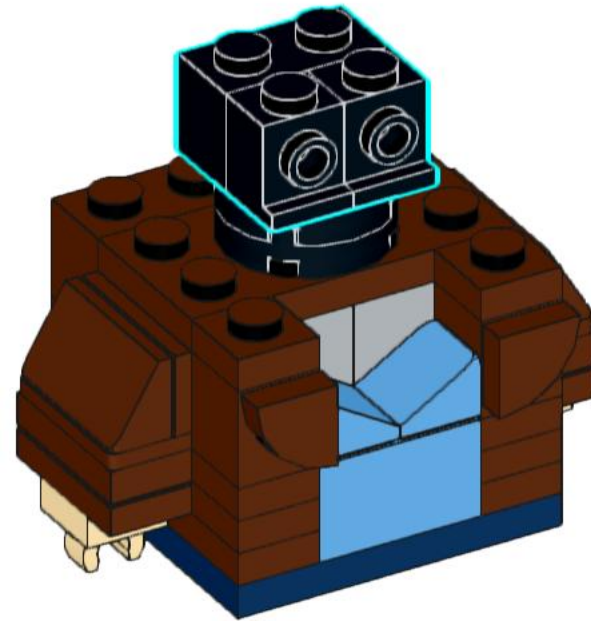
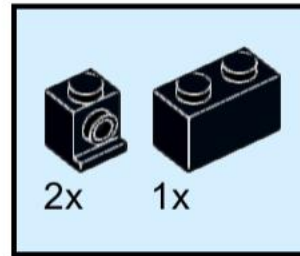

19

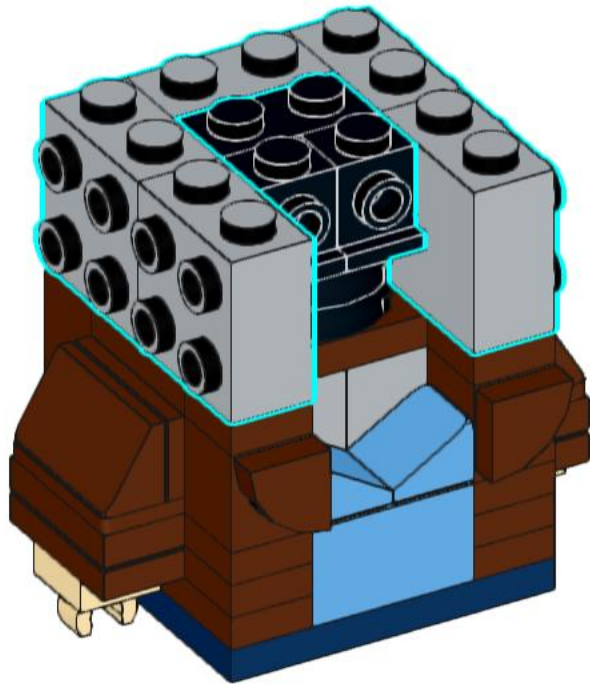
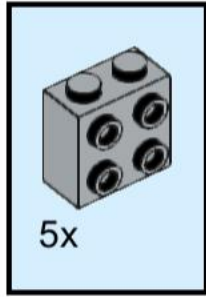

20

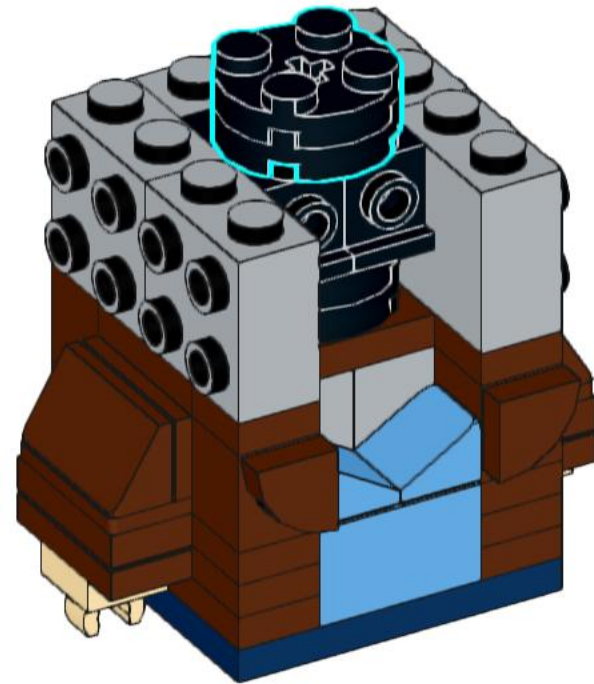

21

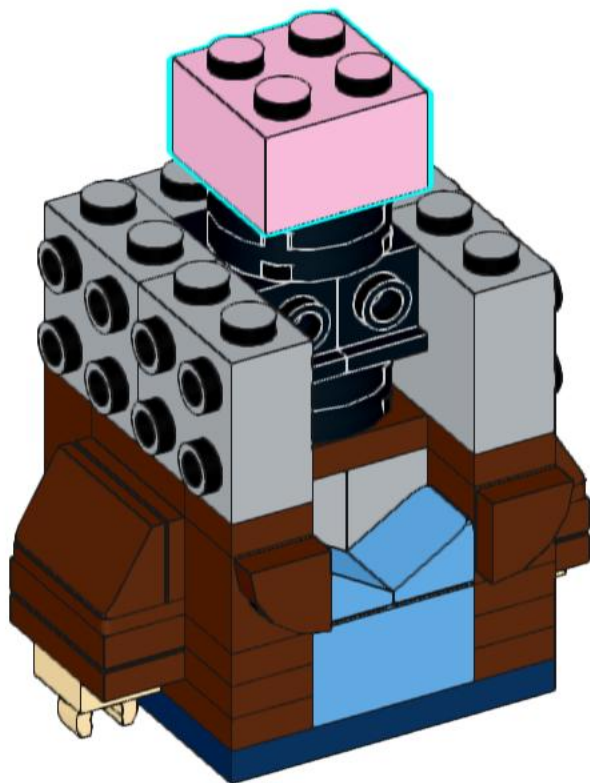
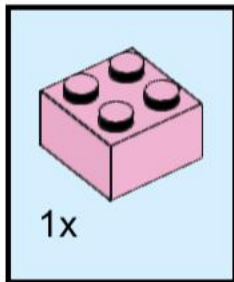

22

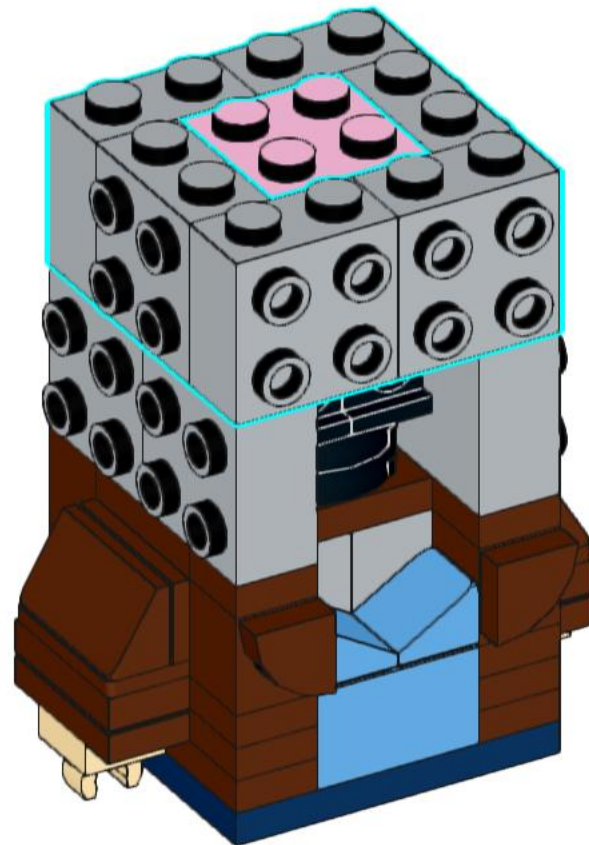
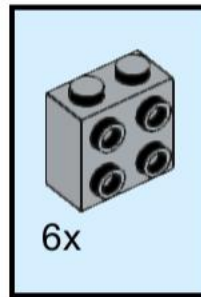

23

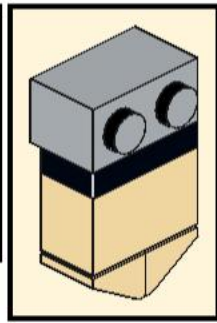
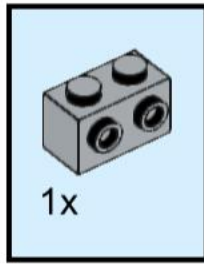

24

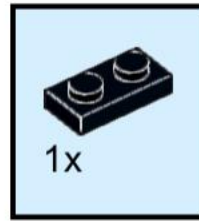

25

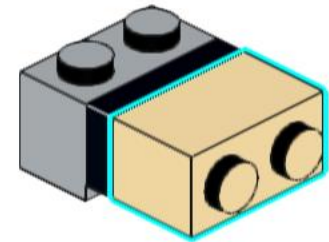
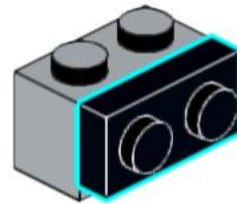
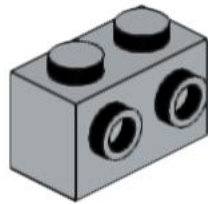
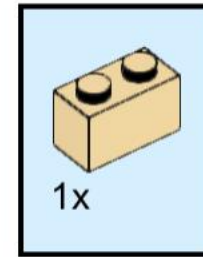

26

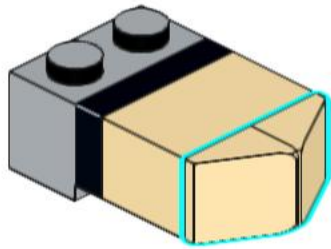
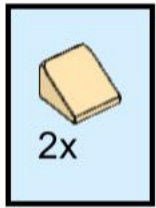

27

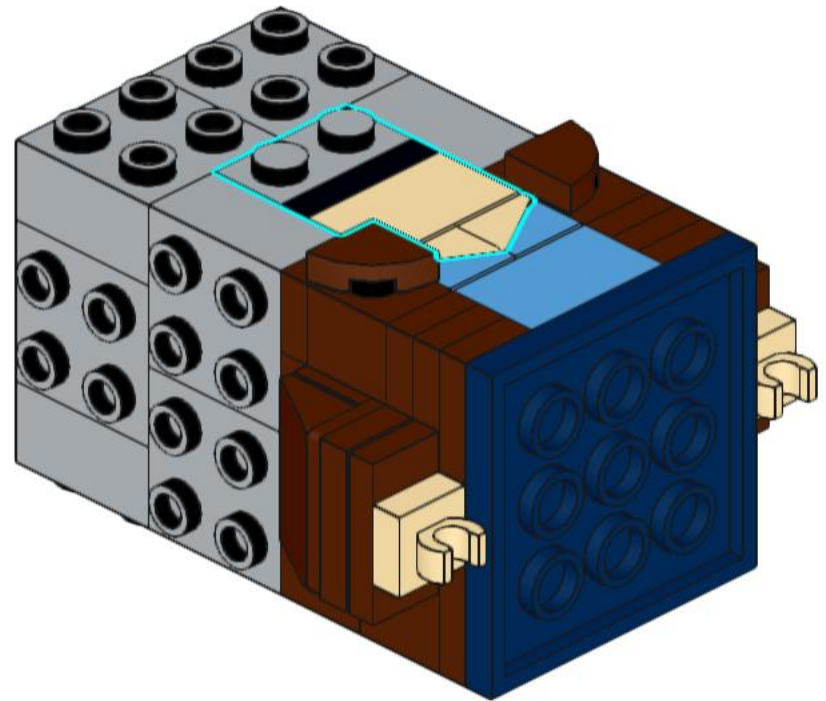

28

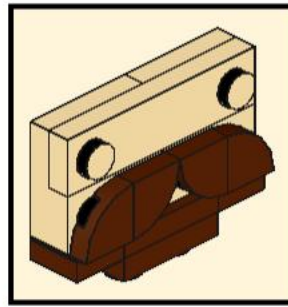
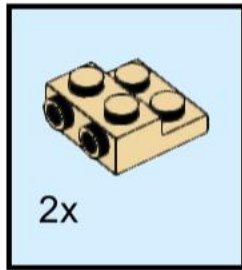

29

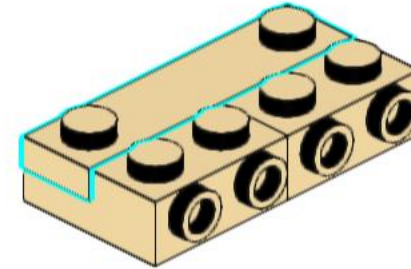
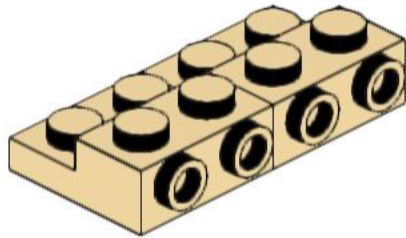
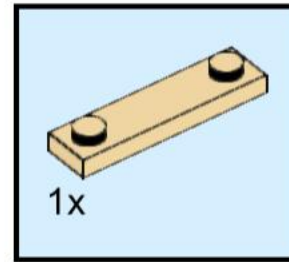

30

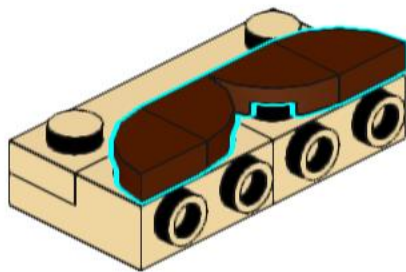
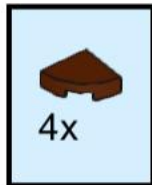

31

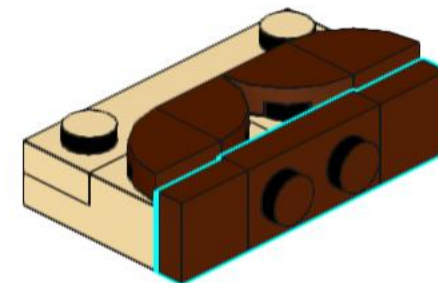
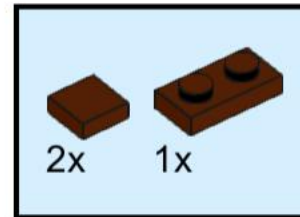

32

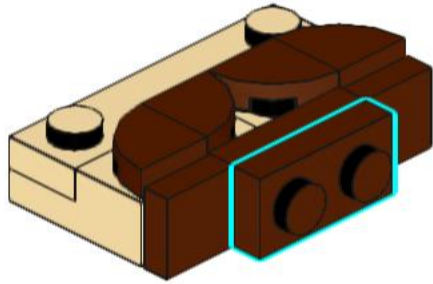
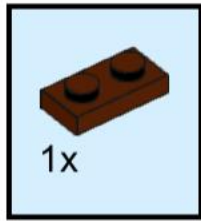

33

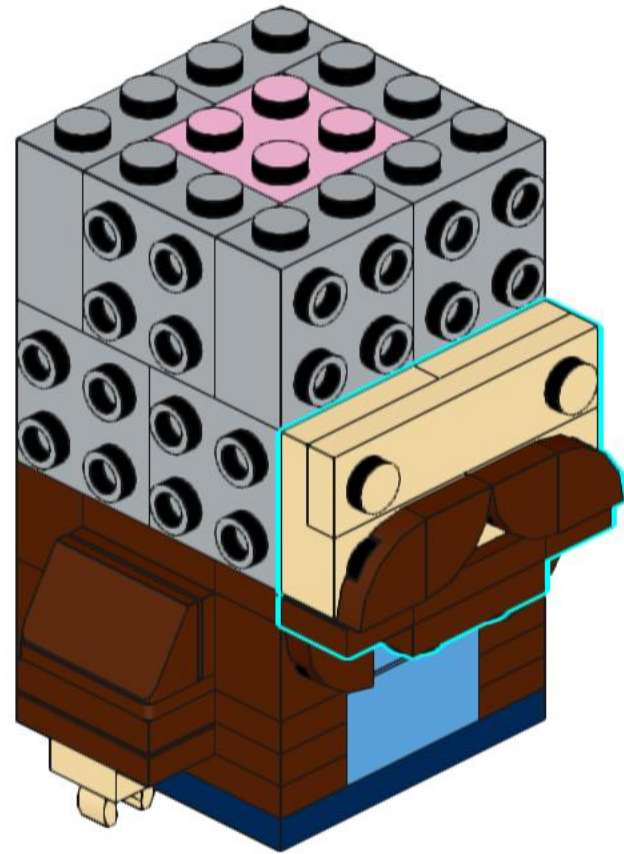

34

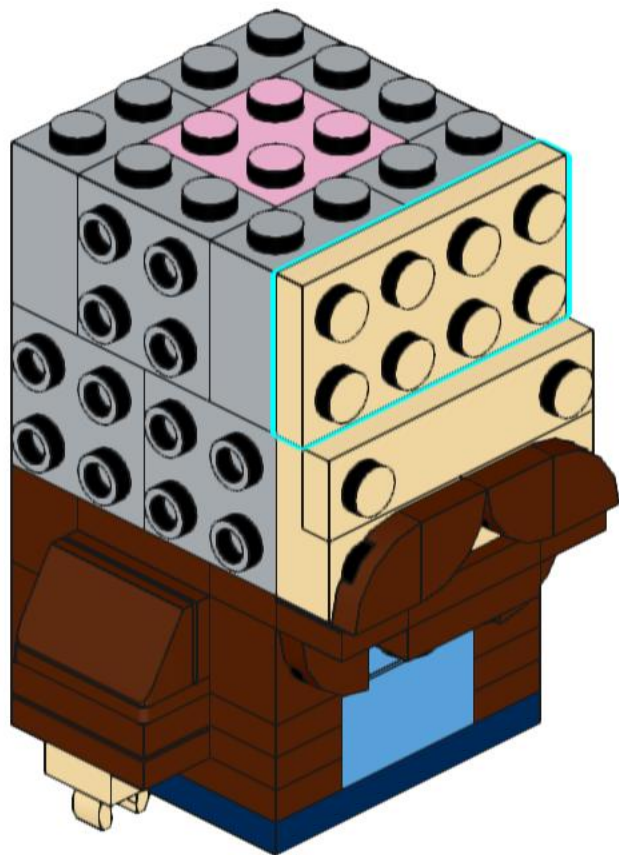
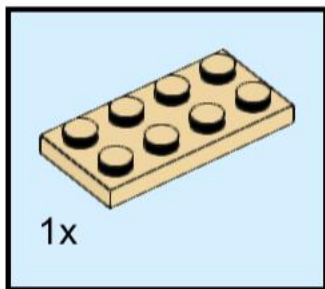

35

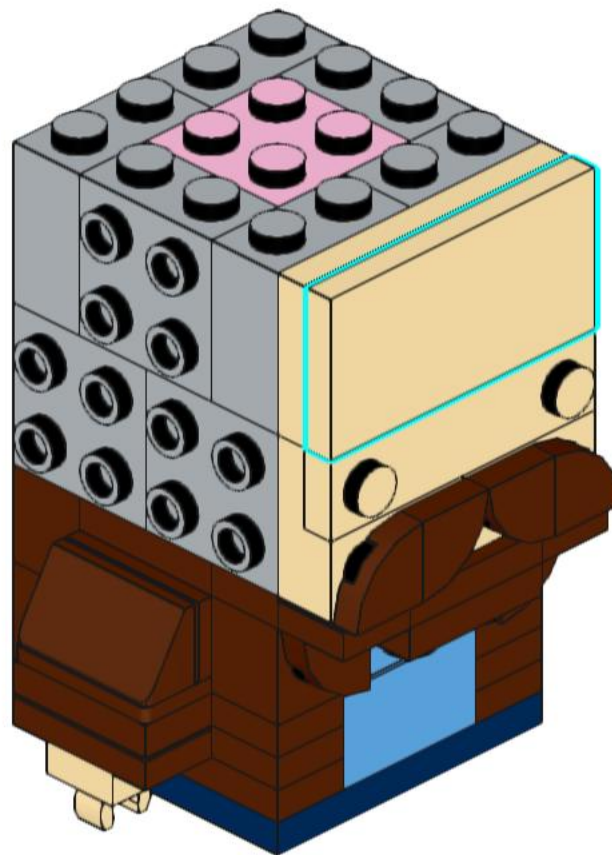
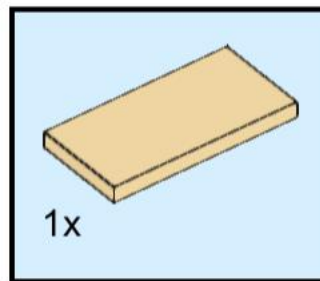

36

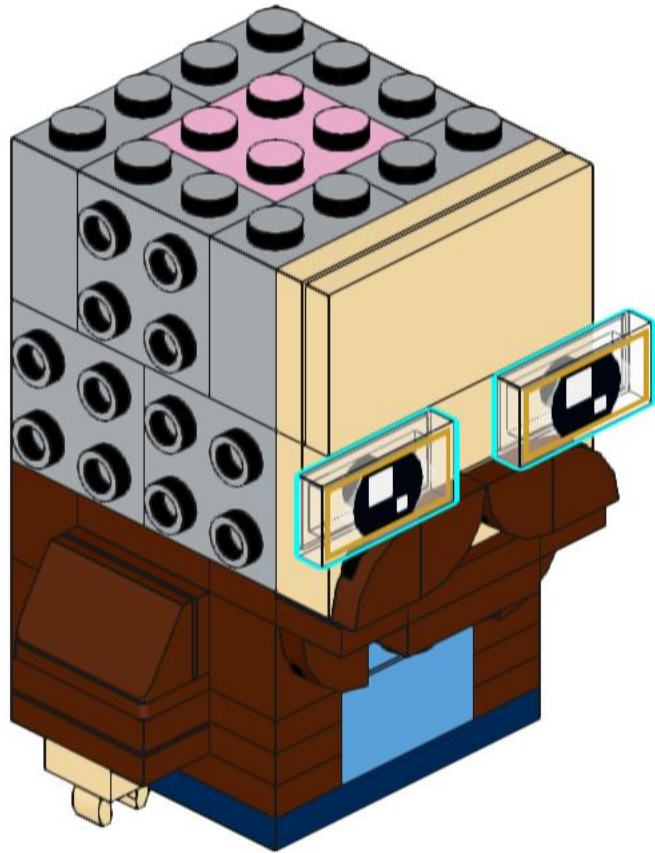
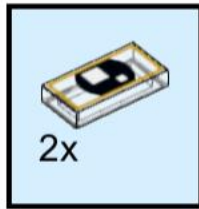

37

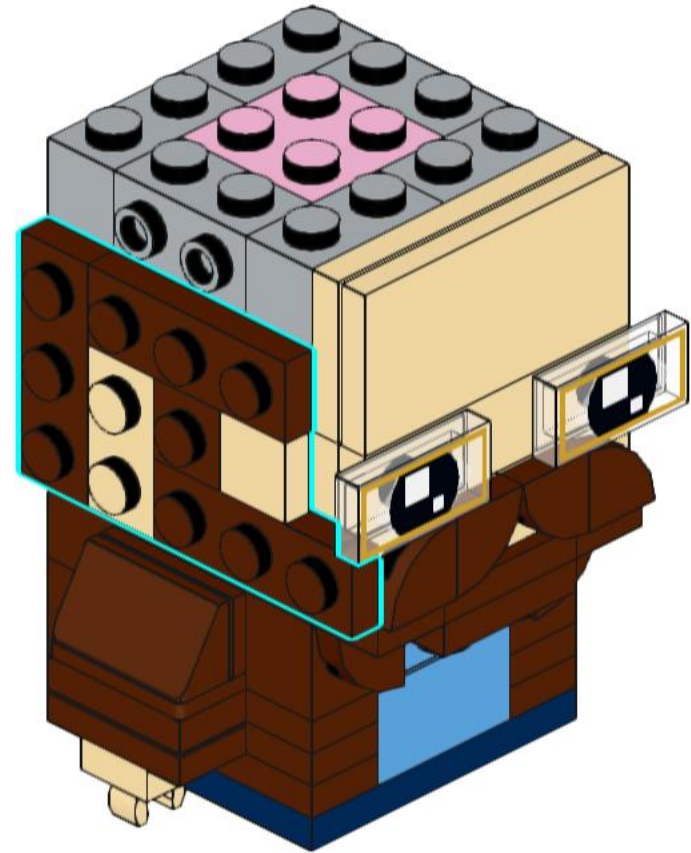
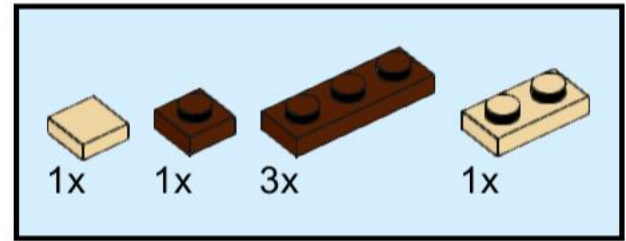

38

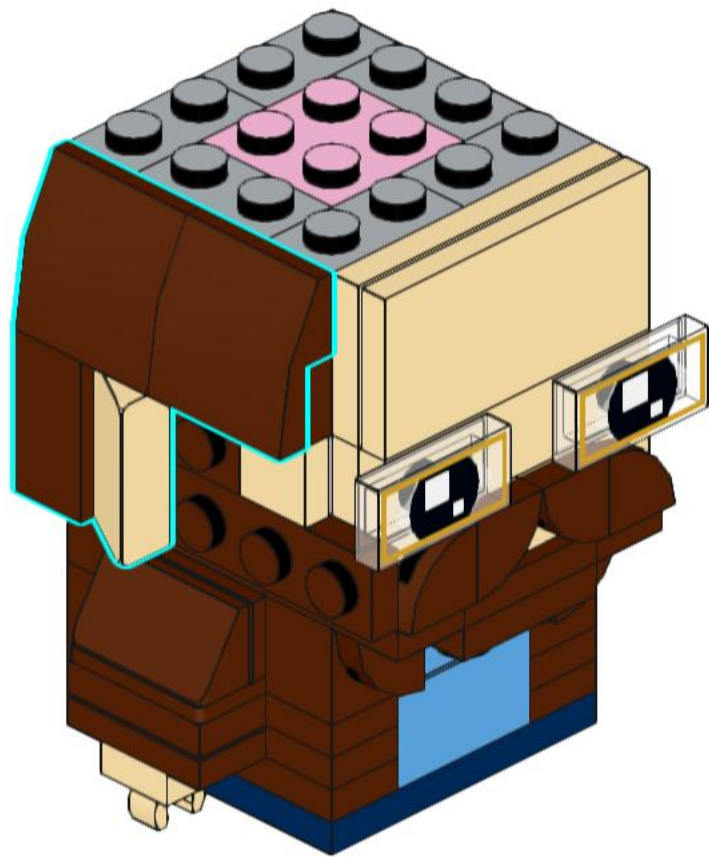
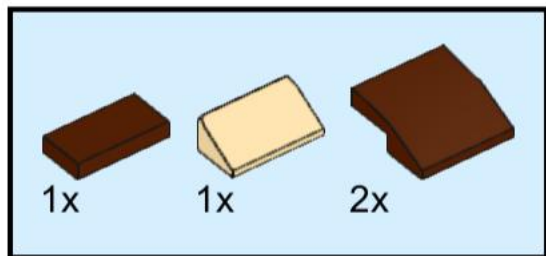

39

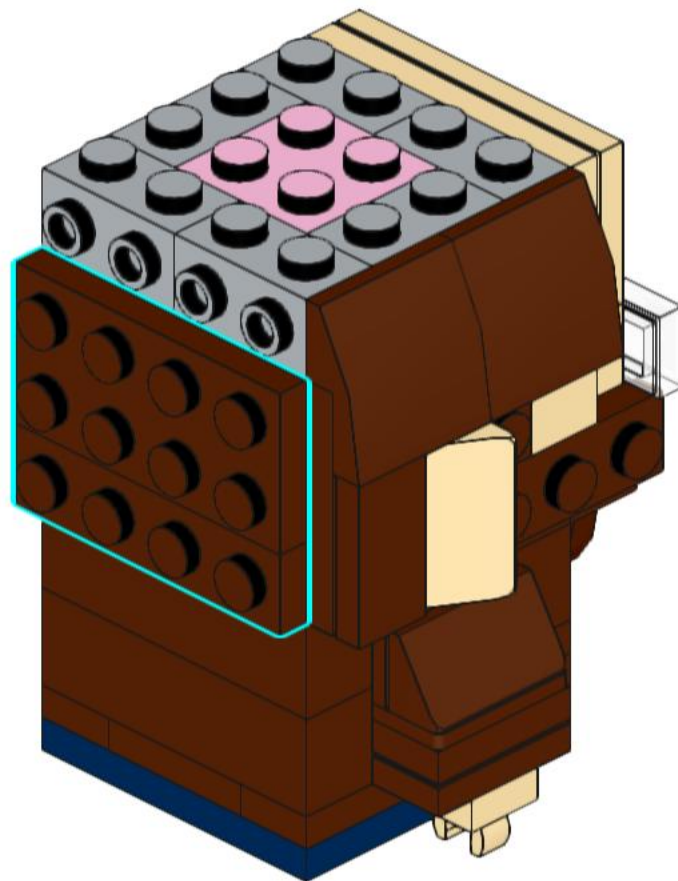
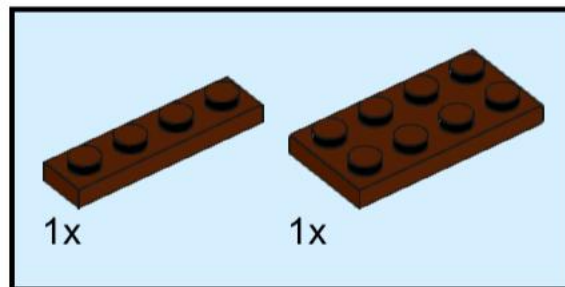

40

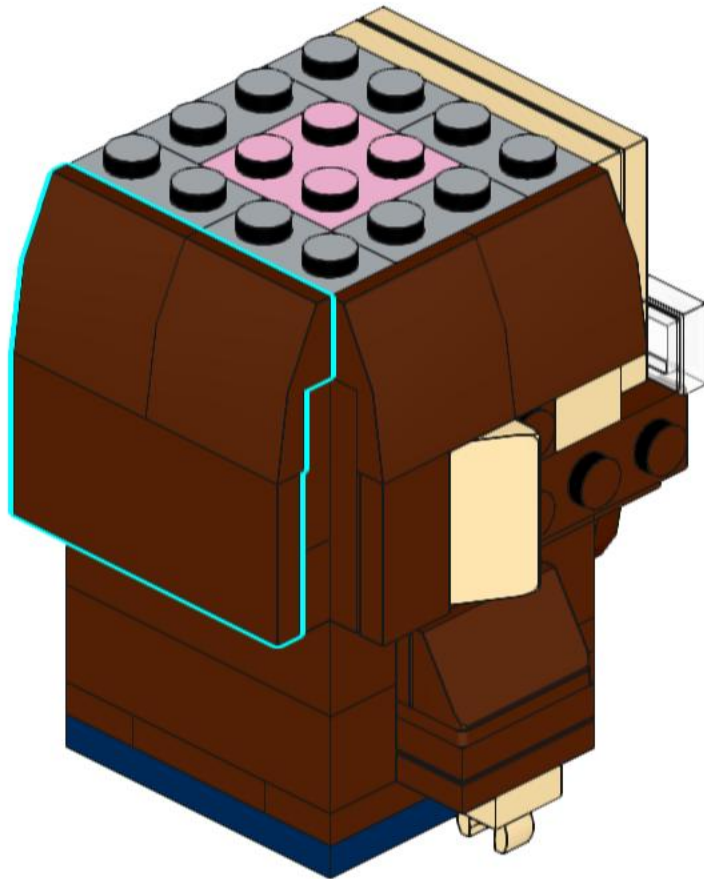
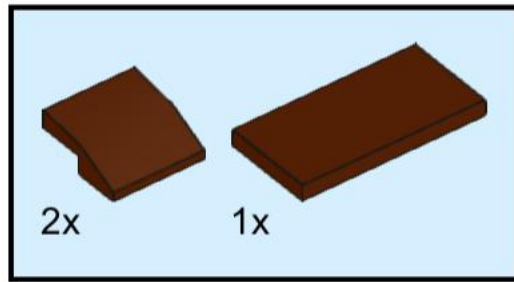

41

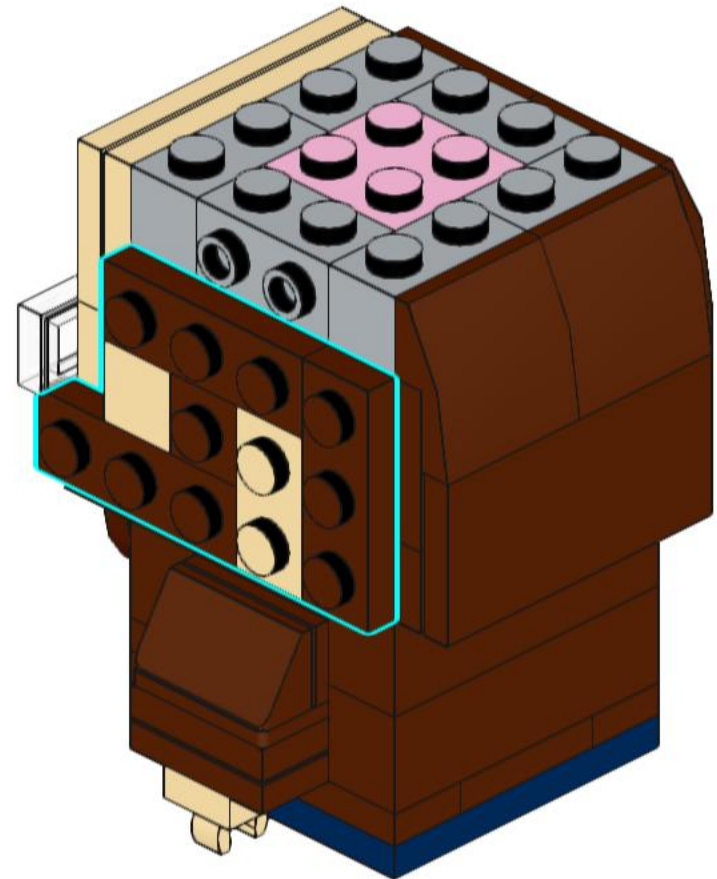
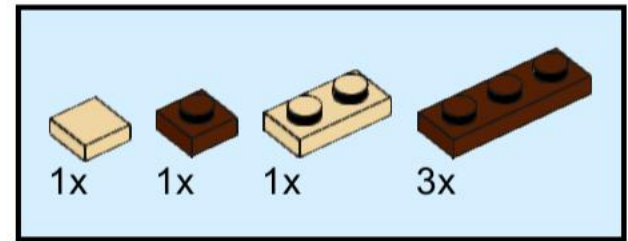

42

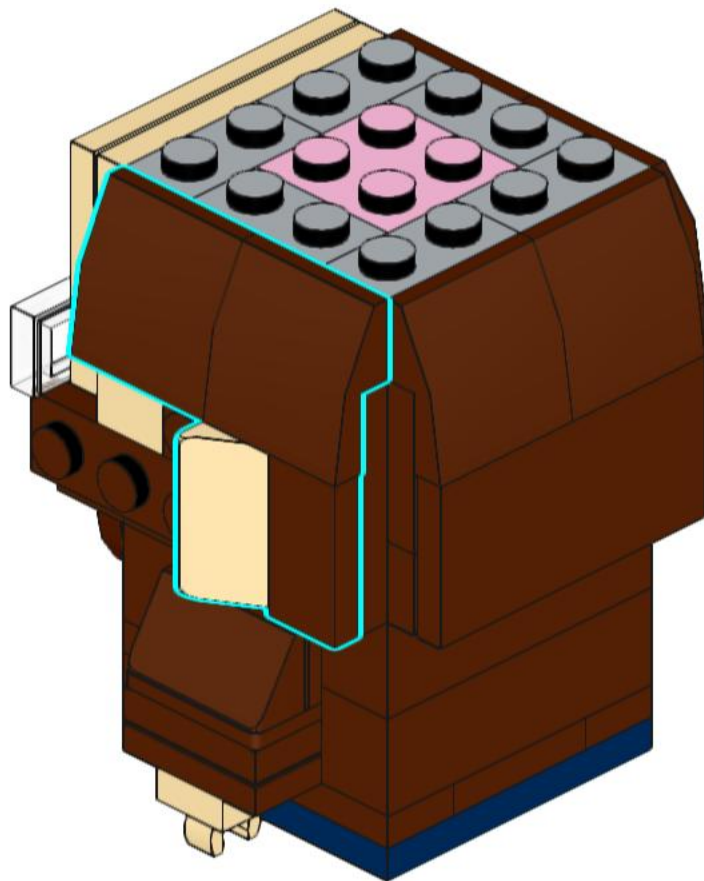
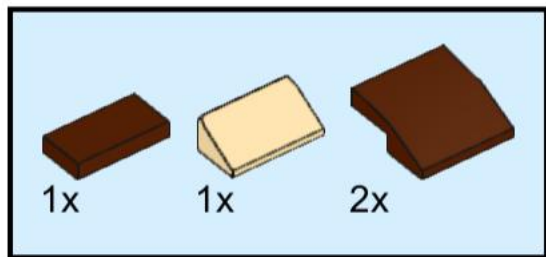

43

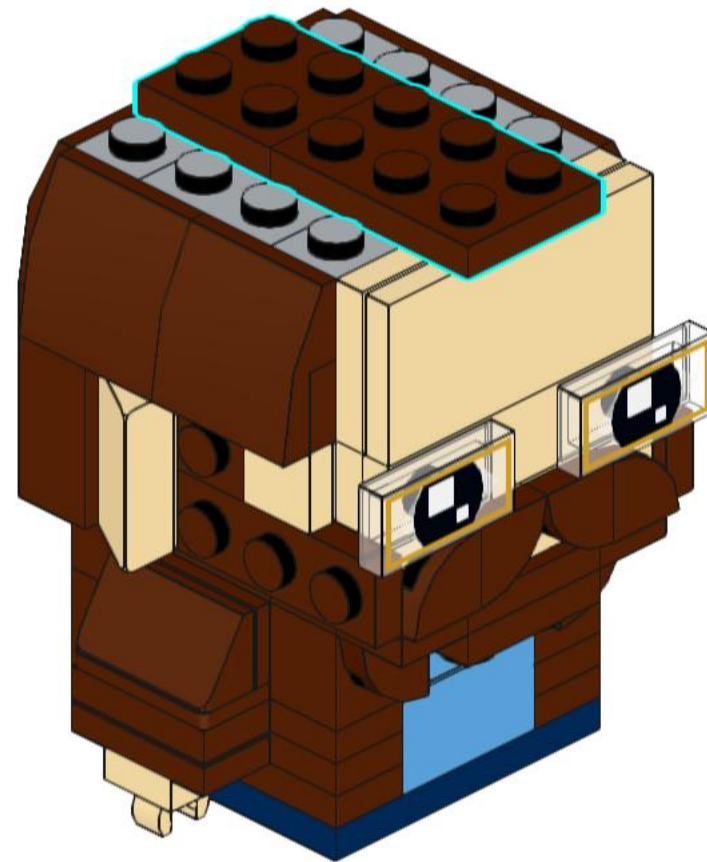
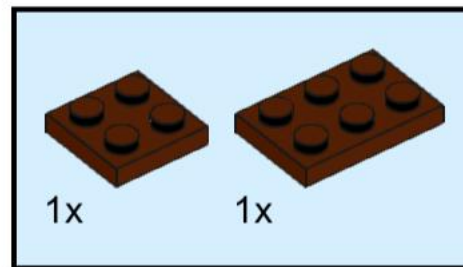

44

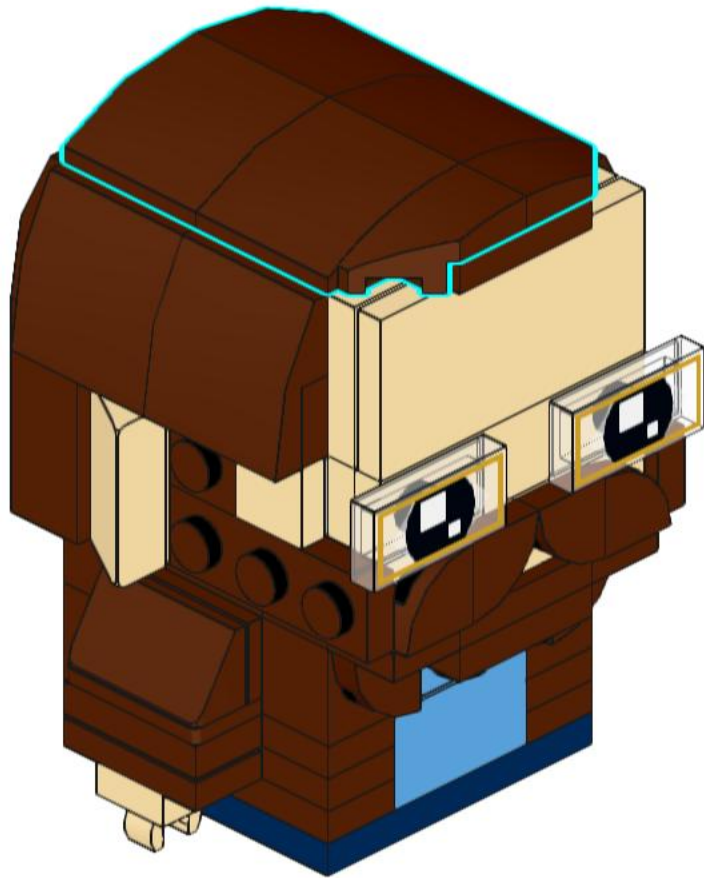
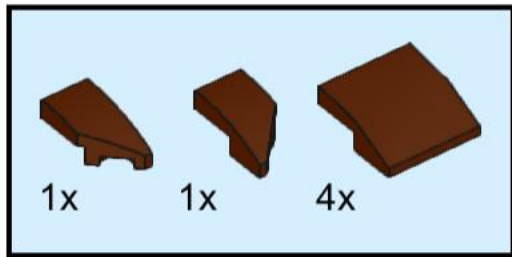

45

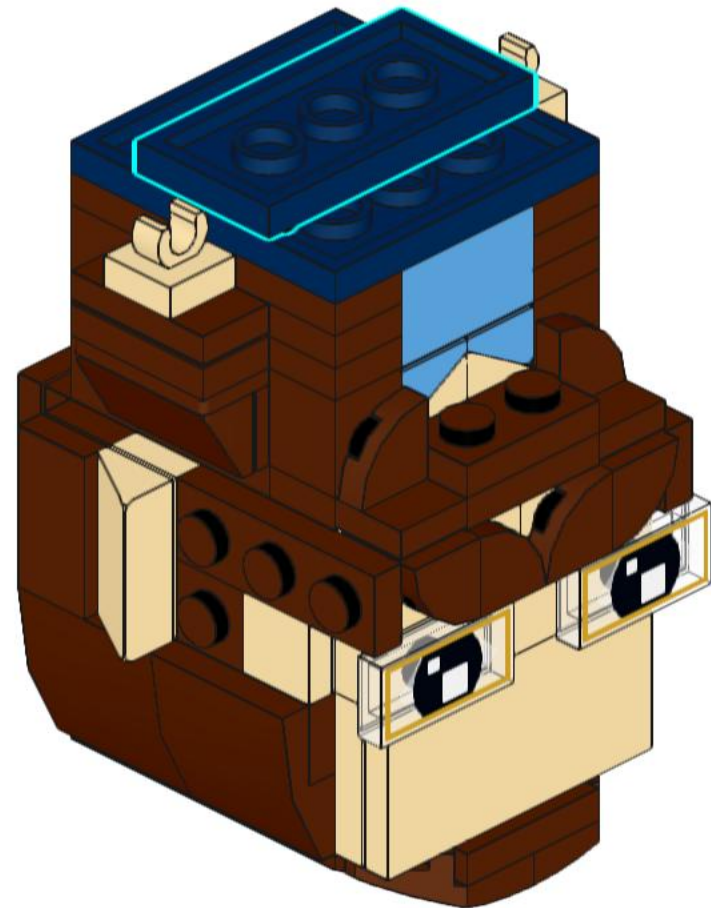
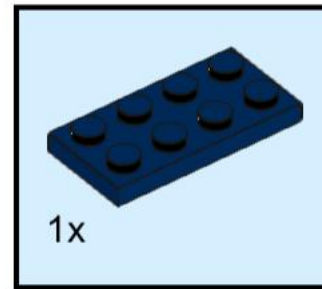

46

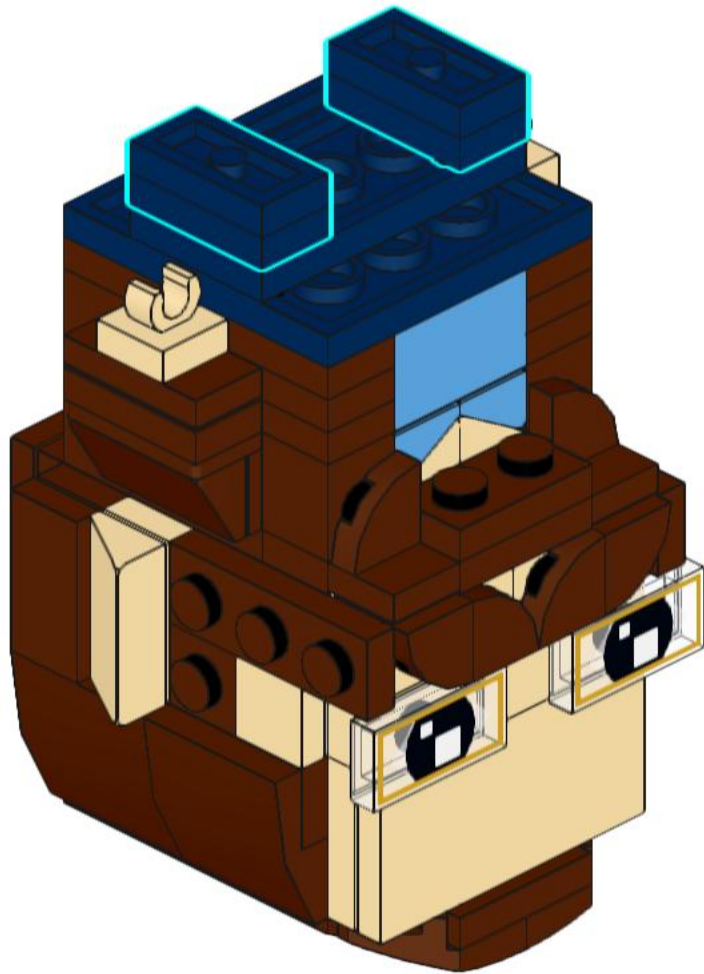
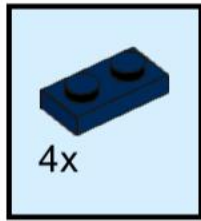

47

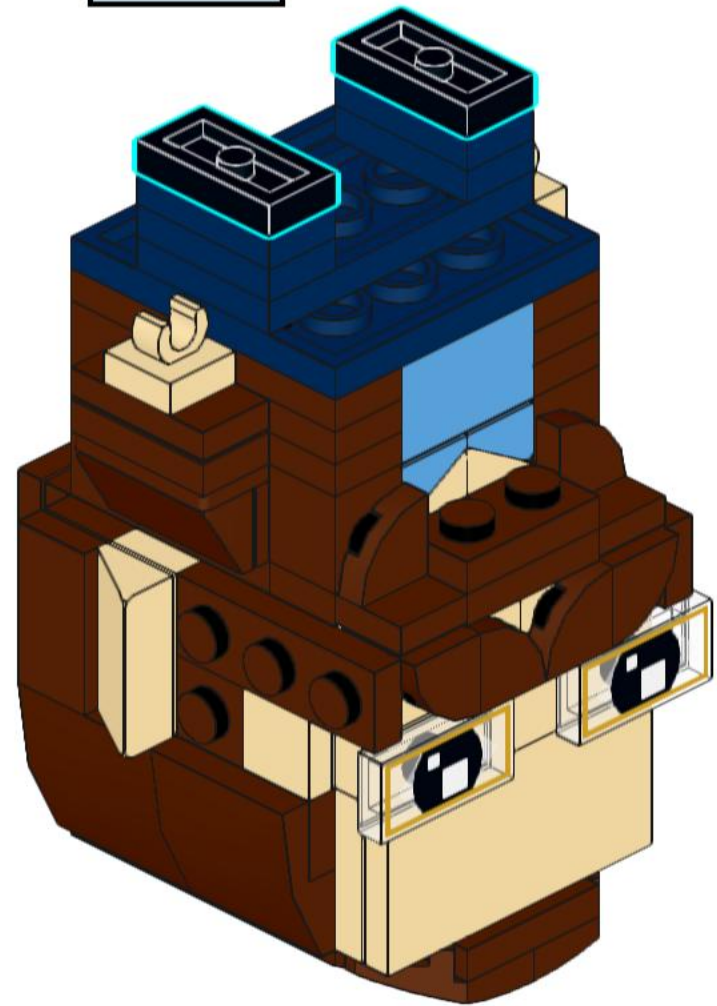
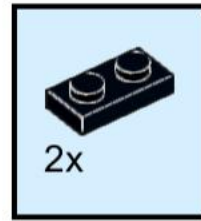

48

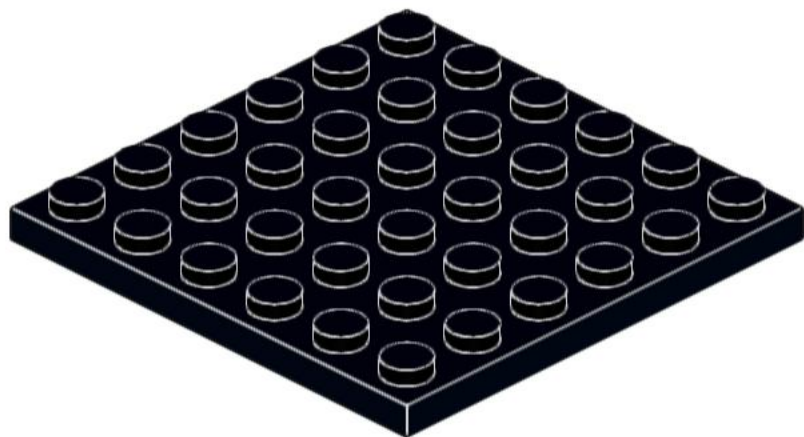
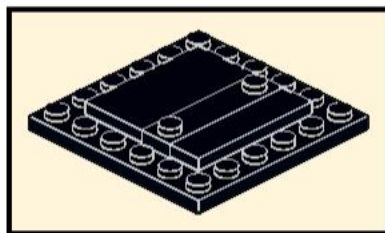
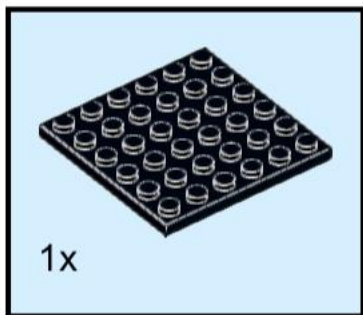

49

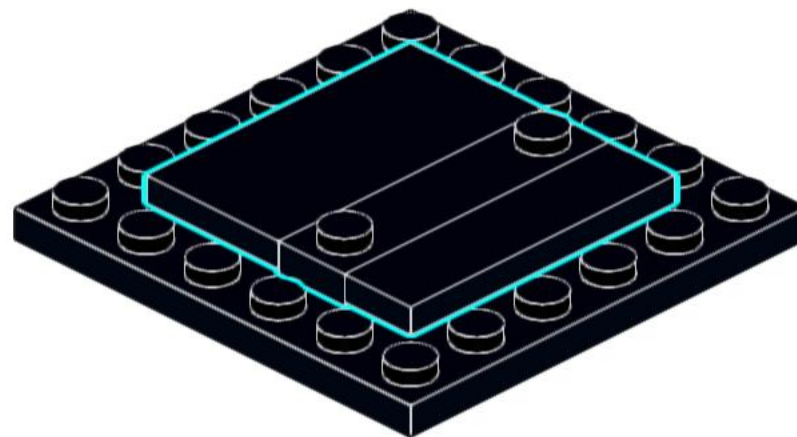
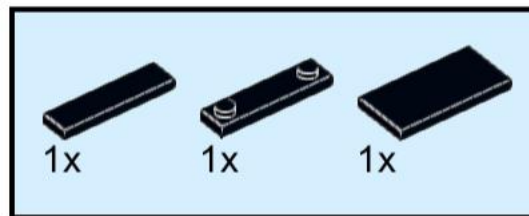

50

