

ADA HEADZ

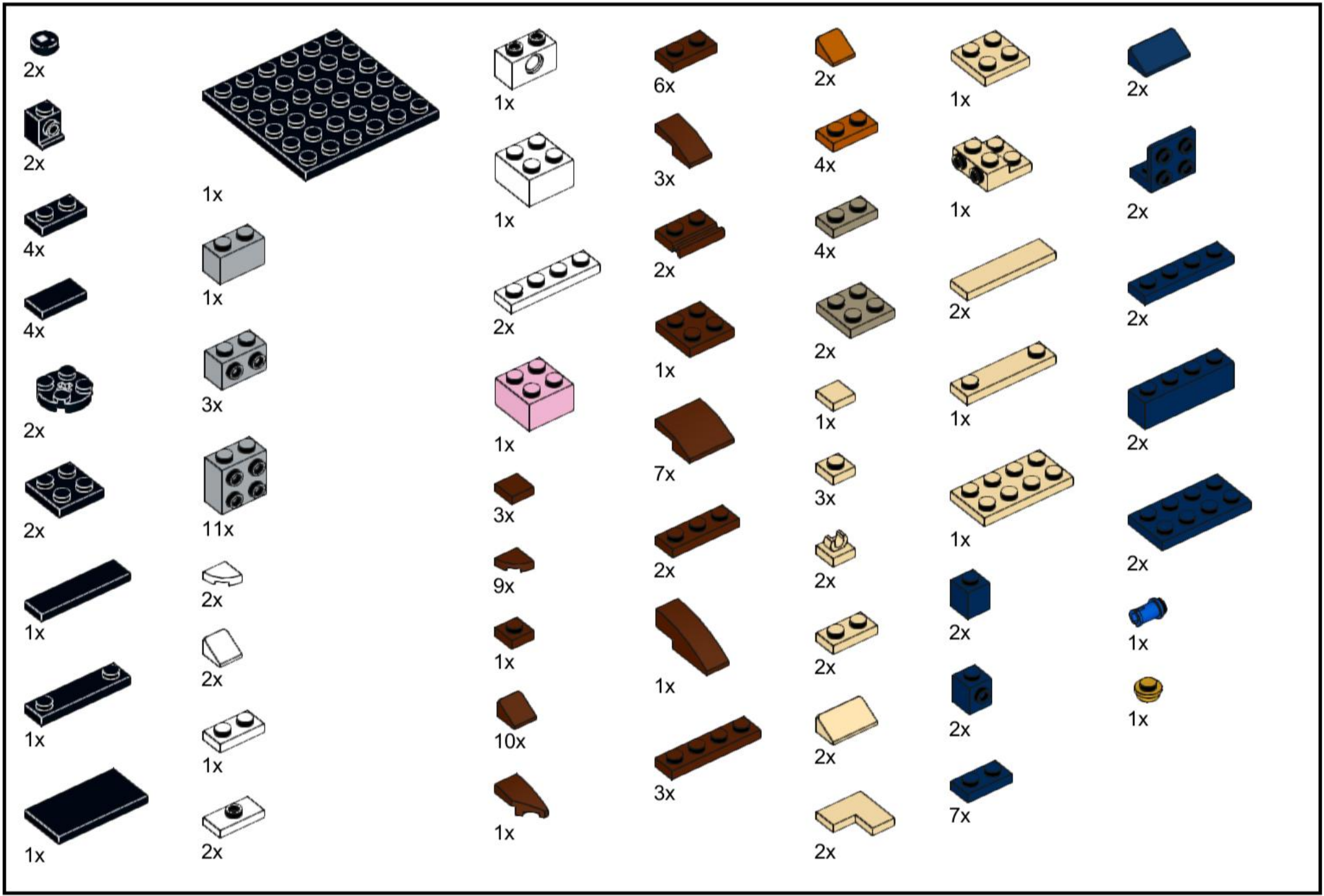

adaheadz.io/manuals

BYRON



1

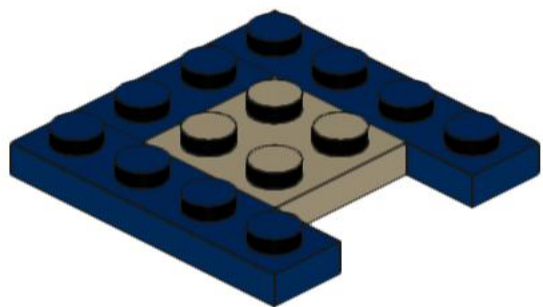
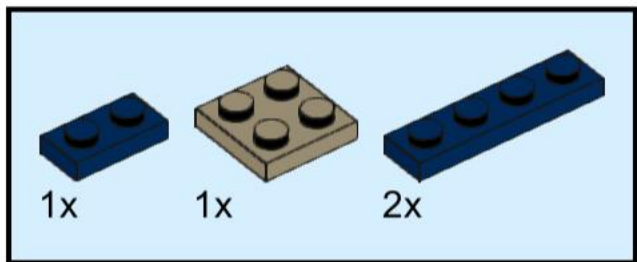

2

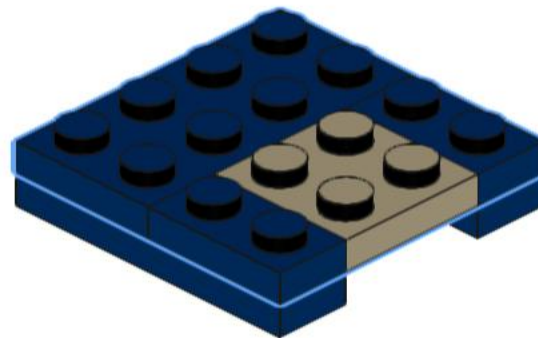
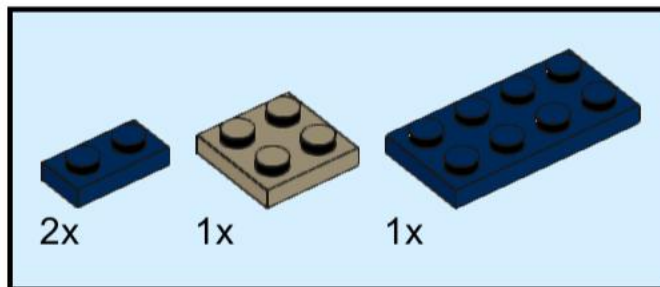

3

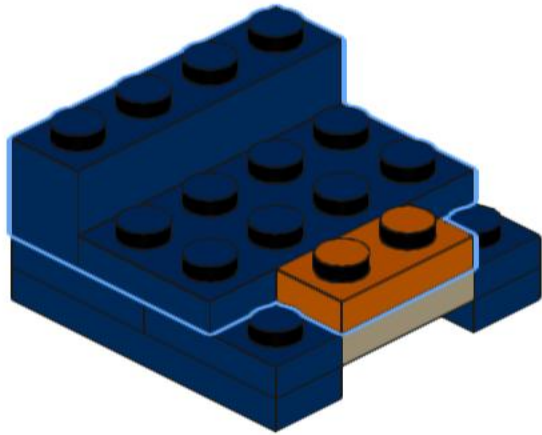
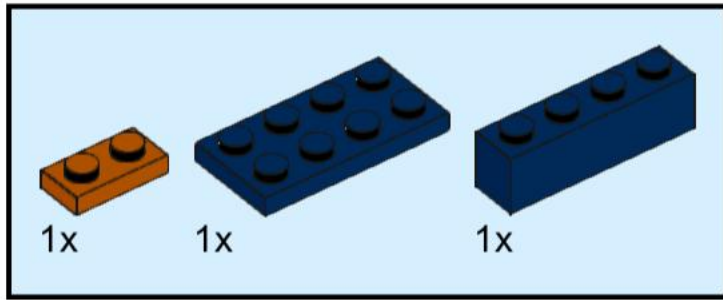

4

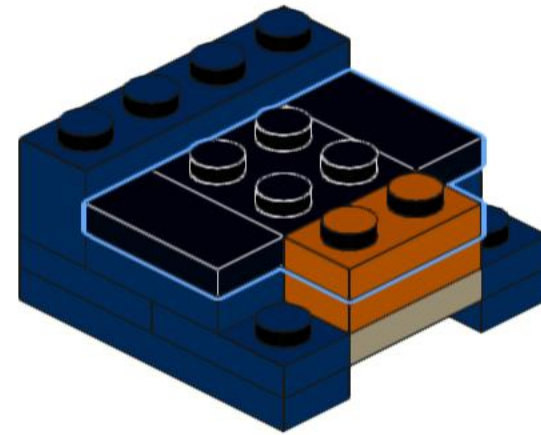
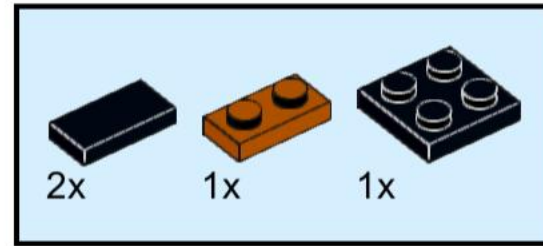

5

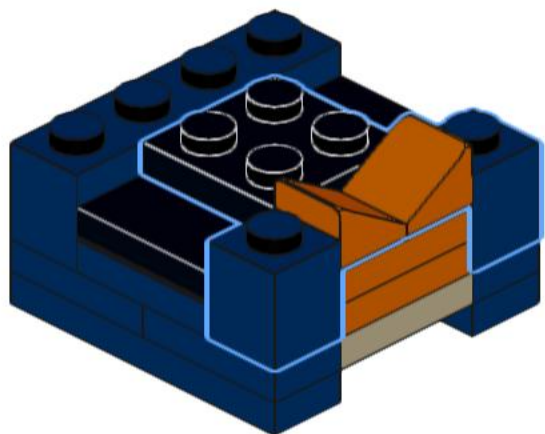
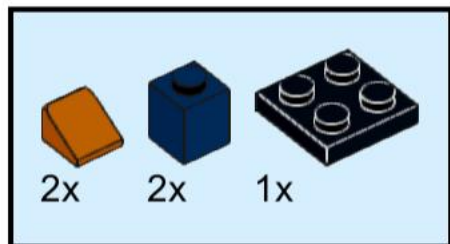

6

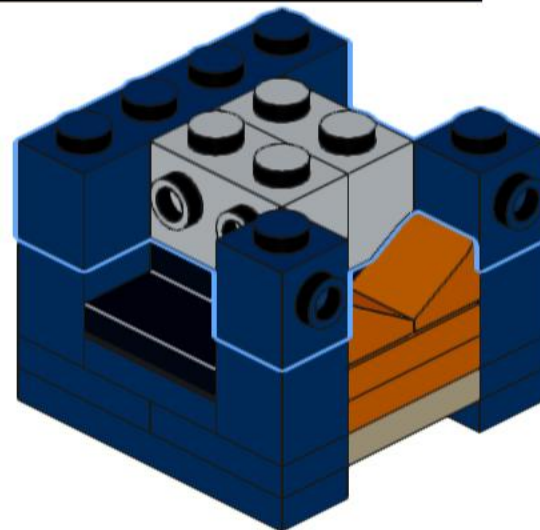
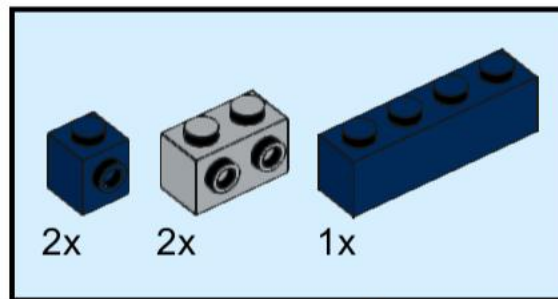

7

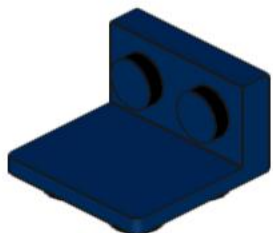
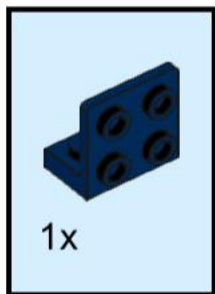

2x

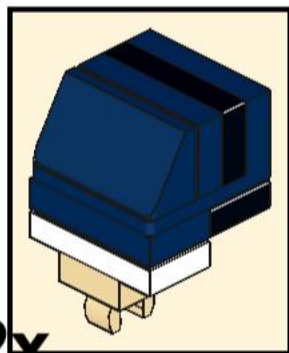

8

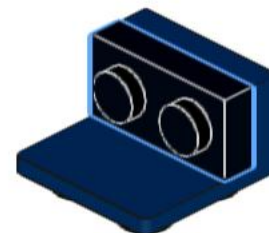
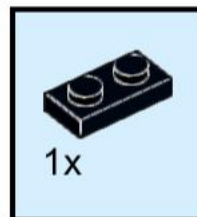

9

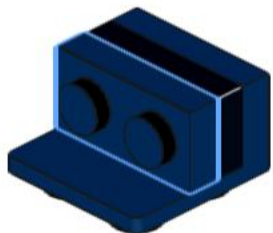
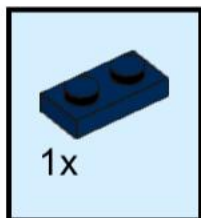

10

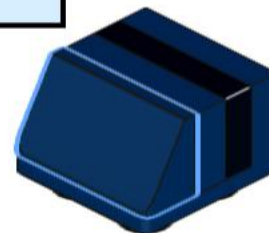
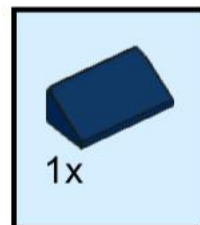

11

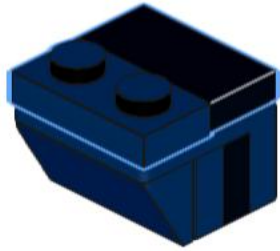
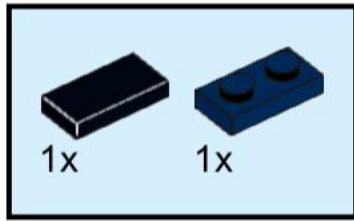

12

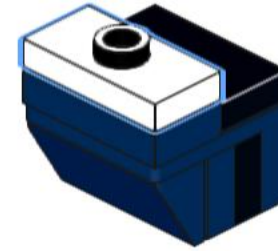
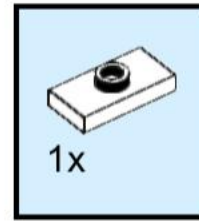

13

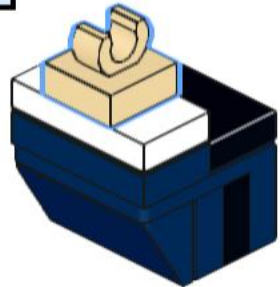
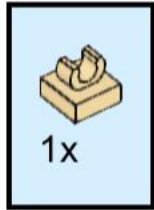

14

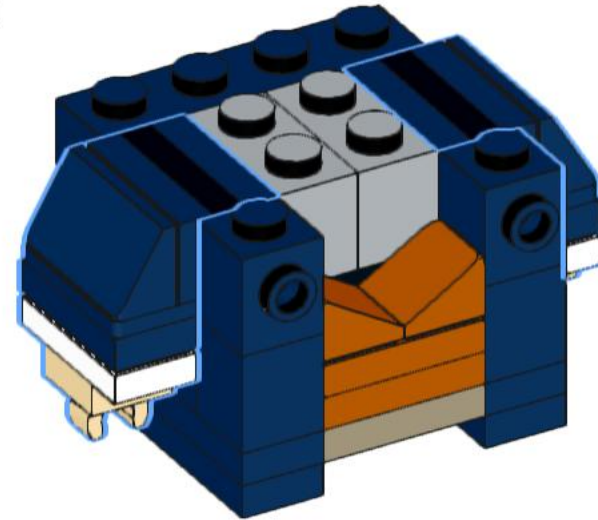

15

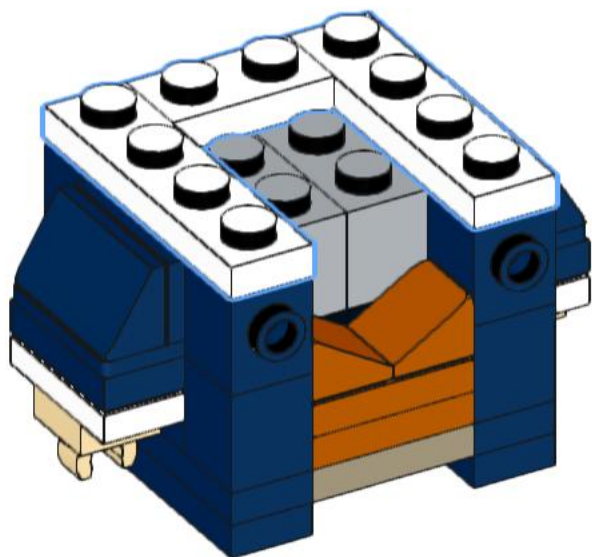
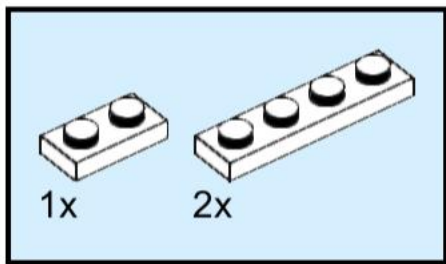

16

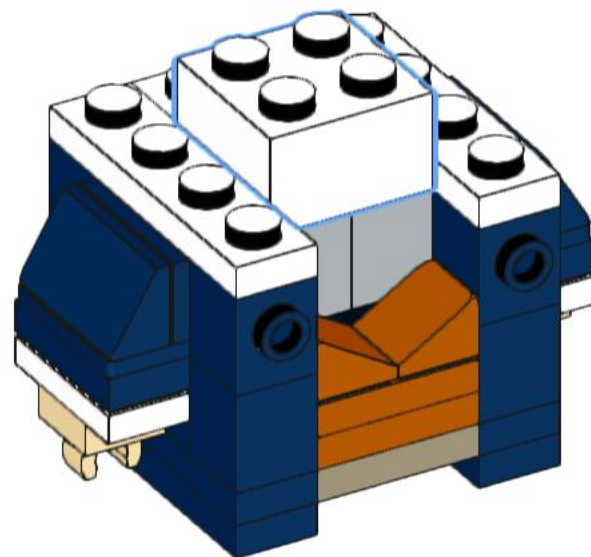
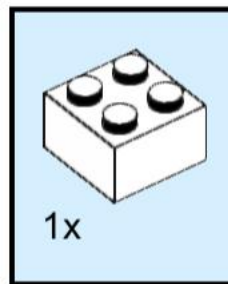

17

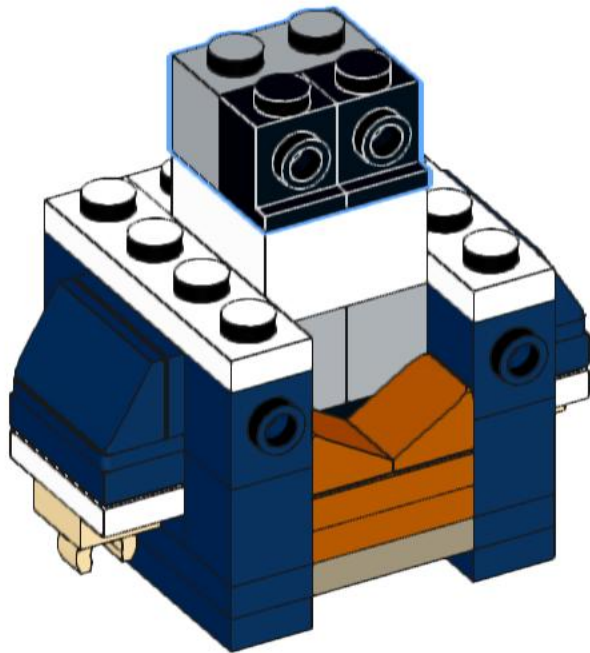
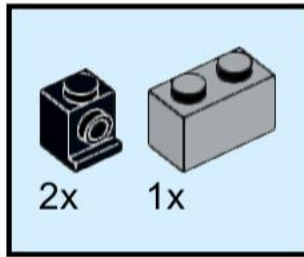

18

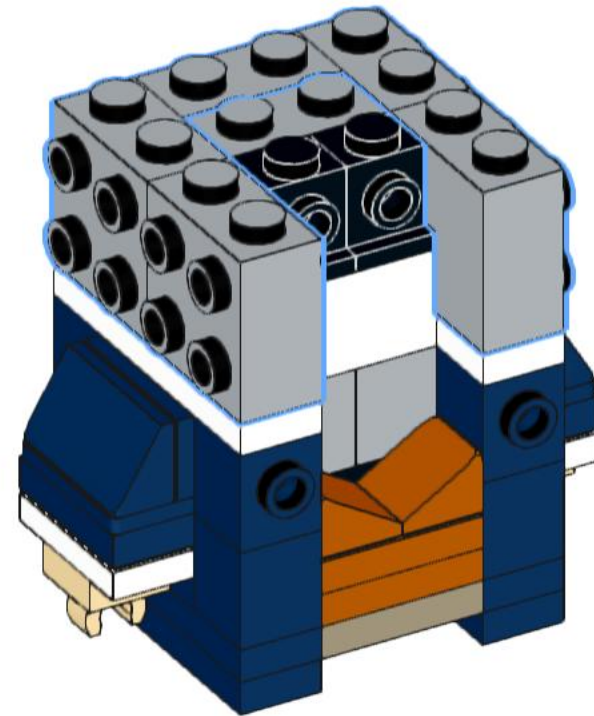
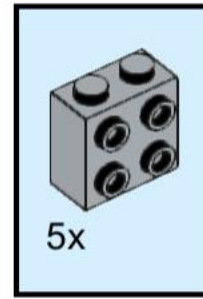

19

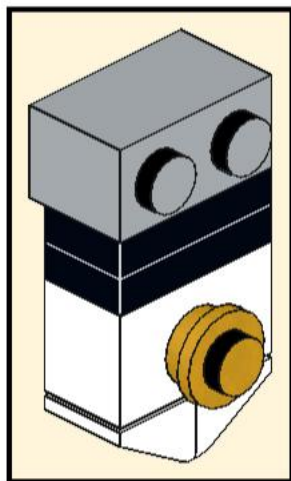
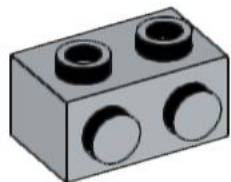
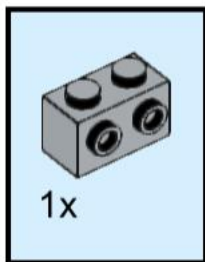

20

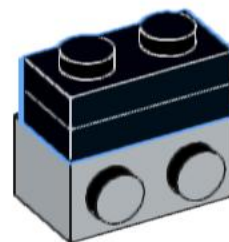
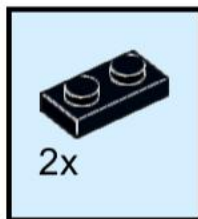

21

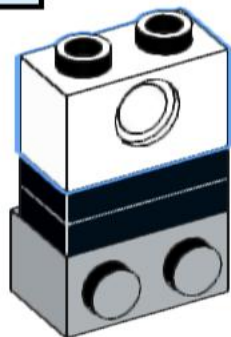
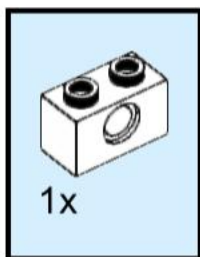

22

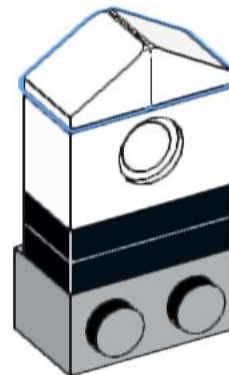
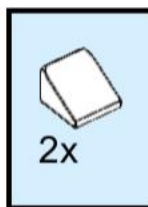

23

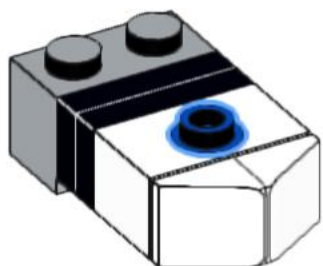
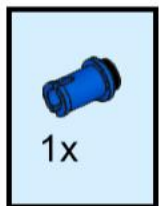

24

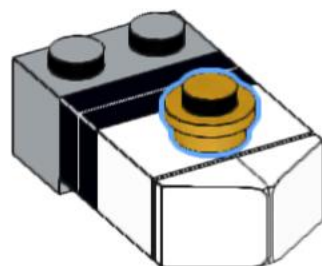
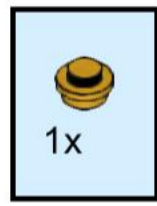

25

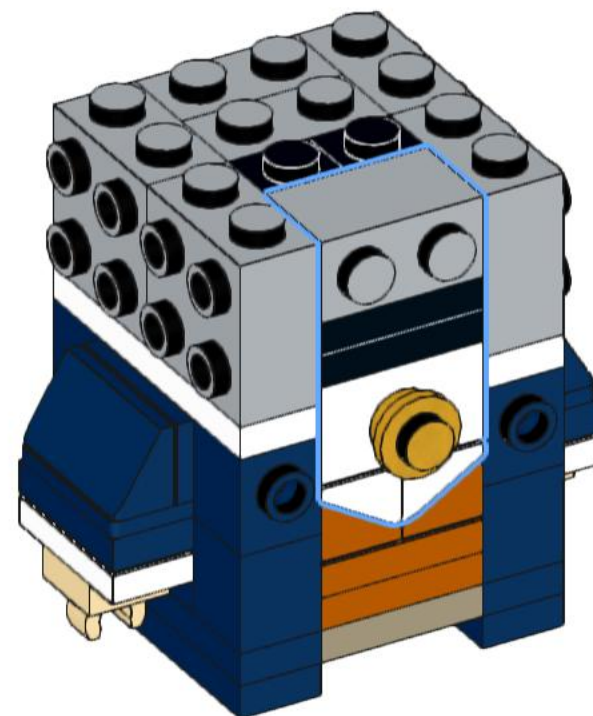

26

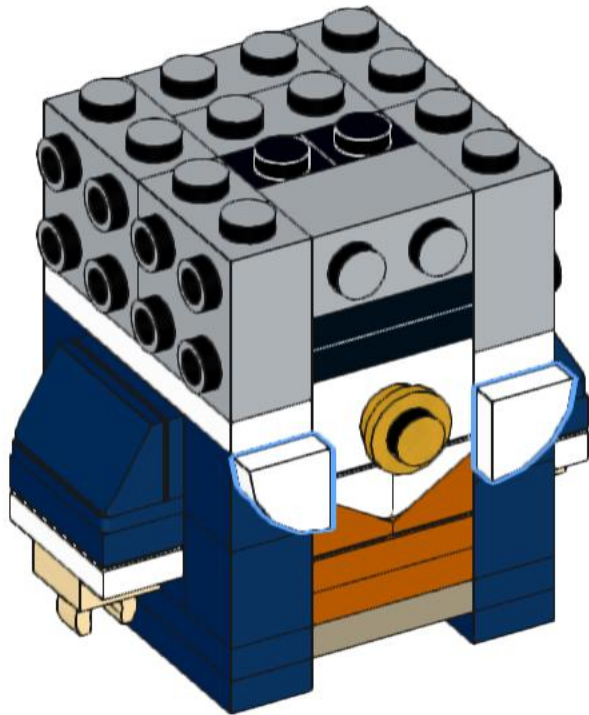
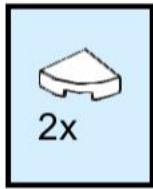

27

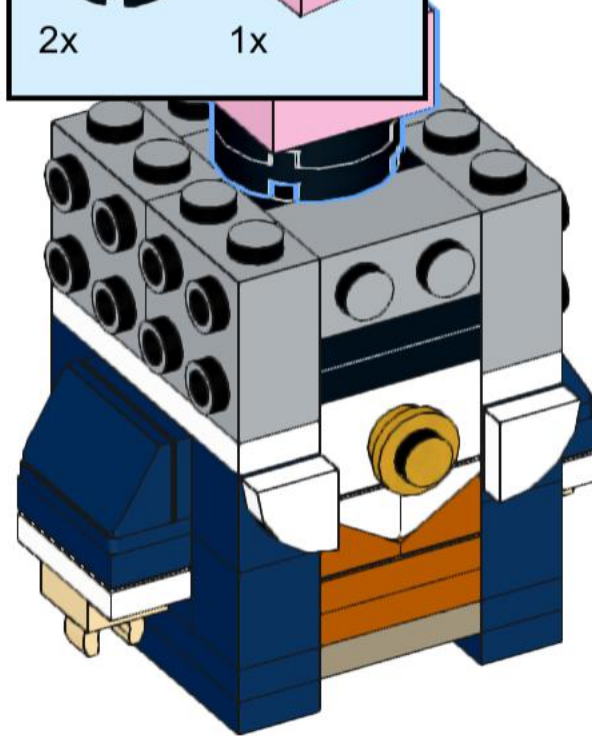
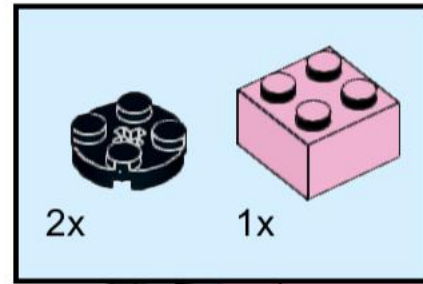

28

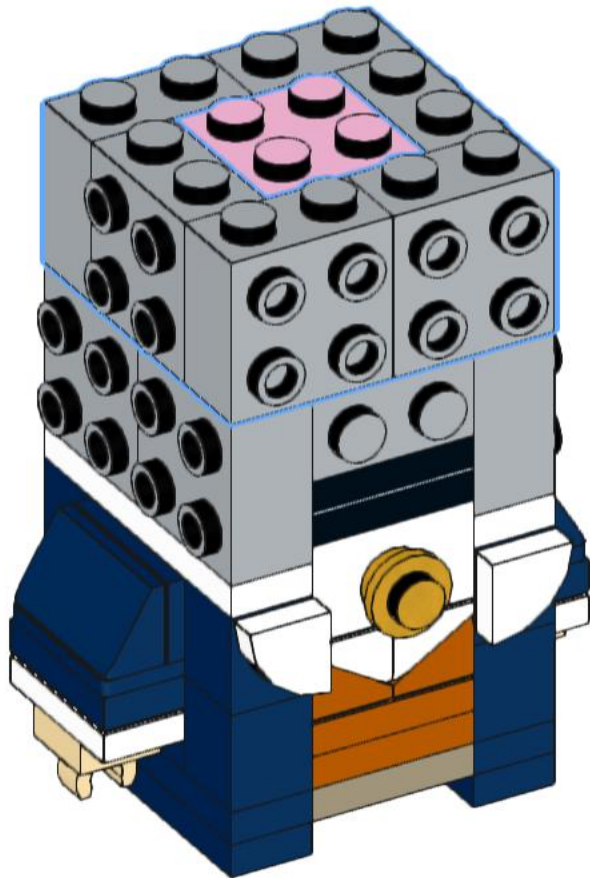
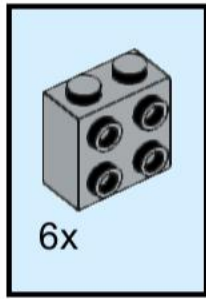

29

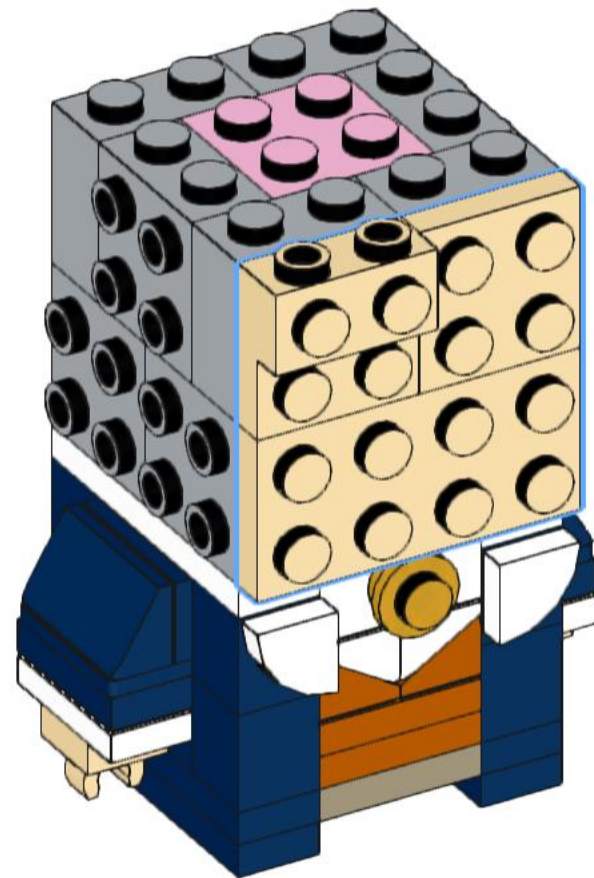
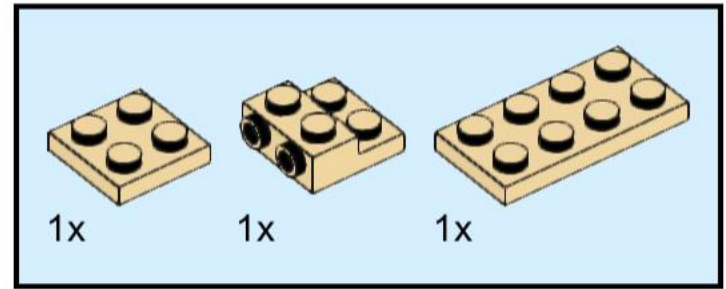

30

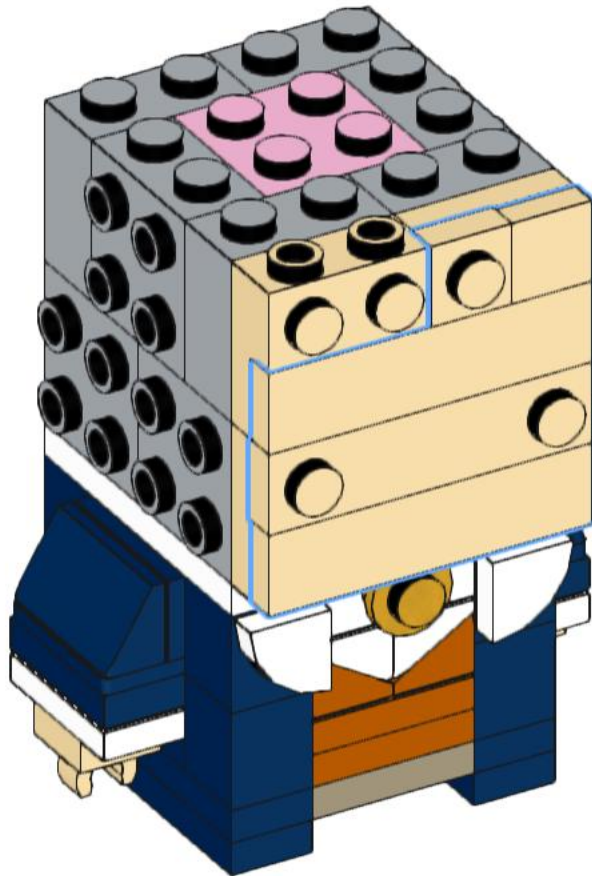
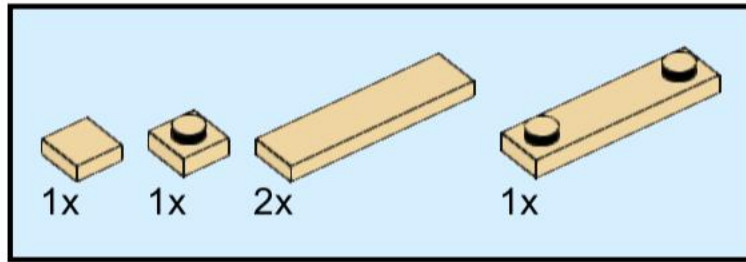

31

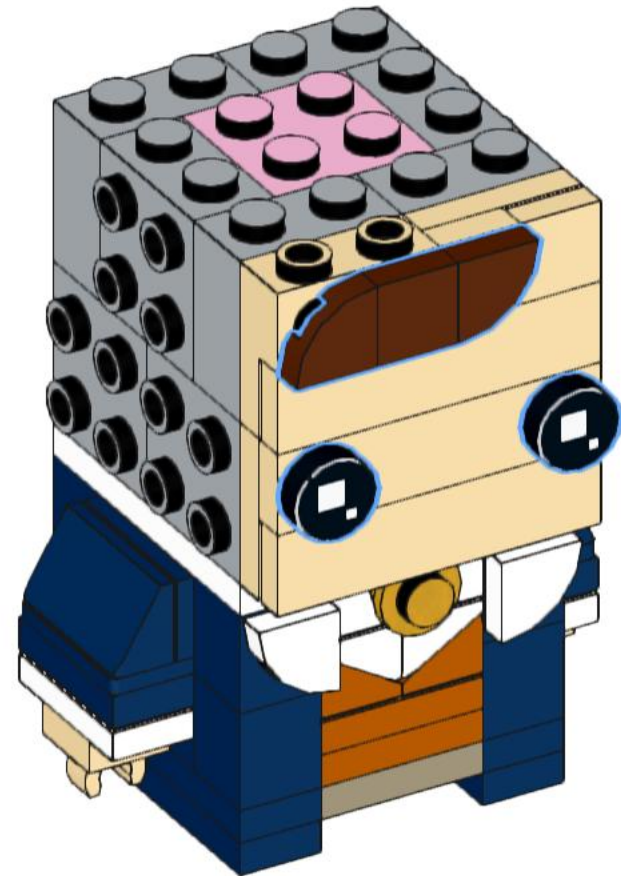

32

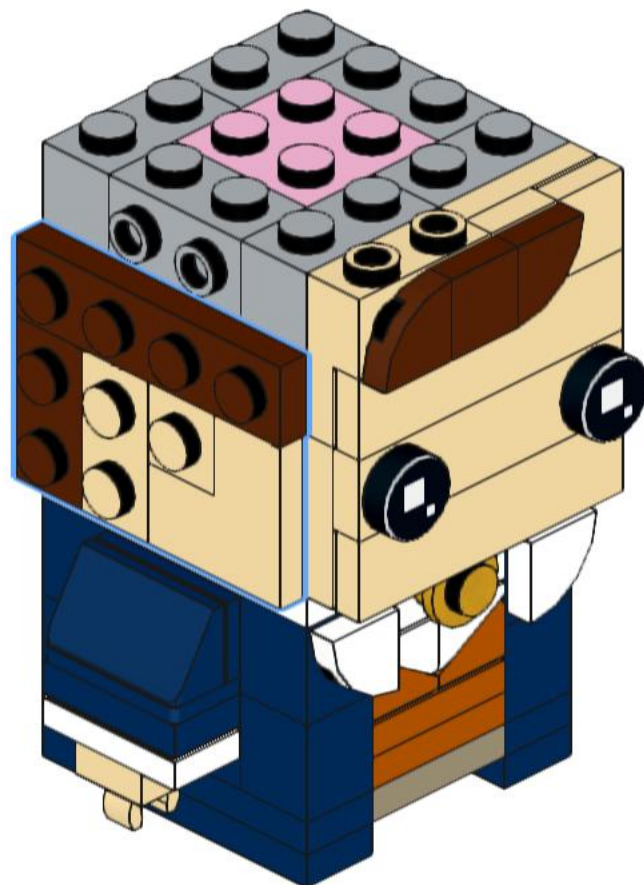
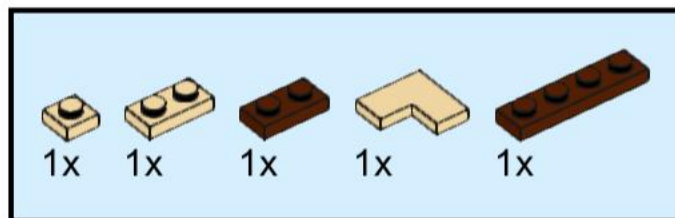

33

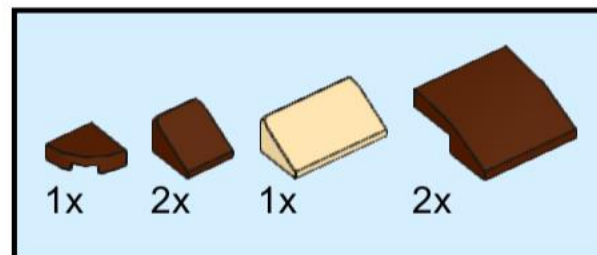

34

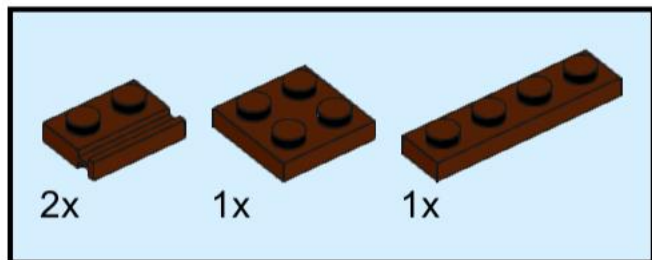

35

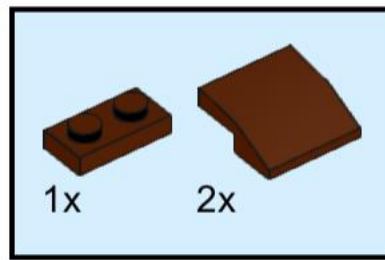

36

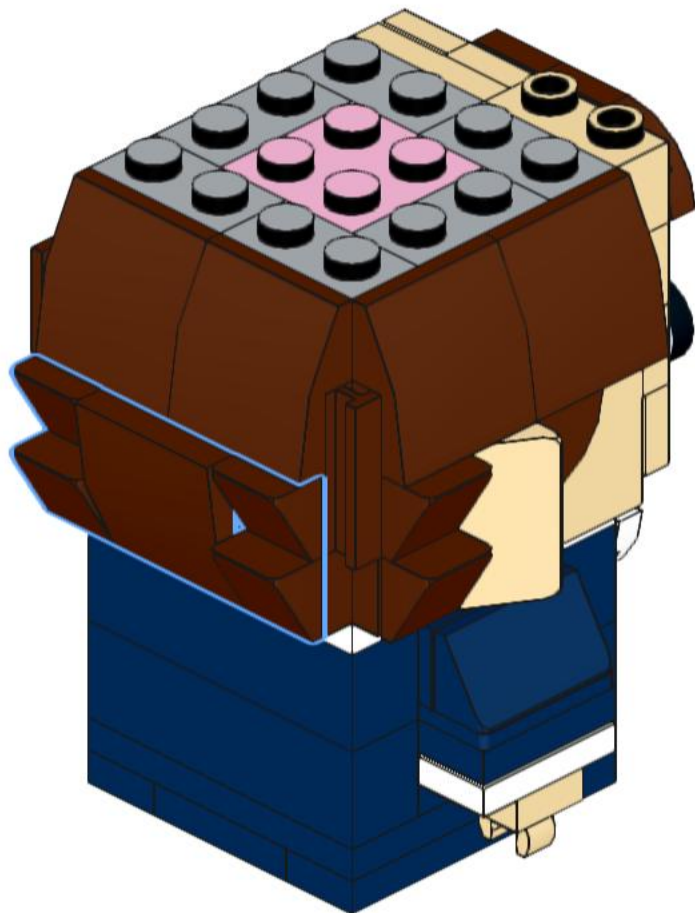
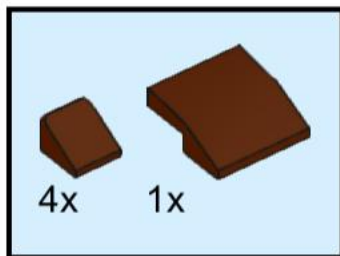

37

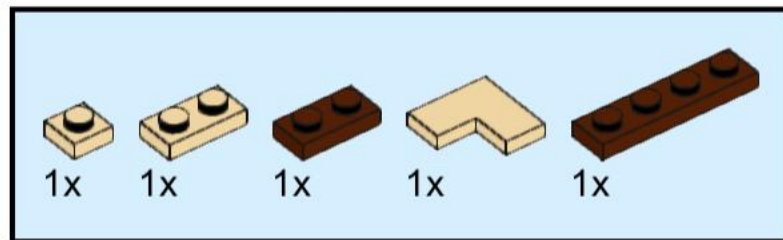

38

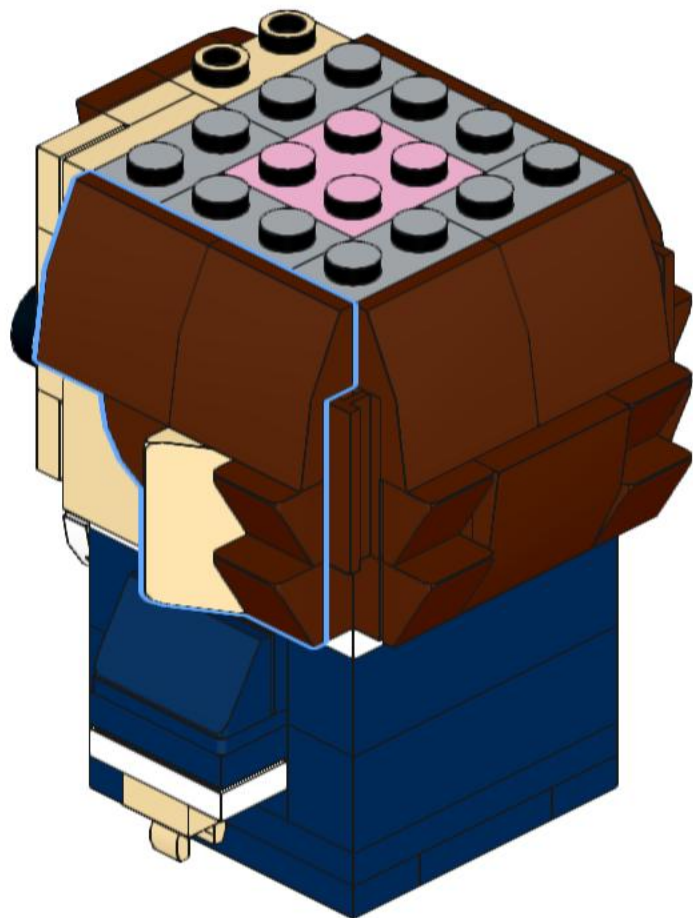
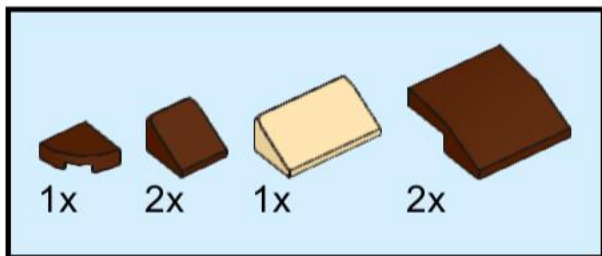

39

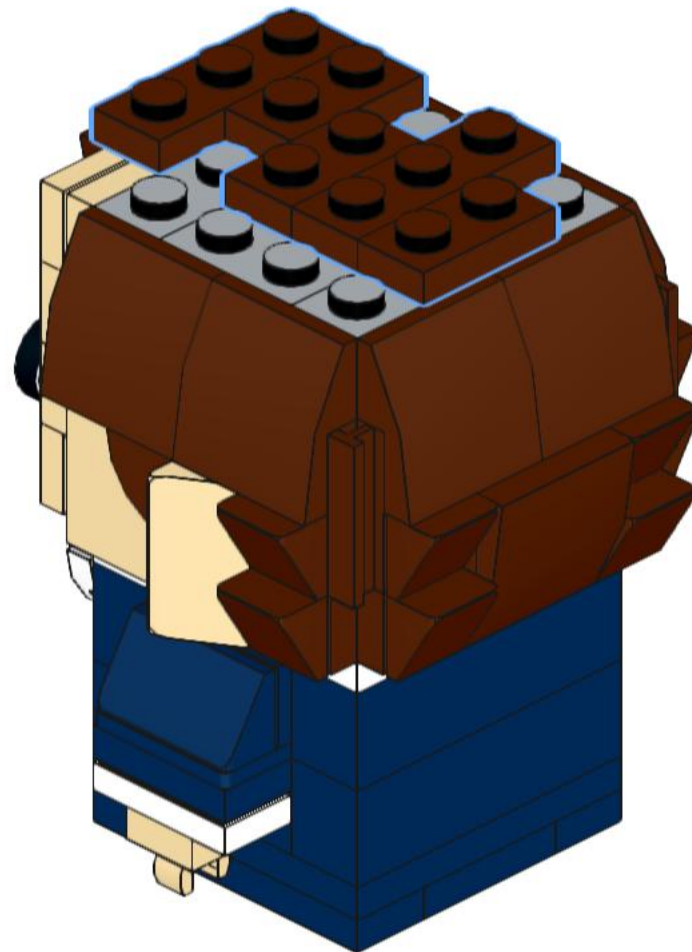
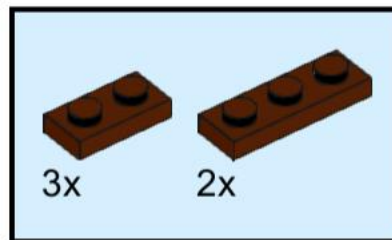

40

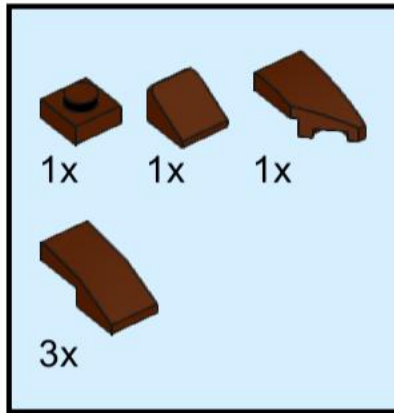

41

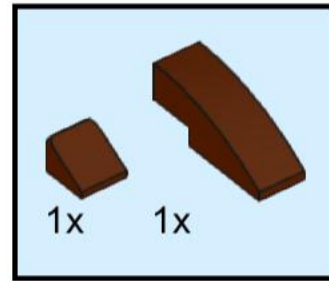

42

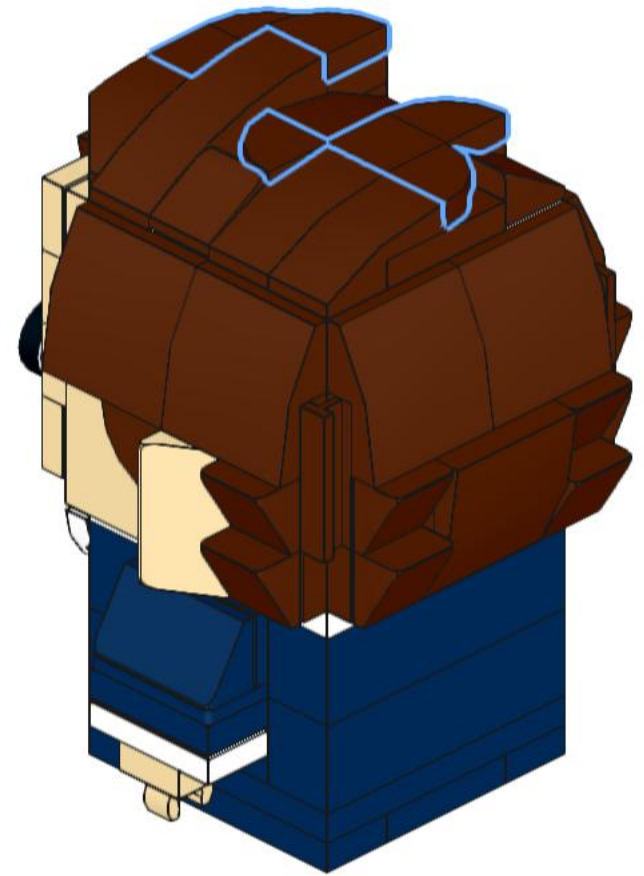
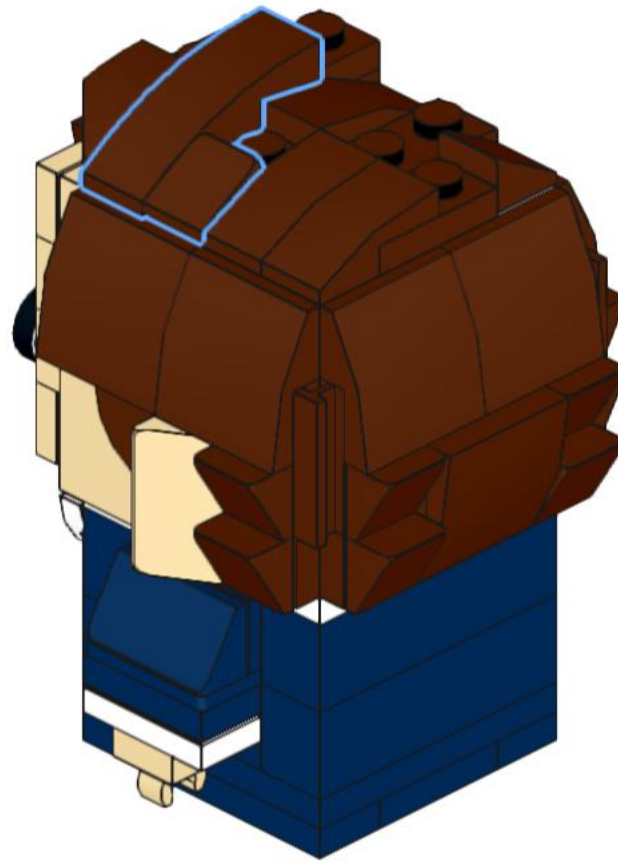
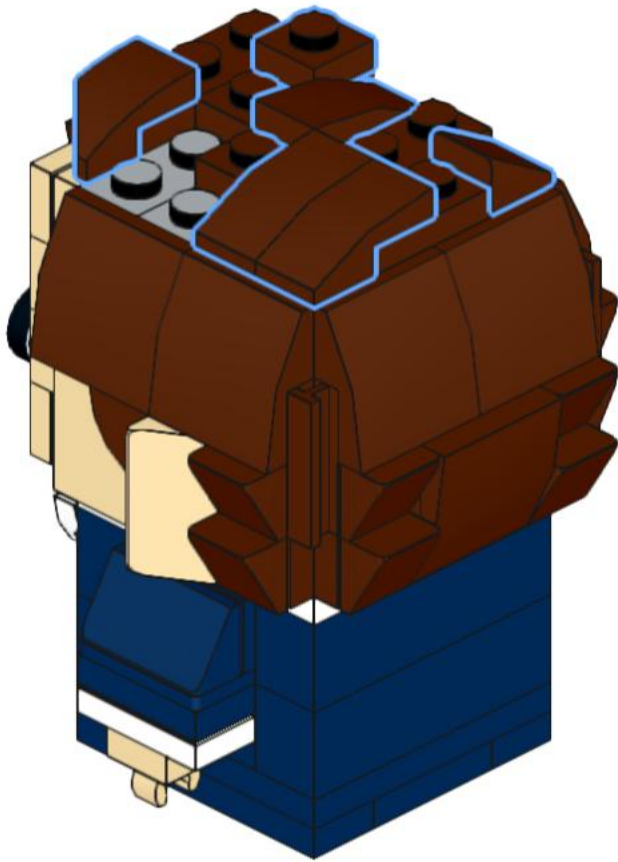
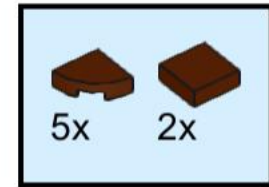

43

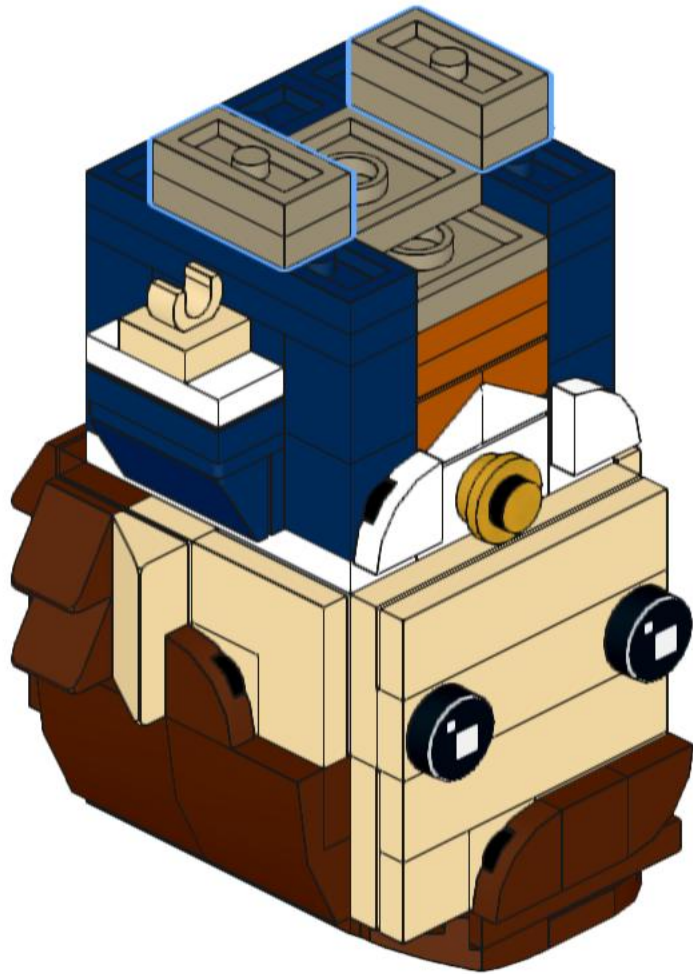
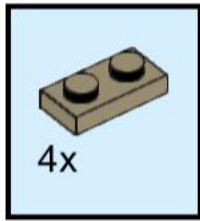

44

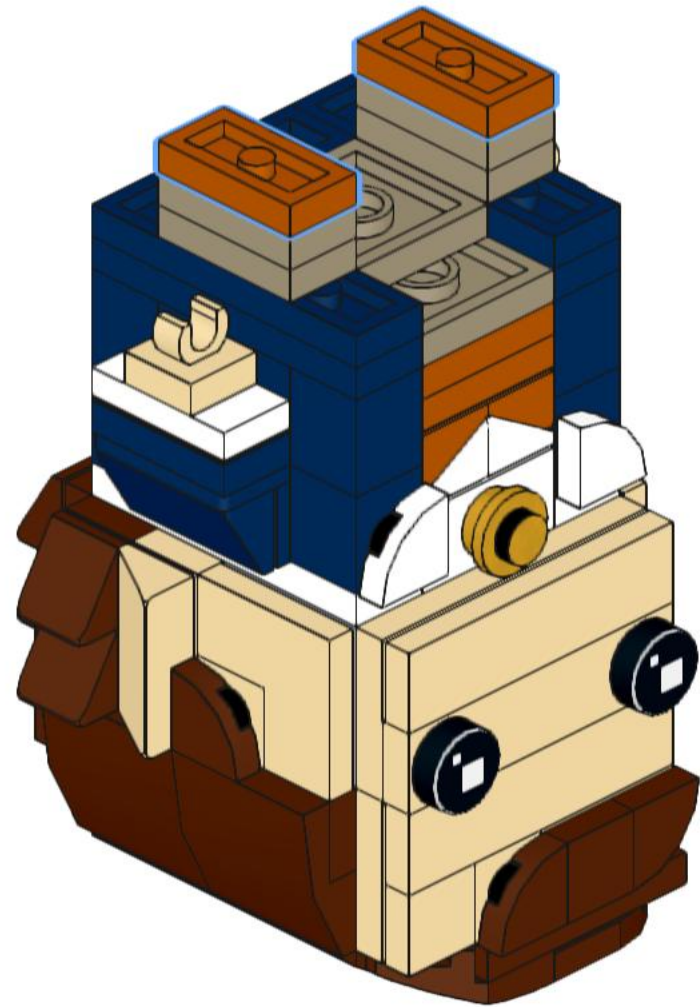
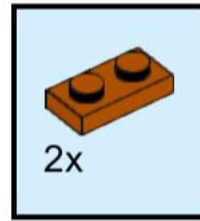

45

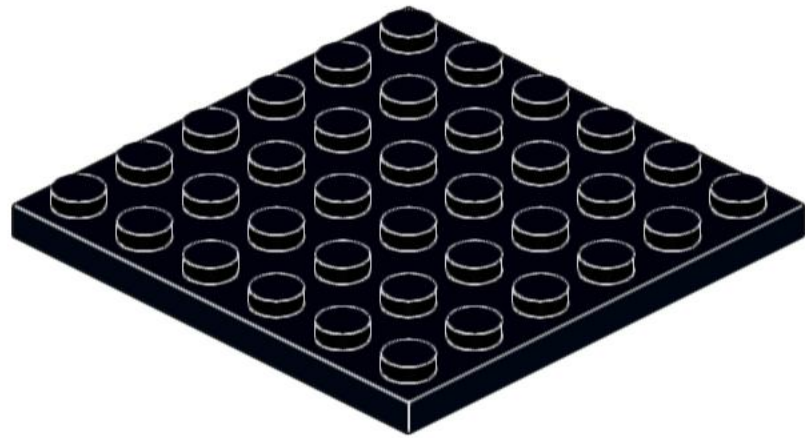
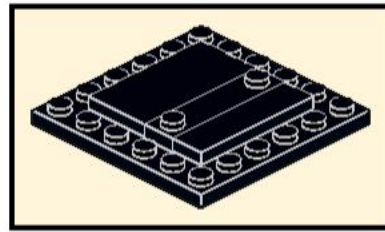
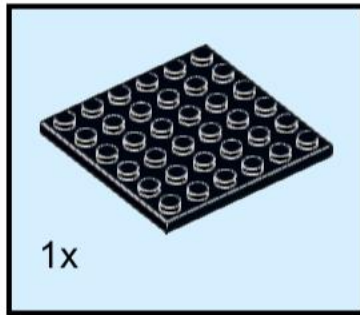

46

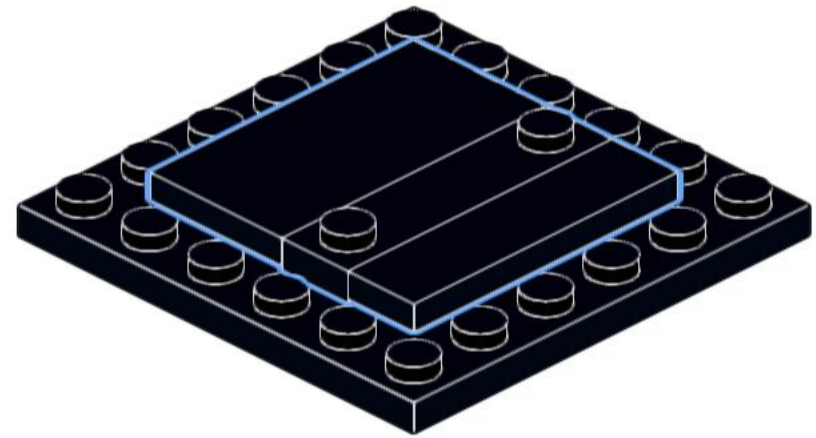
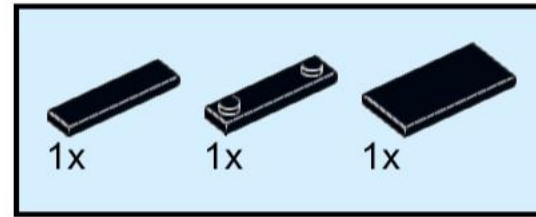

47

