

ADA HEADZ

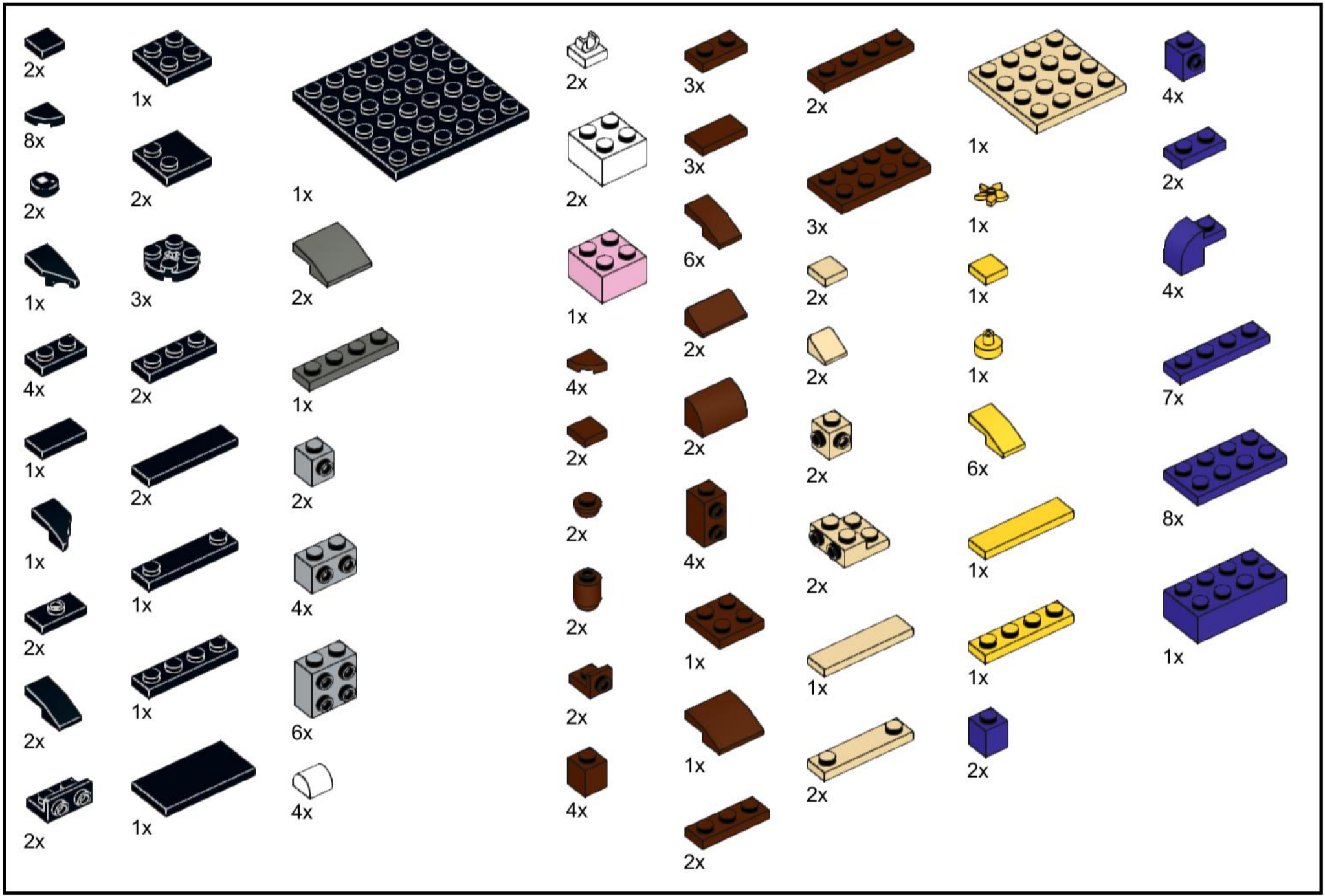

adaheadz.io/manuals

ADA



1

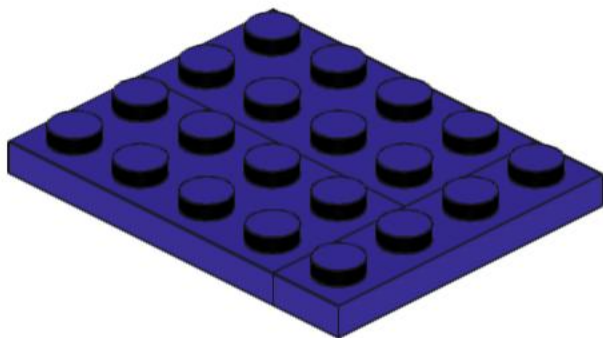
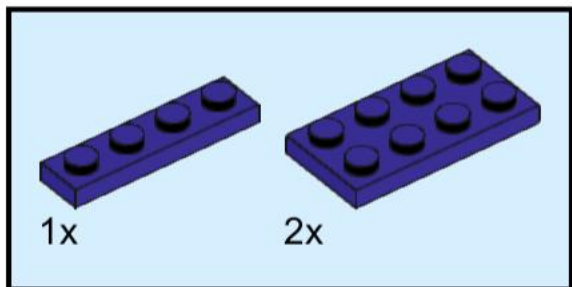

2

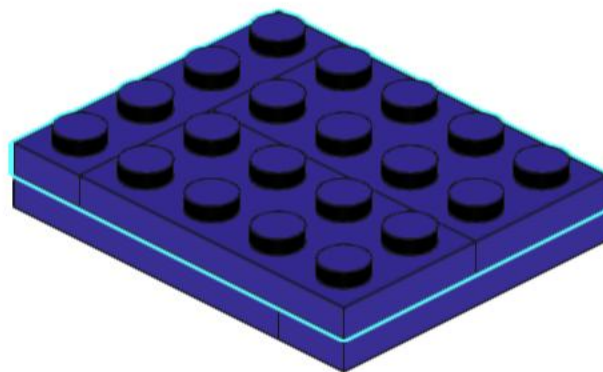
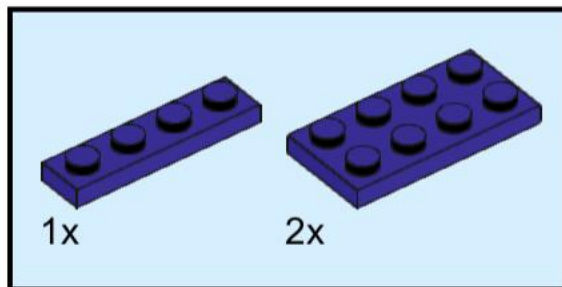

3

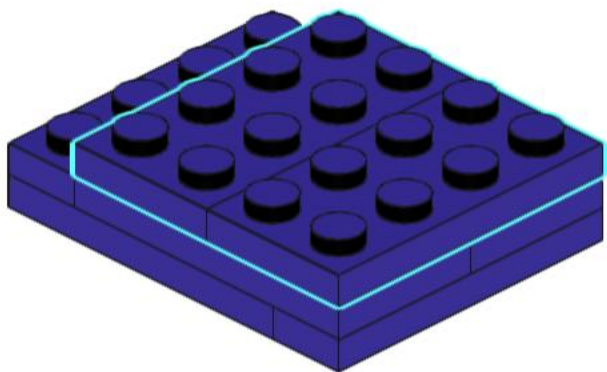
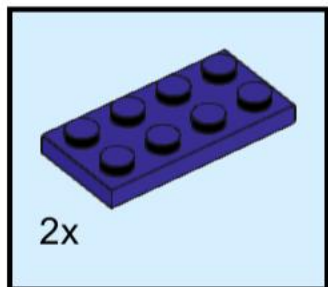

4

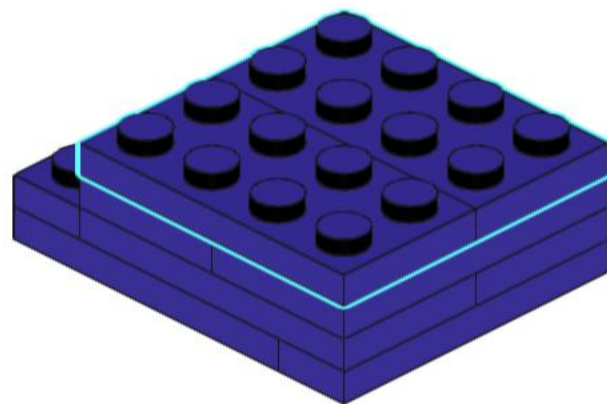
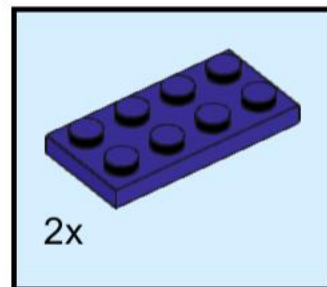

5

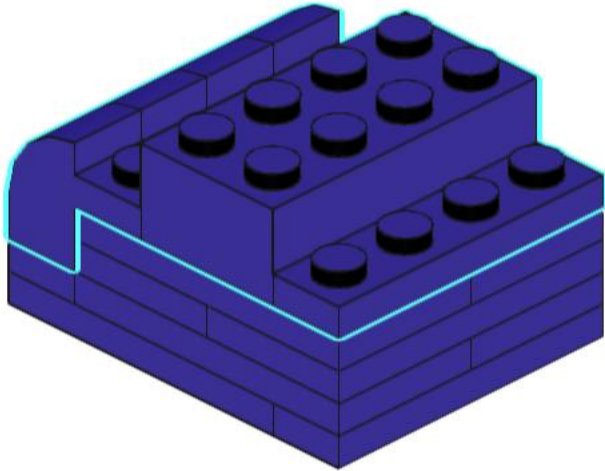
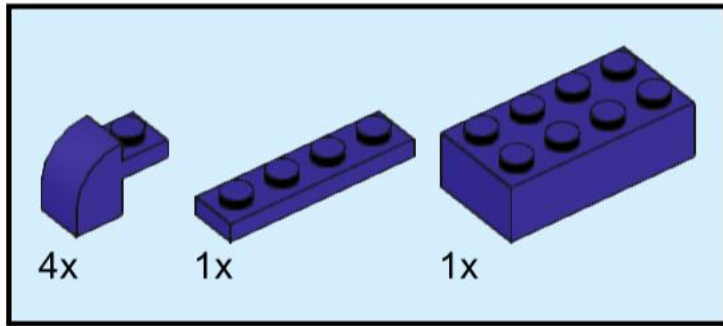

6

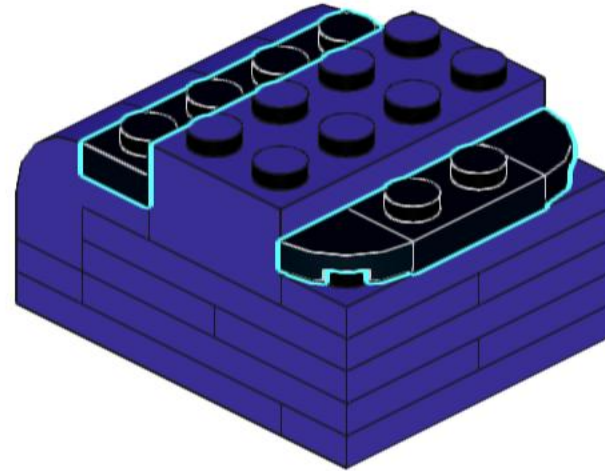
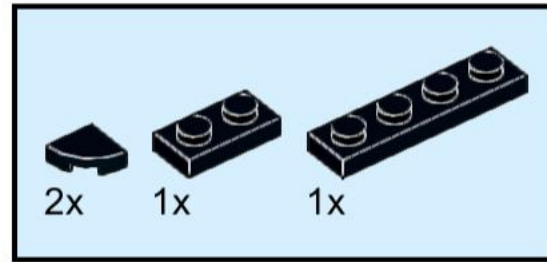

7

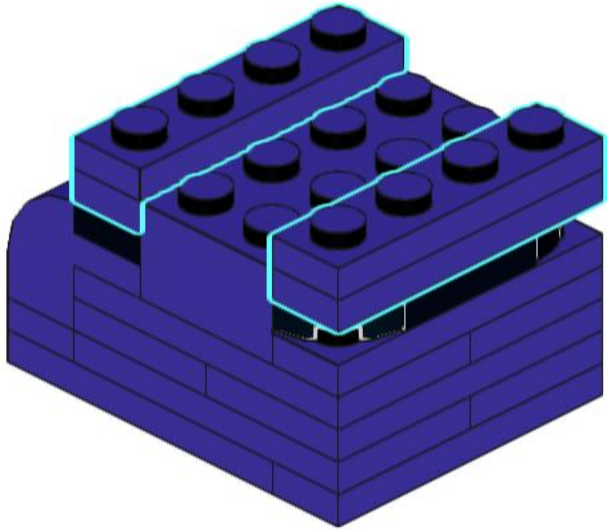
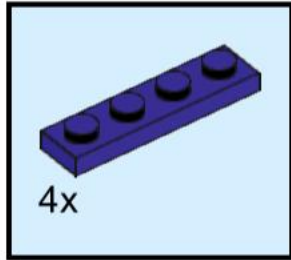

8

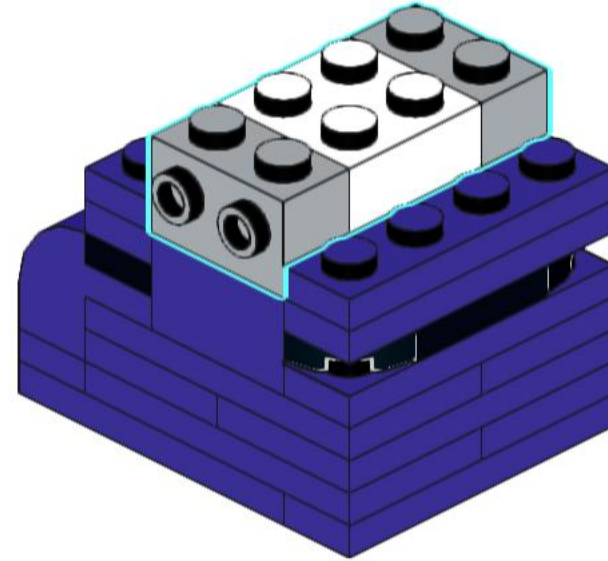
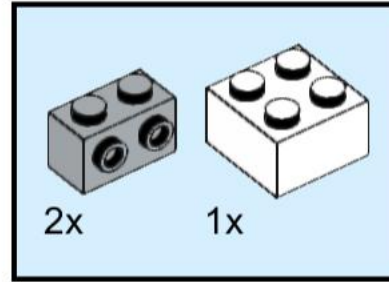

9

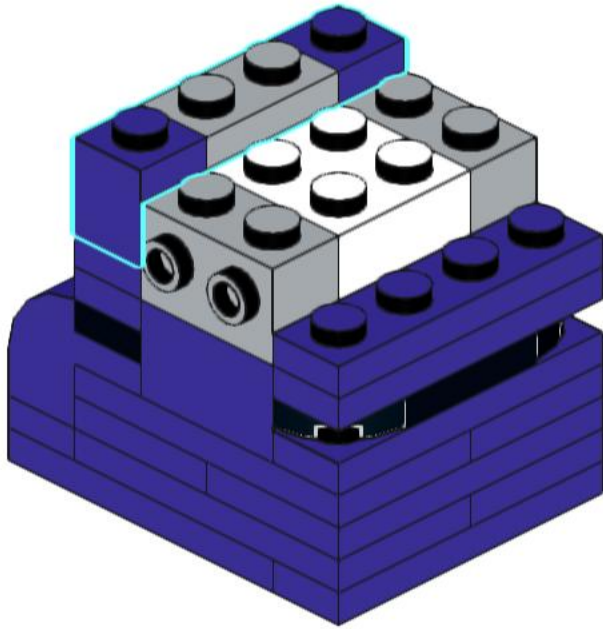
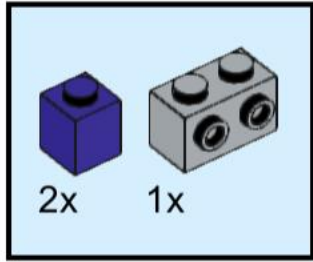

10

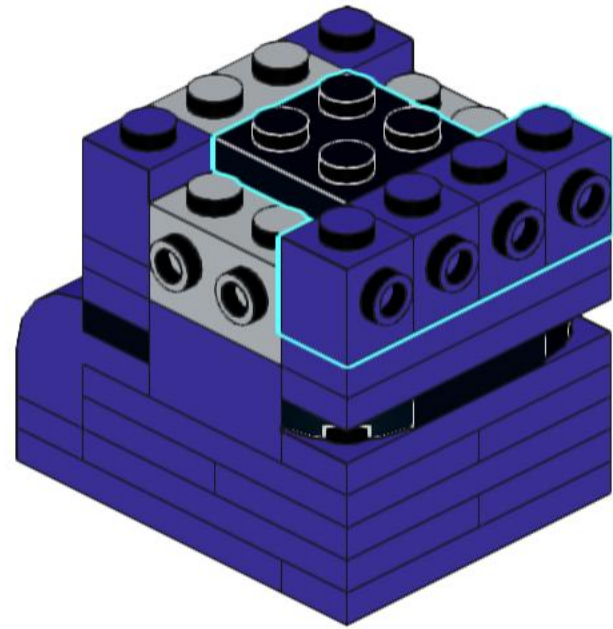
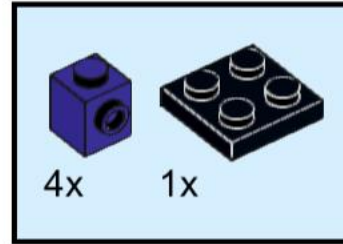

11

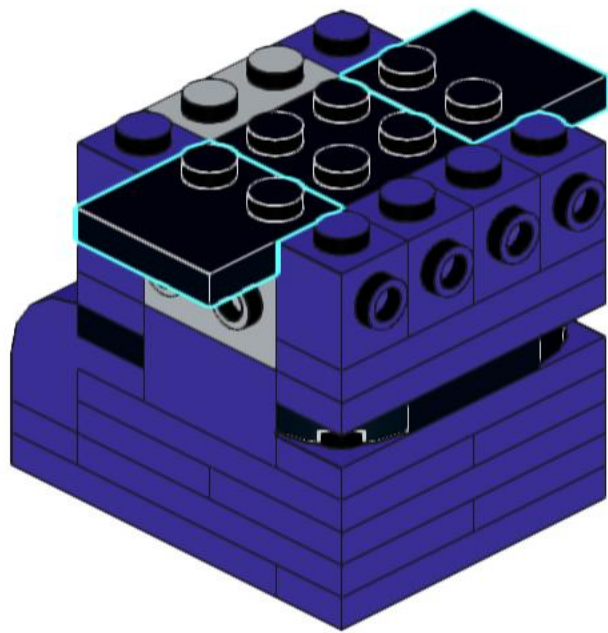
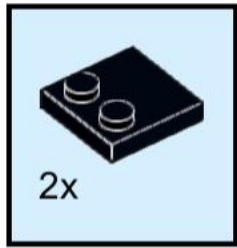

12

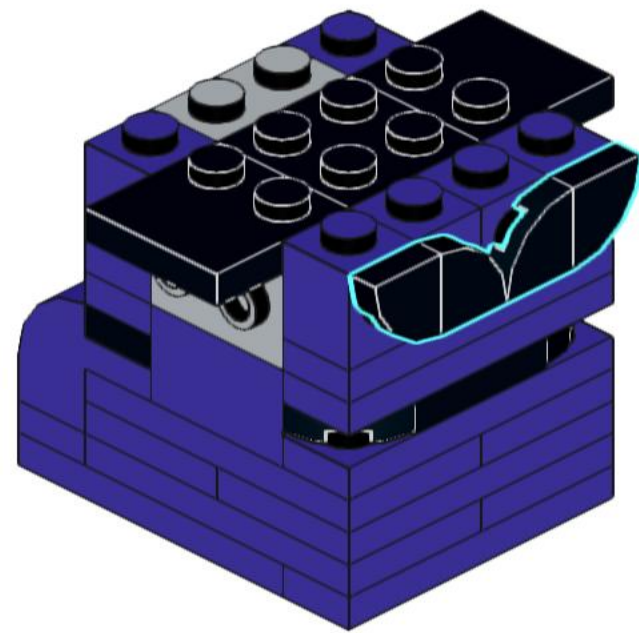

13

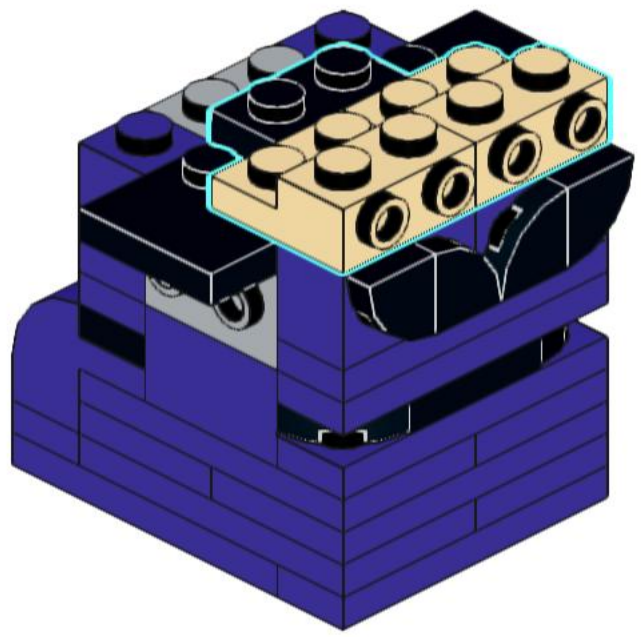
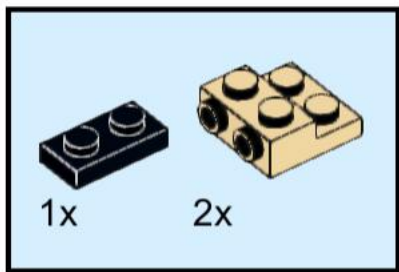

14

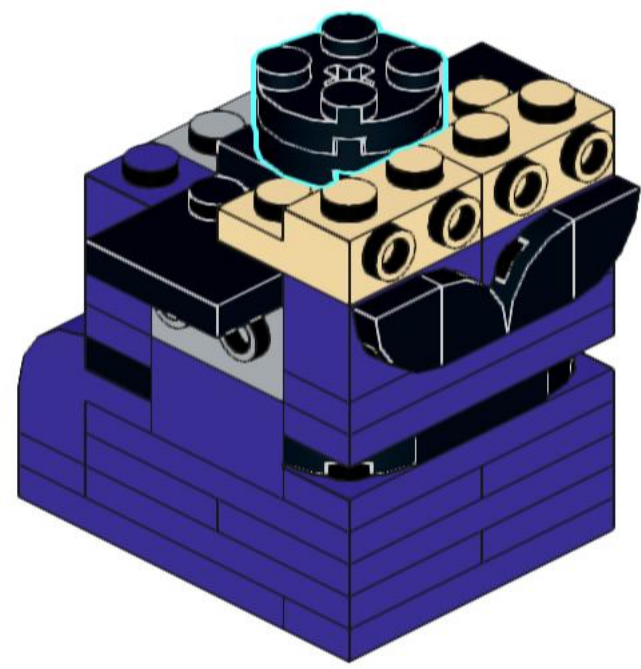
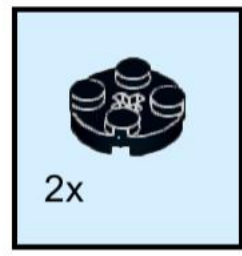

15

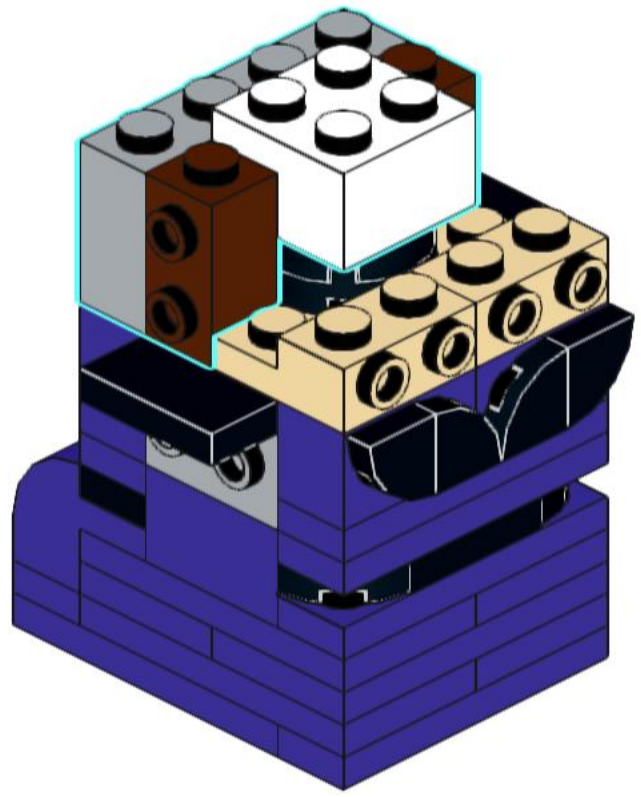
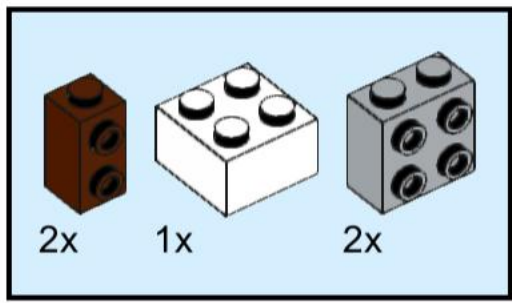

16

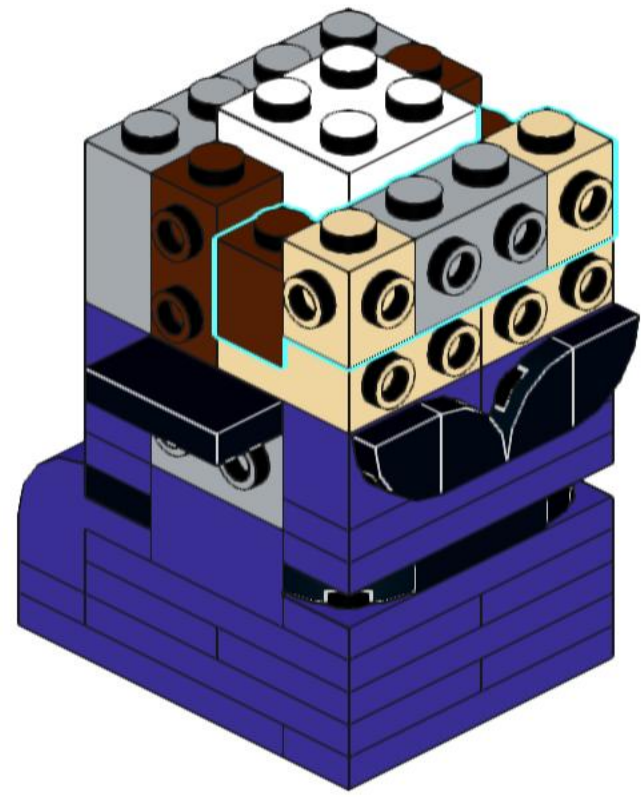
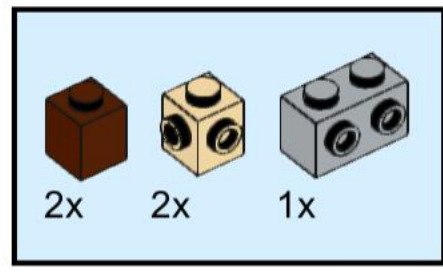

17

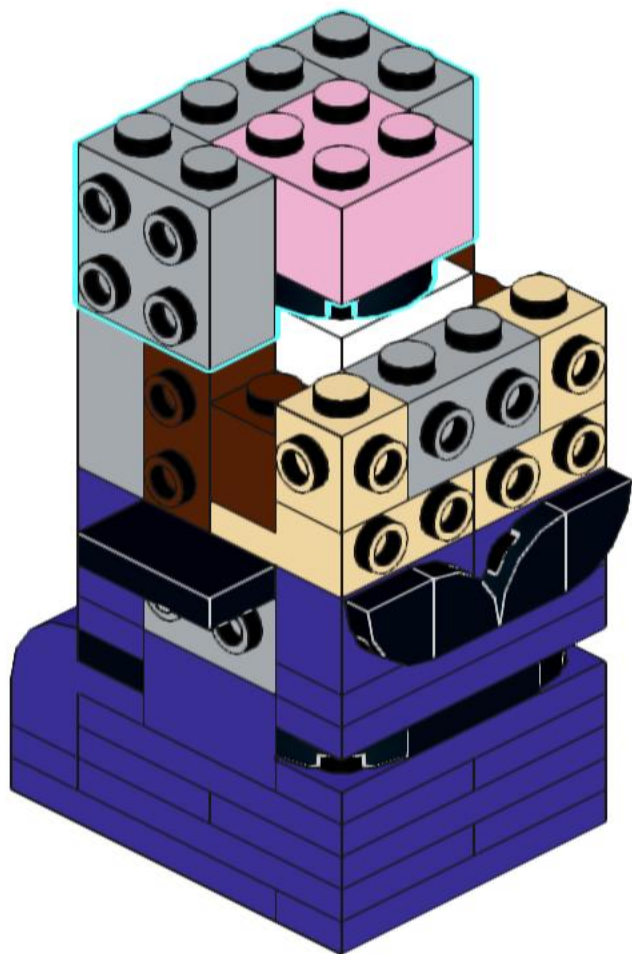
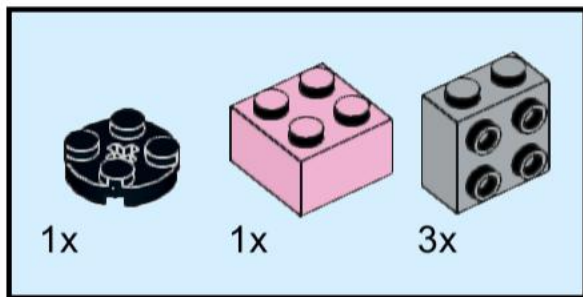

18

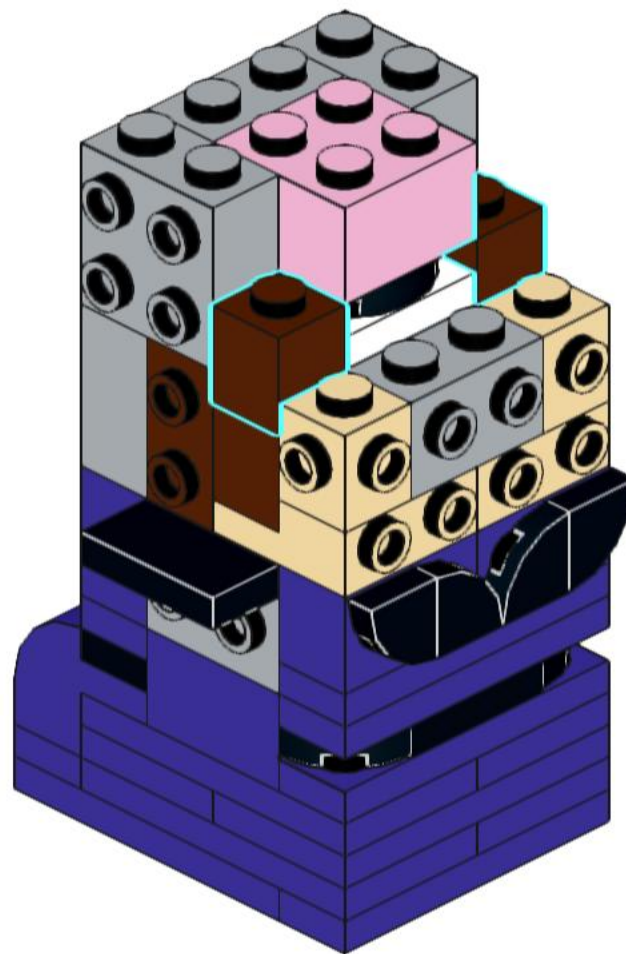
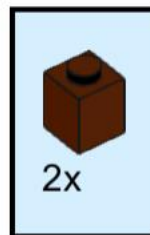

19

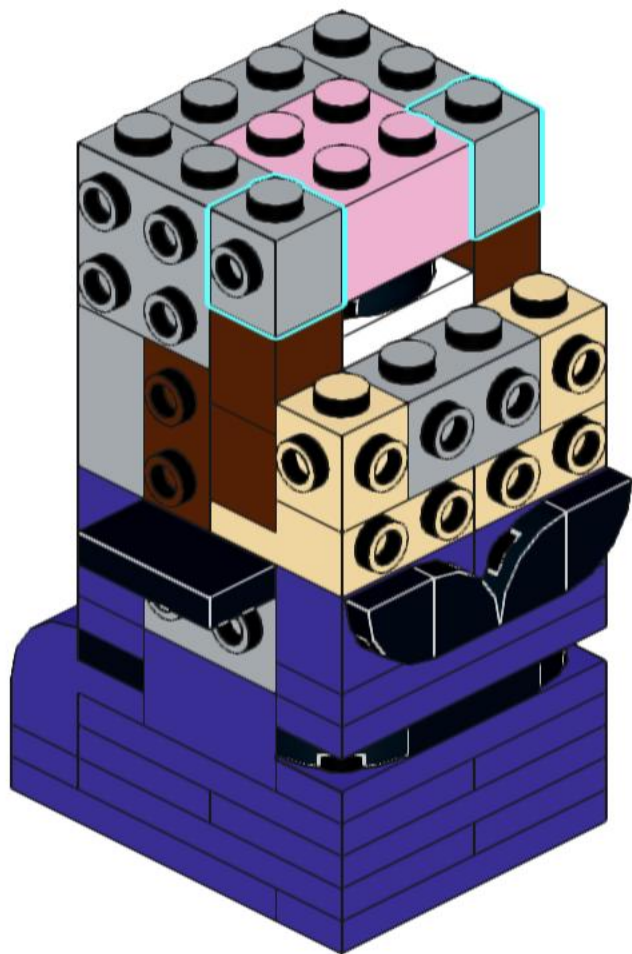
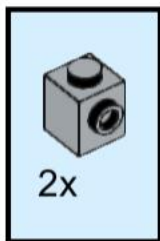

20

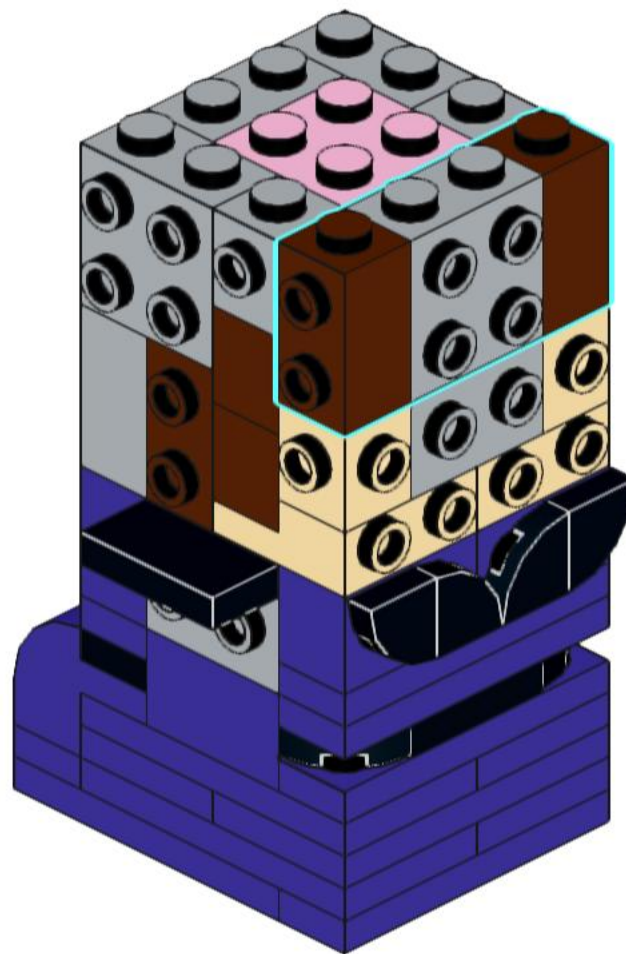
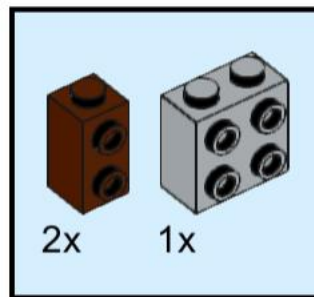

21

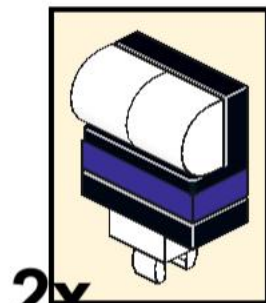
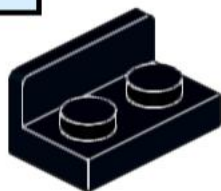
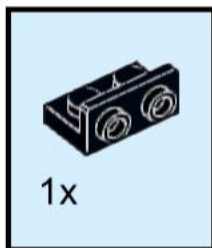

2x

22

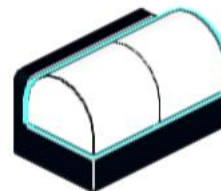
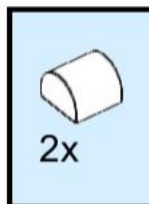

23

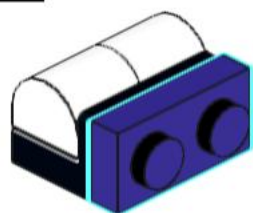
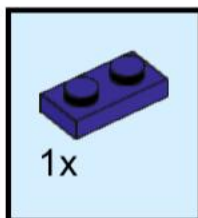

24

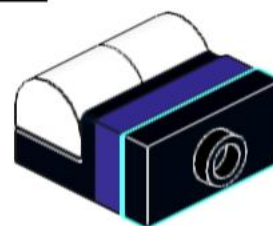
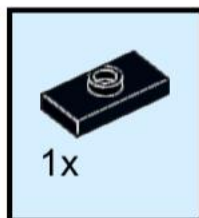

25

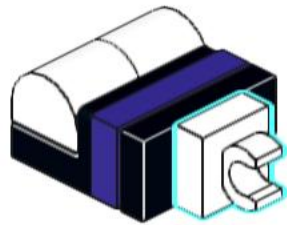
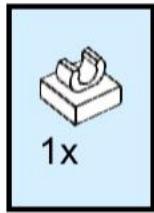

26



27

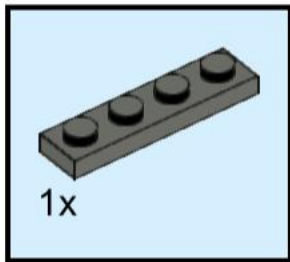
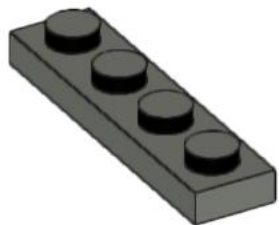
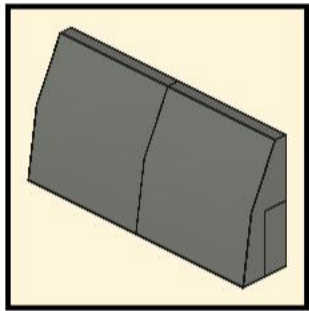

28

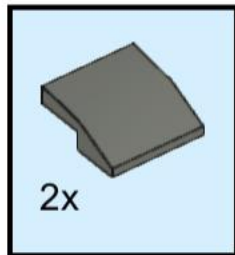
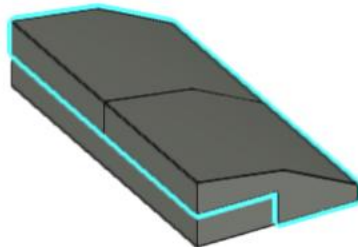

29

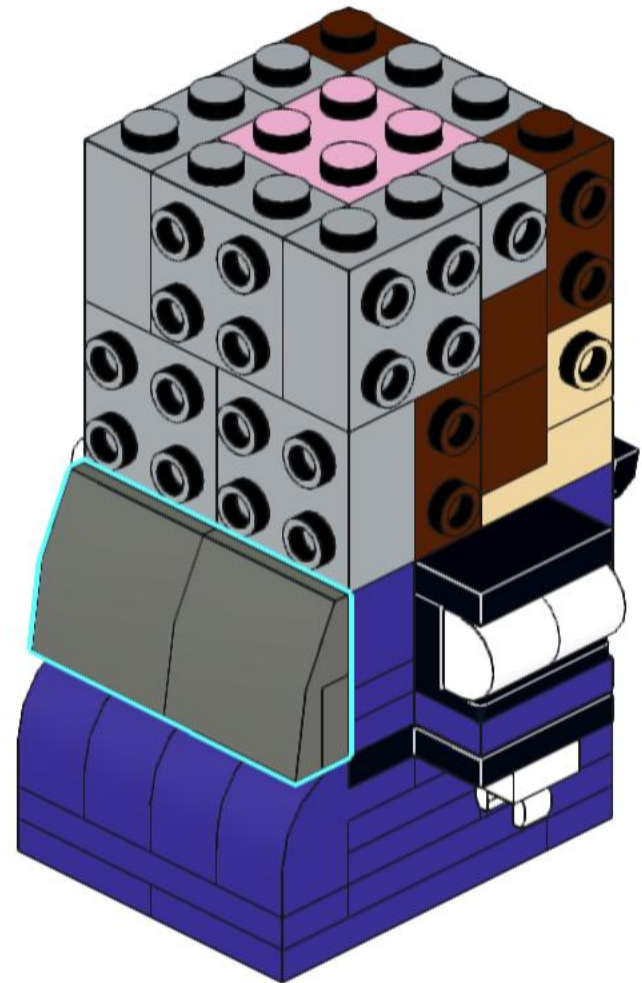

30

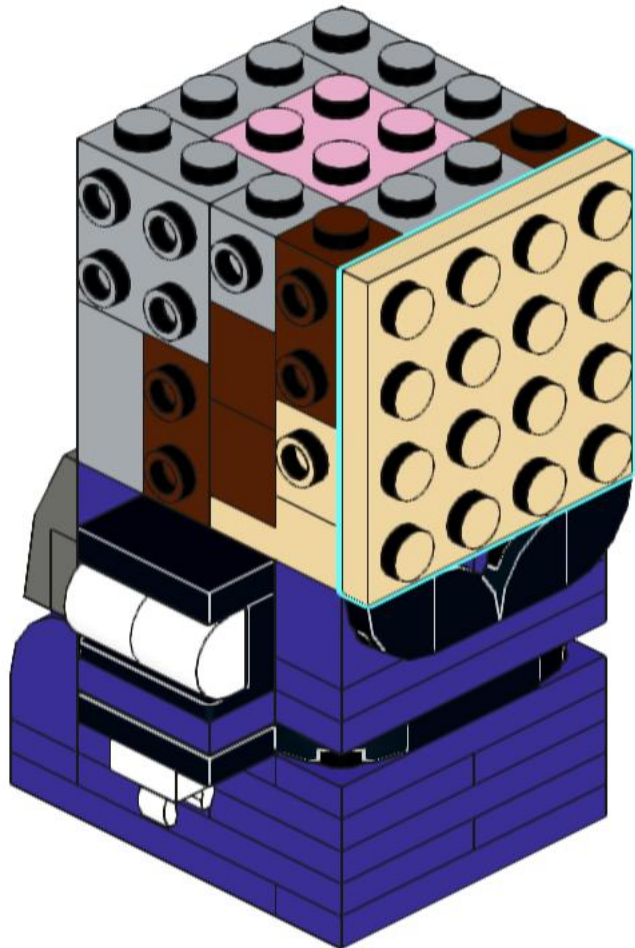
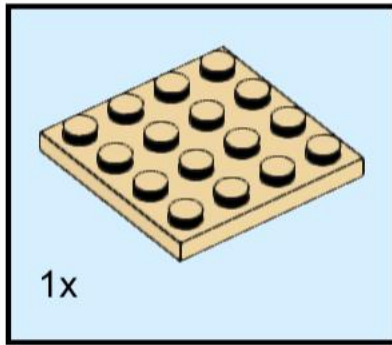

31

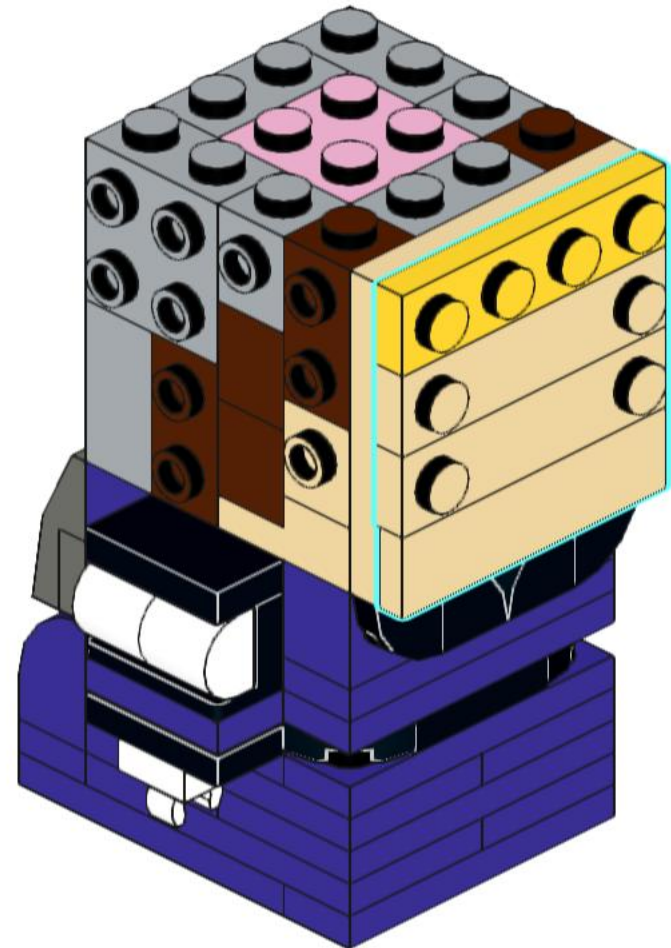
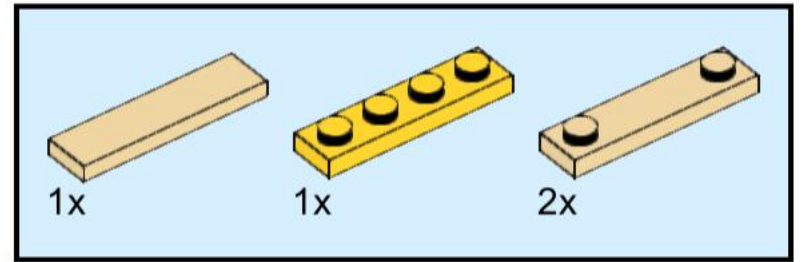

32

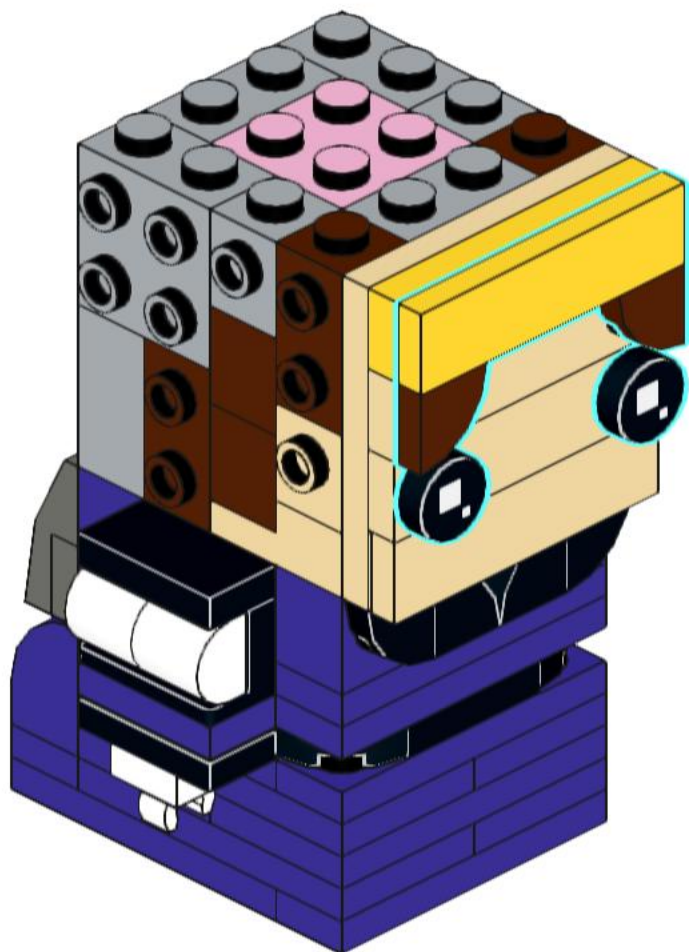
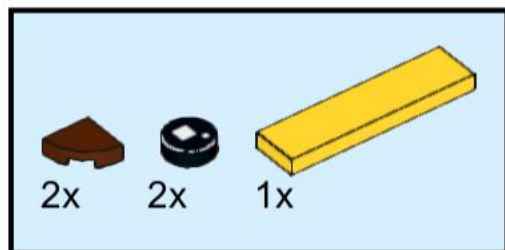

33

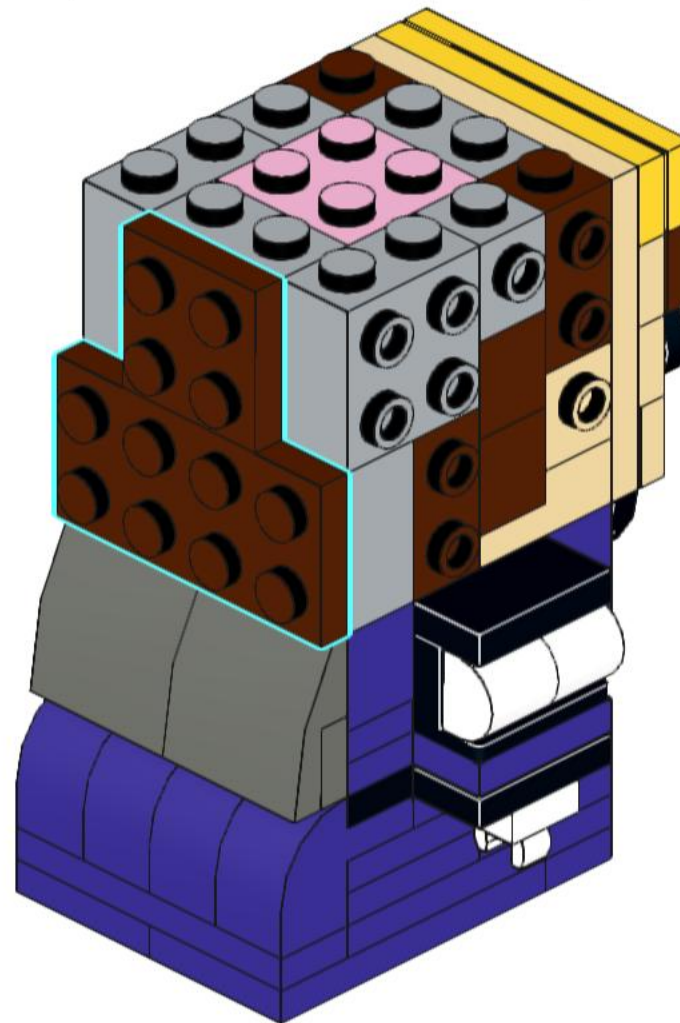
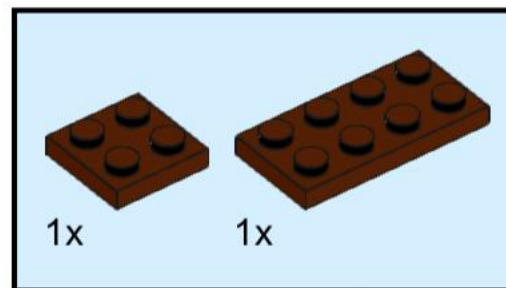

34

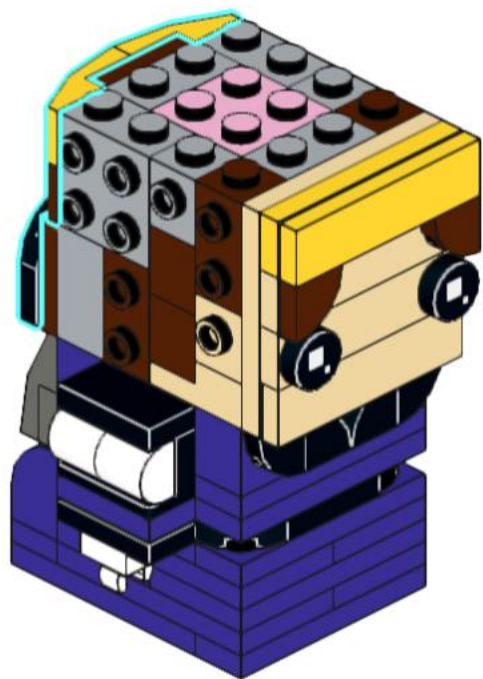
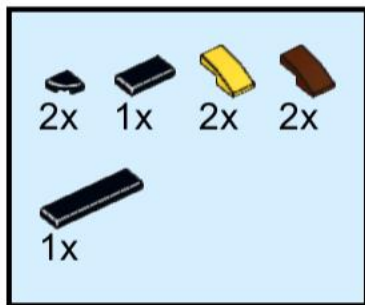

35

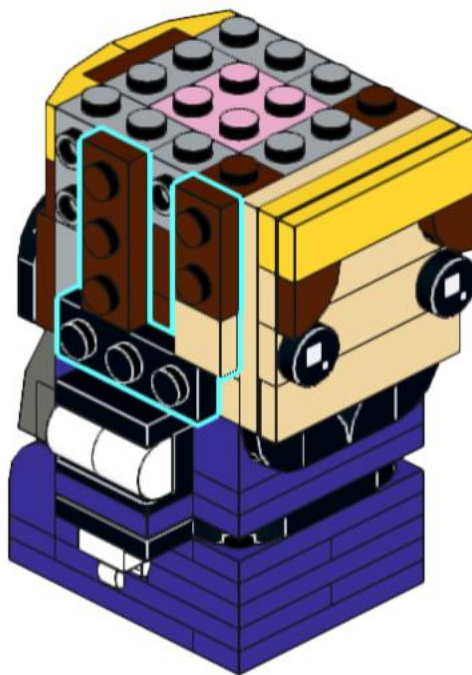
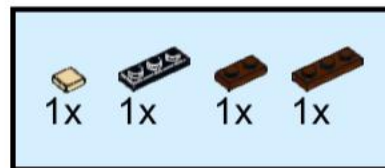

36

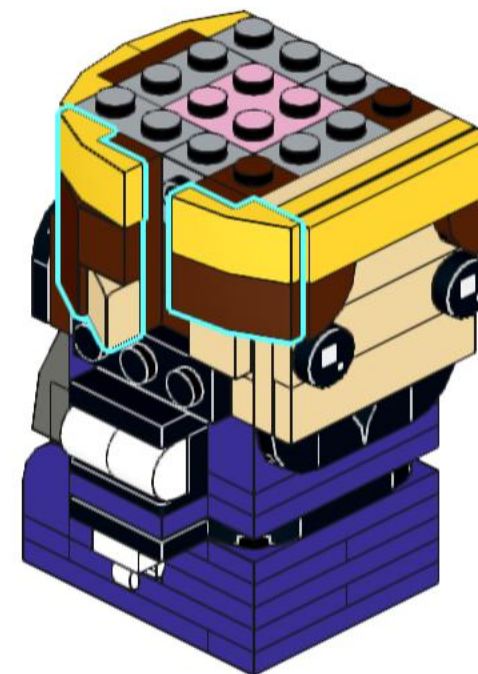
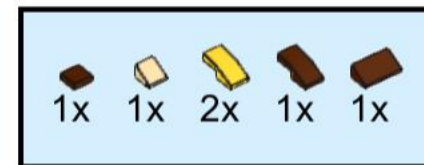

37

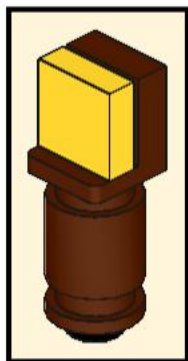
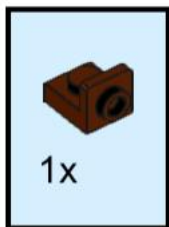

38

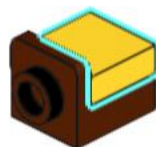
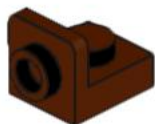
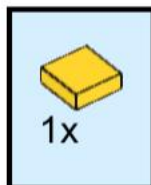

39

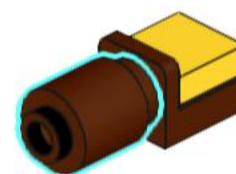
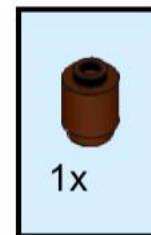

40

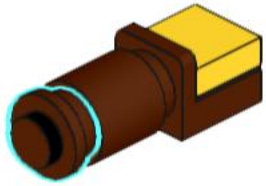
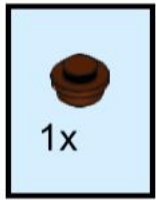

41

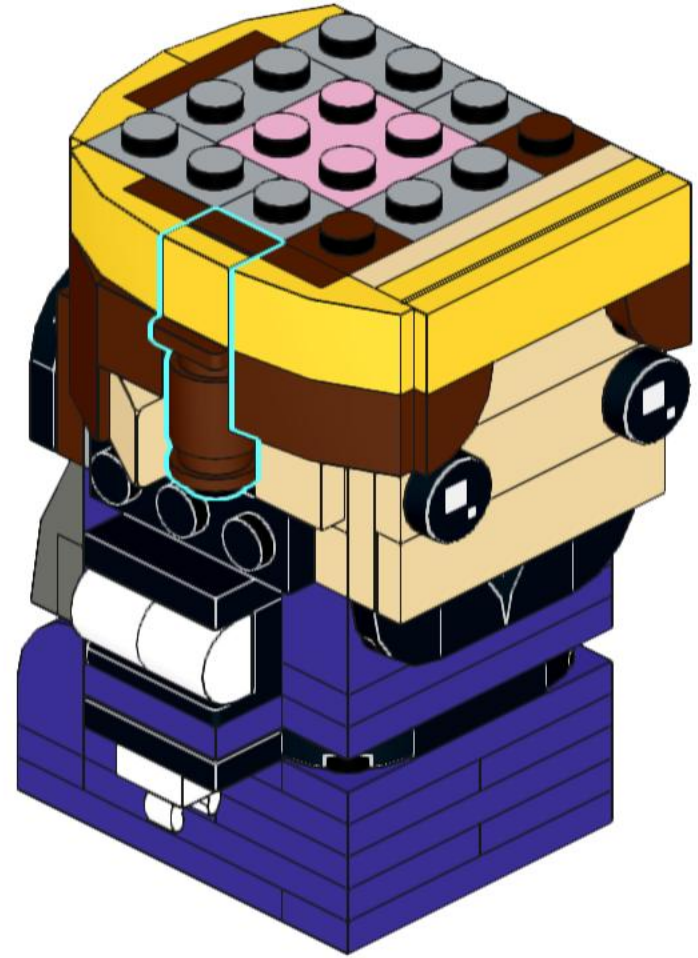

42

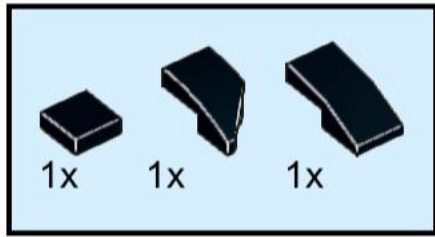

43

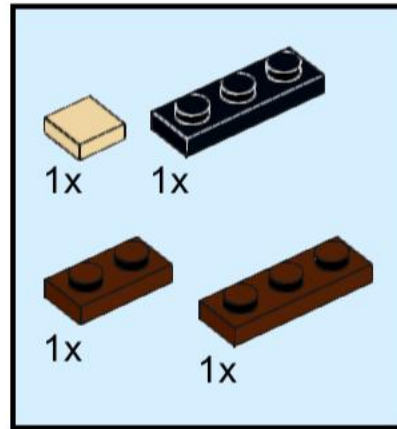

44

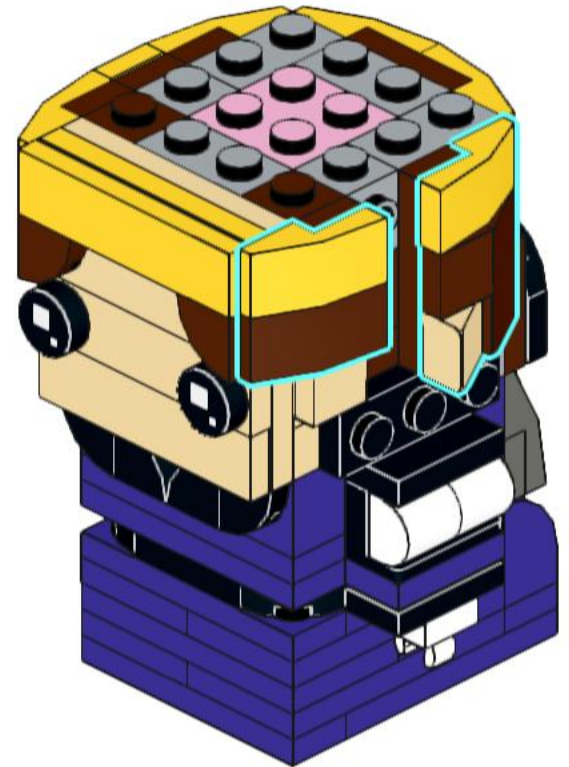
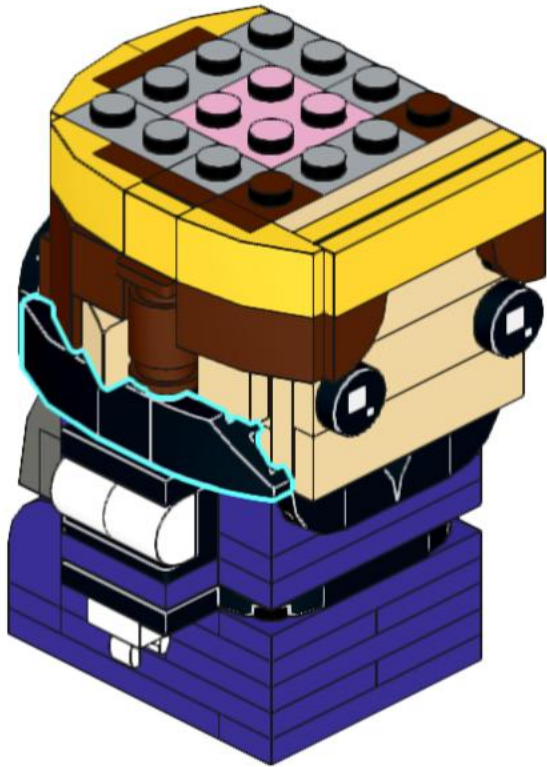
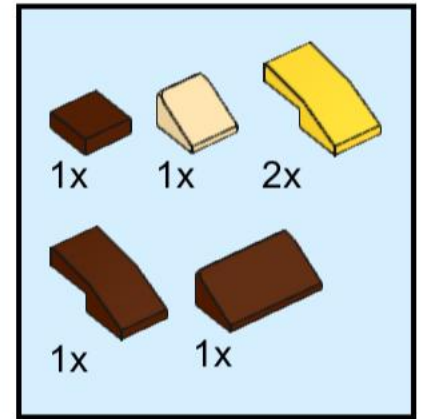

45

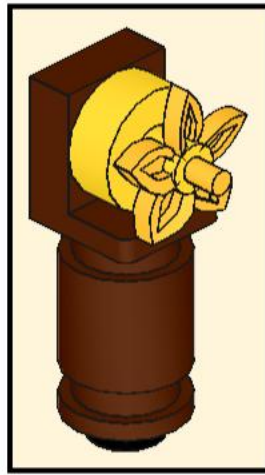
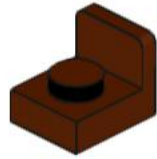
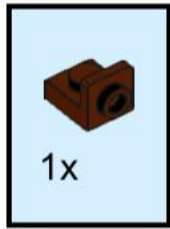

46

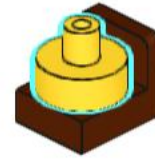
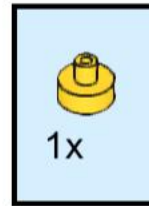

47

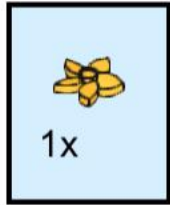

48

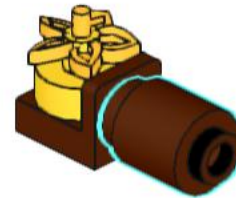
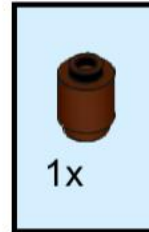

49

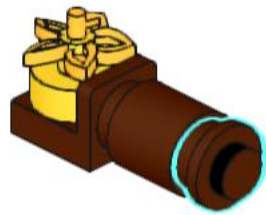
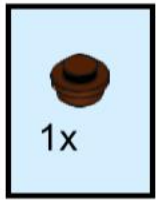

50

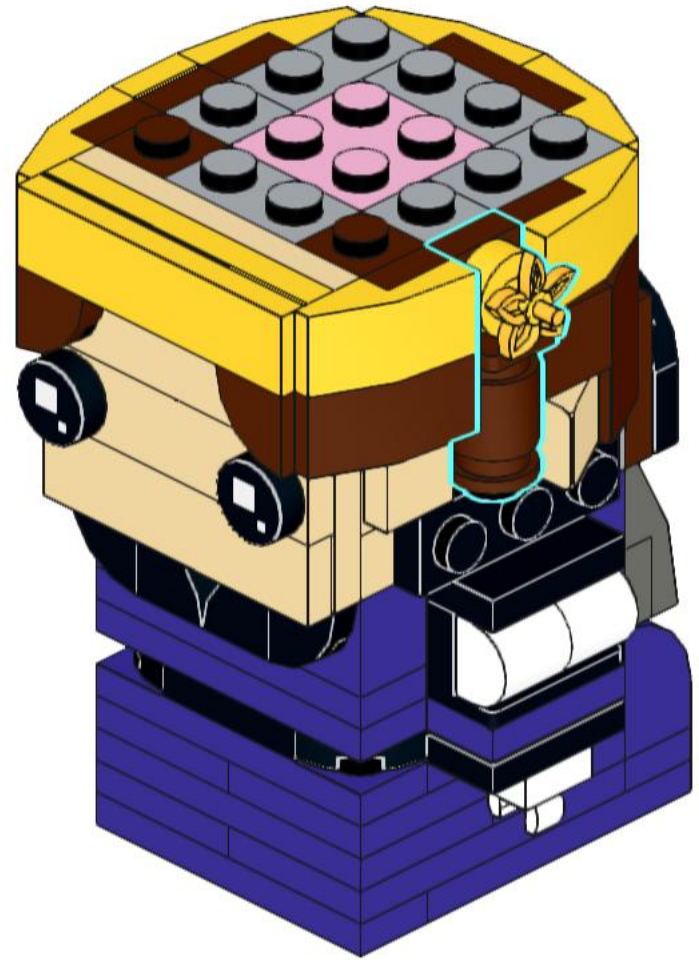

51

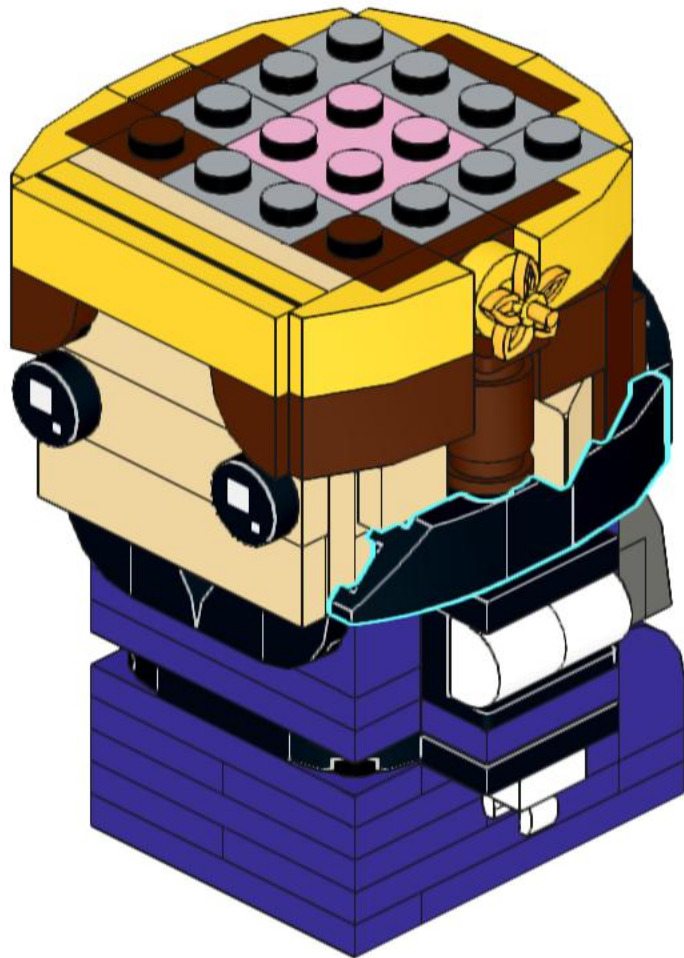
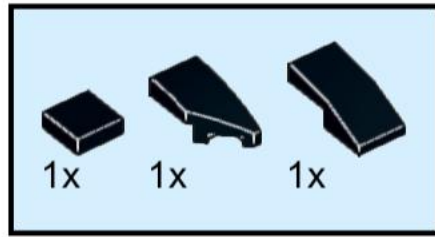

52

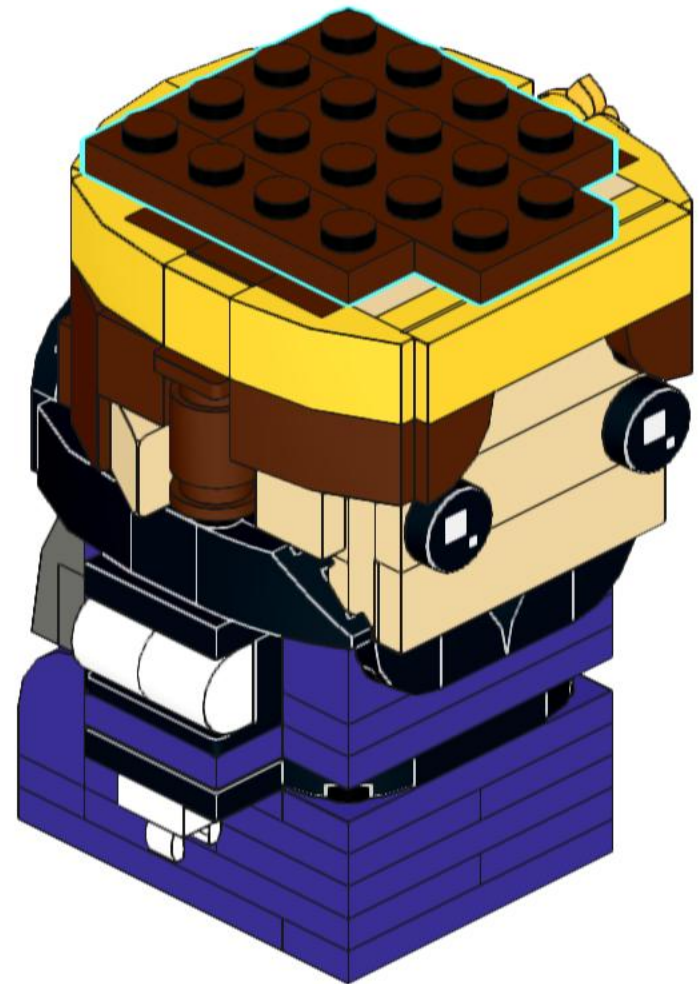
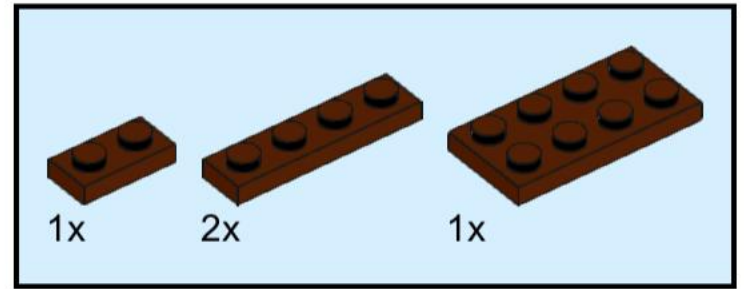

53

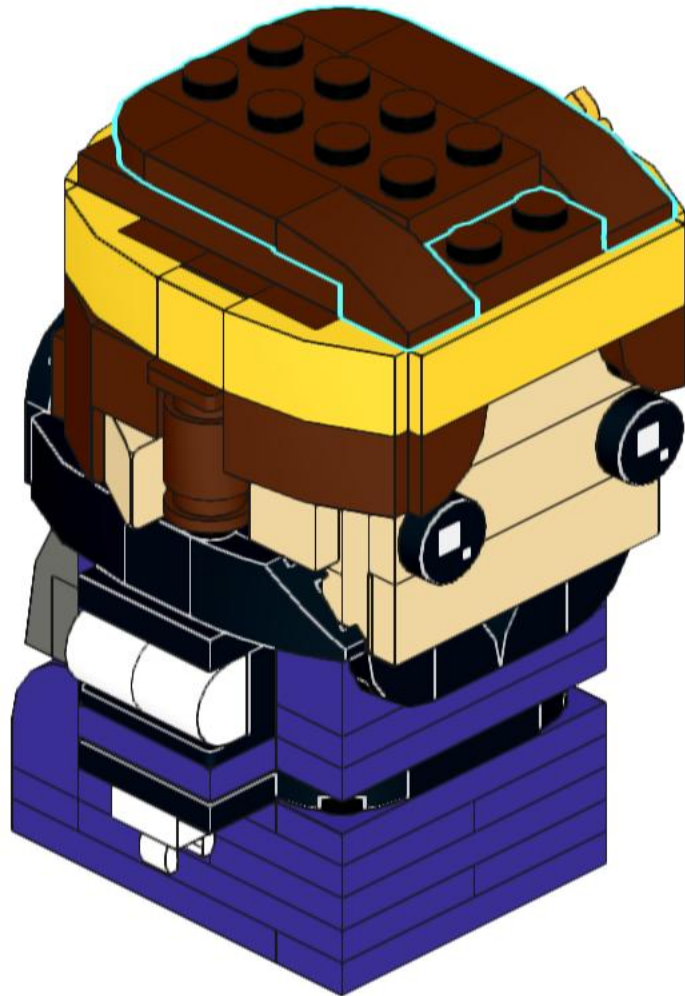
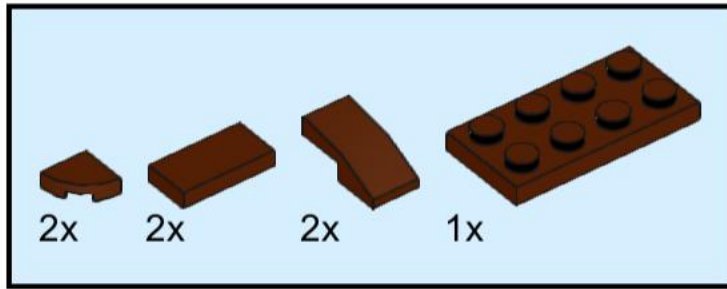

54

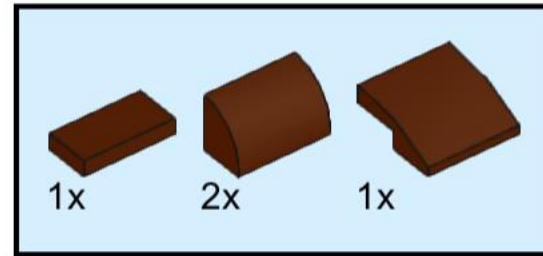

55

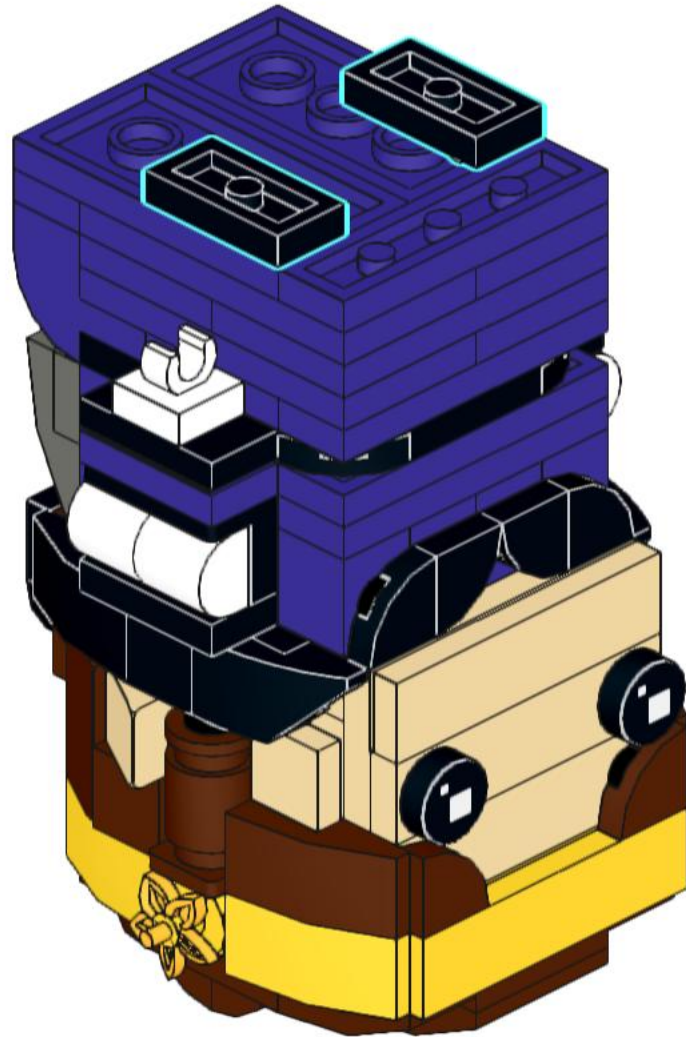
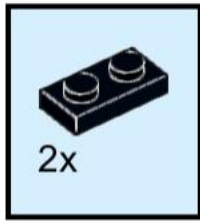

56

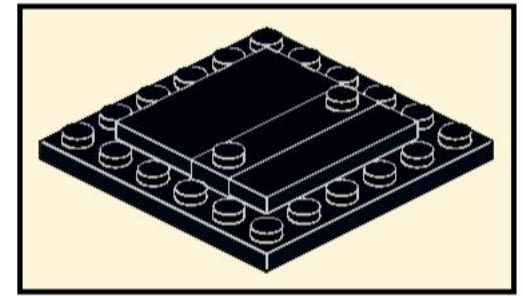
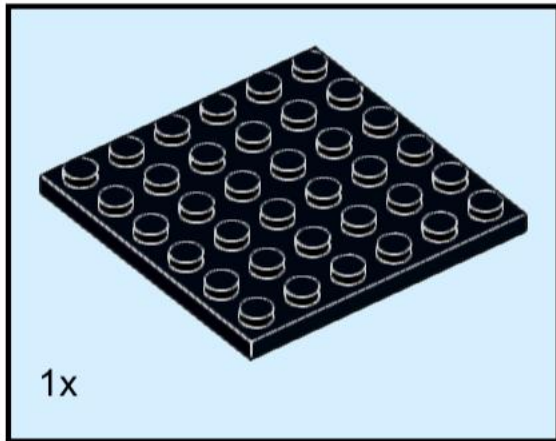

57

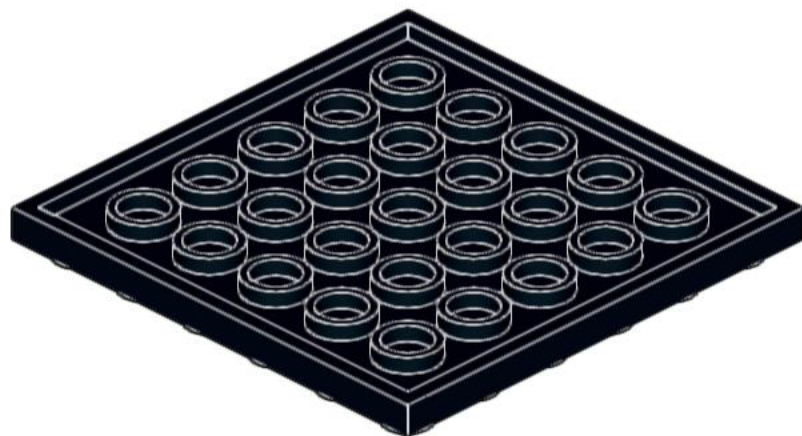
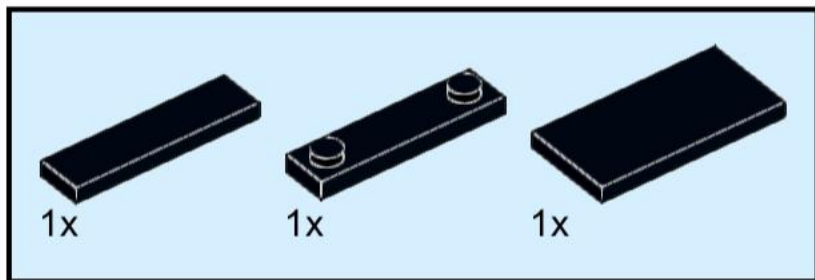

58

